

MGA-30889

40MHz - 2600MHz

Flat Gain High Linearity Gain Block



Data Sheet

Description

Avago Technologies' MGA-30889 is a broadband, flat gain, high linearity gain block MMIC amplifier achieved through the use of Avago Technologies' proprietary 0.25um GaAs Enhancement-mode pHEMT process.

The device required simple dc biasing components to achieve wide bandwidth performance. The temperature compensated internal bias circuit provides stable current over temperature and process threshold voltage variation.

The MGA-30889 is housed inside a low cost RoHS compliant SOT89 industry standard SMT package (4.5 x 4.1 x 1.5 mm).

Component Image

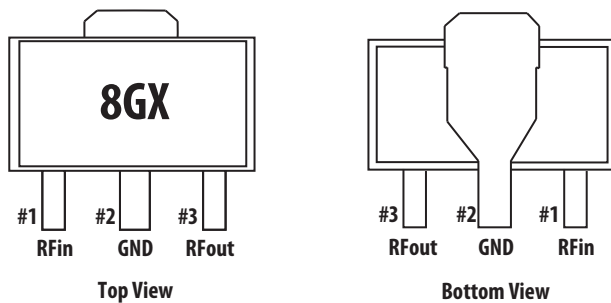

Notes:

Package marking provides orientation and identification

"8G" = Device Code

"X" = Month of Manufacture



Attention: Observe precautions for handling electrostatic sensitive devices.
ESD Machine Model = 50 V
ESD Human Body Model = 400 V
Refer to Avago Application Note A004R:
Electrostatic Discharge, Damage and Control.

Features

- Flat Gain 15dB +/-0.25dB, 40MHz to 2600MHz
- High linearity
- Built in temperature compensated internal bias circuitry
- No RF matching components required
- GaAs E-pHEMT Technology^[1]
- Standard SOT89 package
- Single, Fixed 5V supply
- Excellent uniformity in product specifications
- MSL-2 and Lead-free halogen free
- High MTTF for base station application

Specifications

900MHz; 5V, 65mA (typical)

- 15.5 dB Gain
- 38 dBm Output IP3
- 1.9 dB Noise Figure
- 20 dBm Output Power at 1dB gain compression

1950MHz, 5V, 65mA (typical)

- 15.7 dB Gain
- 36 dBm Output IP3
- 2 dB Noise Figure
- 20.3 dBm Output Power at 1dB gain compression

Applications

- IF amplifier, RF driver amplifier
- General purpose gain block

Note:

1. Enhancement mode technology employs positive gate voltage, thereby eliminating the need of negative gate voltage associated with conventional depletion mode devices.

Absolute Maximum Rating^[1] T_A=25°C

Symbol	Parameter	Units	Absolute Max.
V _{dd,max}	Device Voltage, RF output to ground	V	5.5
P _{in,max}	CW RF Input Power	dBm	20
P _{diss}	Total Power Dissipation ^[3]	W	0.47
T _{j,MAX}	Junction Temperature	°C	150
T _{STG}	Storage Temperature	°C	-65 to 150

Thermal Resistance

Thermal Resistance^[2] $\theta_{JC} = 76^{\circ}\text{C}/\text{W}$
(V_{dd} = 5 V, I_{ds} = 57.5 mA, T_c = 85°C)

Notes:

1. Operation of this device in excess of any of these limits may cause permanent damage.
2. Thermal resistance measured using Infrared measurement technique.
3. This is limited by maximum V_{dd} and I_{ds}. Derate 13.2 mW/°C for T_c > 114°C.

Product Consistency Distribution Charts^[1, 2]

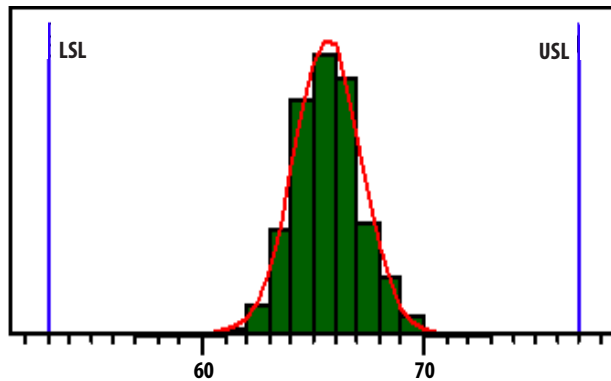

Figure 1. I_{ds}, LSL=53mA, nominal=65mA, USL=77mA

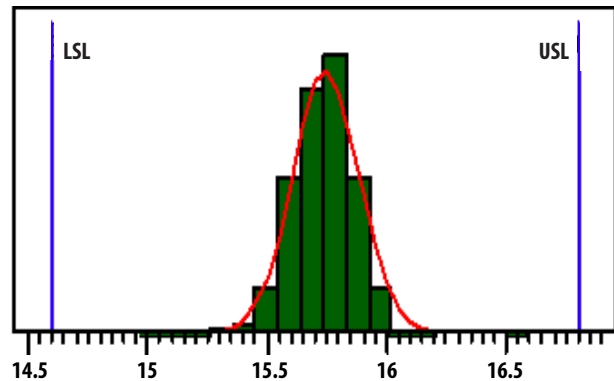

Figure 2. Gain, LSL=14.6dB, nominal=15.7dB, USL=16.8dB

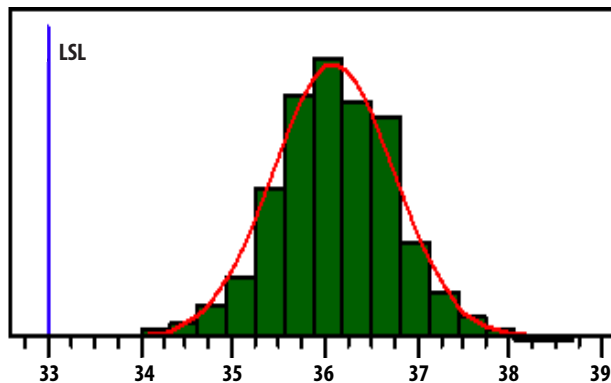

Figure 3. OIP3, LSL=33dBm, nominal=36dBm

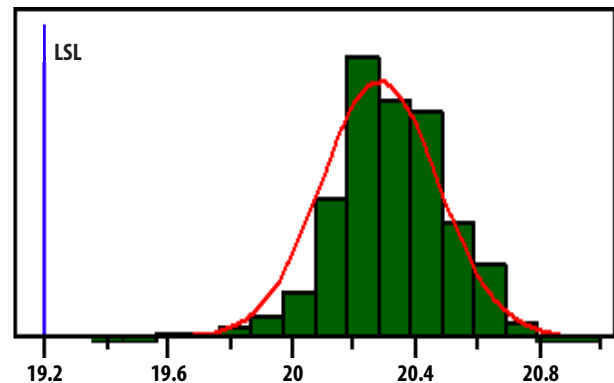

Figure 4. P1dB, LSL=19.2dBm, nominal=20.3dBm

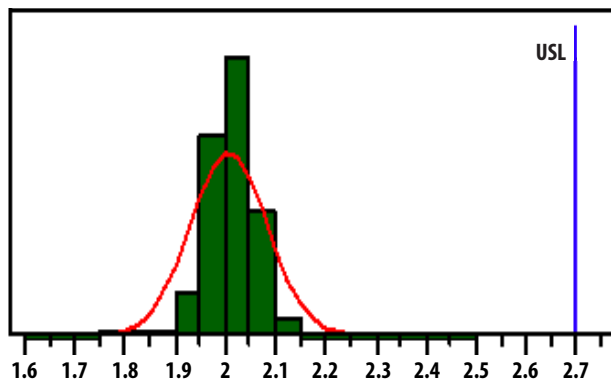

Figure 5. NF, nominal=2dB, USL=2.7dB

Notes:

1. Distribution data sample size is 3000 samples taken from 3 different wafer lots. Future wafers allocated to this product may have nominal values anywhere between the upper and lower limits.
2. Measurements were made on a characterization test board, which represents a trade-off between optimal OIP3, gain and P1dB. Circuit trace losses have not been de-embedded from measurements above.

Electrical Specifications [1]

$T_A = 25^\circ\text{C}$, $V_{dd} = 5\text{V}$

Symbol	Parameter and Test Condition	Frequency	Units	Min.	Typ.	Max.
I_{ds}	Quiescent current	N/A	mA	53	65	77
Gain	Gain	40MHz 900MHz 1950MHz	dB		15.9 15.5 15.7	16.8
OIP3 [2]	Output Third Order Intercept Point	40MHz 900MHz 1950MHz	dBm		37 38 36	-
NF	Noise Figure	40MHz 900MHz 1950MHz	dB		2.0 1.9 2.0	2.7
S11	Input Return Loss, 50 Ω source	40MHz 900MHz 1950MHz	dB		-16 -17 -13	
S22	Output Return Loss, 50 Ω load	40MHz 900MHz 1950MHz	dB		-16 -16.5 -13	
S12	Reverse Isolation	40MHz 900MHz 1950MHz	dB		-17 -17 -22	
OP1dB	Output Power at 1dB Gain Compression	40MHz 900MHz 1950MHz	dBm		21 20 20	-

Notes:

1. Measurements obtained using demo board described in Figure 30 and 31. 40MHz data was taken with 40MHz - 2GHz Application Test Circuit, 900MHz data with 0.2GHz - 2.6GHz Application Test Circuit and 1.95GHz data with 1.5GHz - 2.6GHz Application Test Circuit respectively.
2. OIP3 test condition: $f_{RF1} - f_{RF2} = 10\text{MHz}$ with input power of -15dBm per tone measured at worse side band.
3. Use proper bias, heat sink and de-rating to ensure maximum channel temperature is not exceeded. See absolute maximum ratings and application note (if applicable) for more details.

Typical Performance (40MHz - 2GHz)

$T_A = 25^\circ\text{C}$, $V_{dd} = 5\text{V}$, Input Signal=CW. Application Test Circuit is shown in Figure 30 and Table 1.

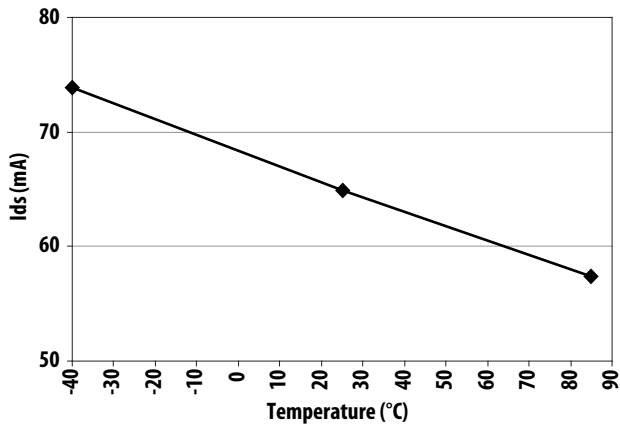

Figure 6. Ids over Temperature

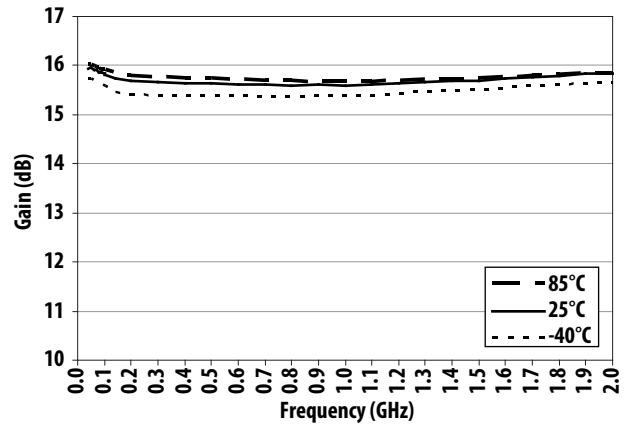

Figure 7. Gain over Frequency and Temperature

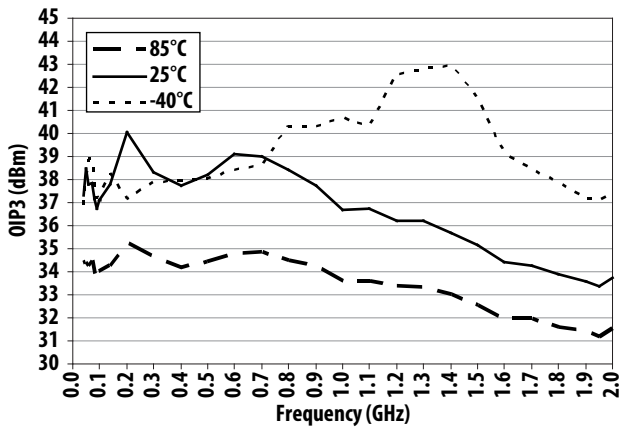

Figure 8. OIP3 over Frequency and Temperature

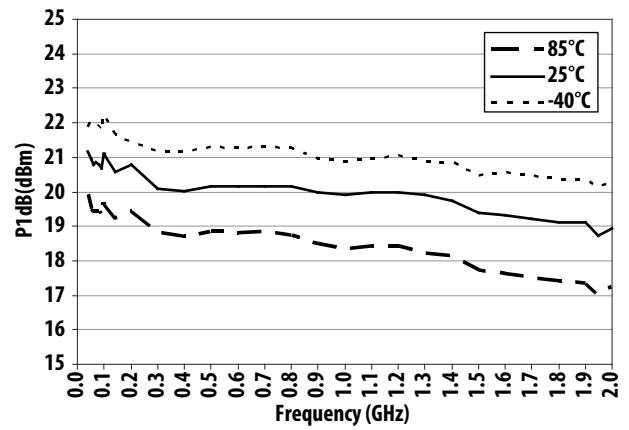

Figure 9. P1dB over Frequency and Temperature

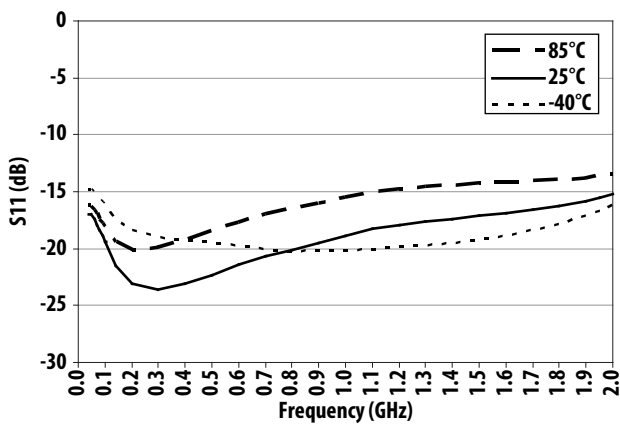

Figure 10. S11 over Frequency and Temperature

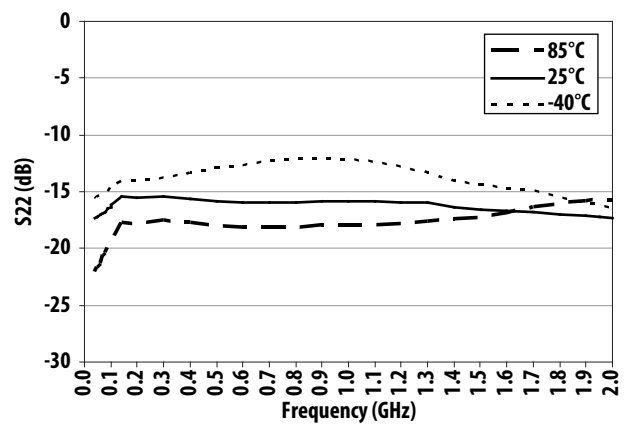

Figure 11. S22 over Frequency and Temperature

Typical Performance (40MHz - 2GHz)

$T_A = 25^\circ\text{C}$, $V_{dd} = 5\text{V}$, Input Signal=CW. Application Test Circuit is shown in Figure 30 and Table 1.

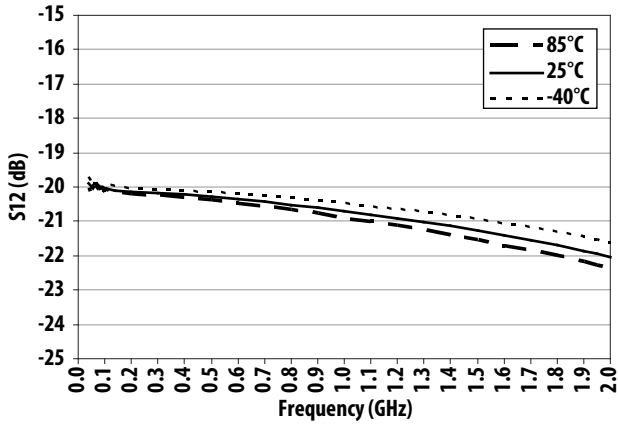

Figure 12. S12 over Frequency and Temperature

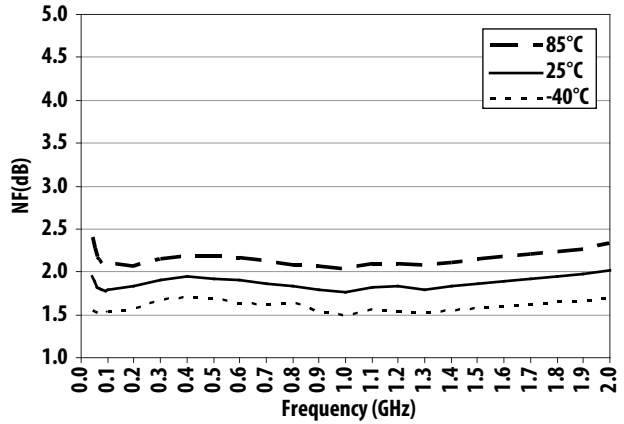

Figure 13. Noise Figure over Frequency and Temperature

Typical Performance (0.2GHz - 2.6GHz)

$T_A = 25^\circ\text{C}$, $V_{dd} = 5\text{V}$, Input Signal=CW. Application Test Circuit is shown in Figure 30 and Table 2.

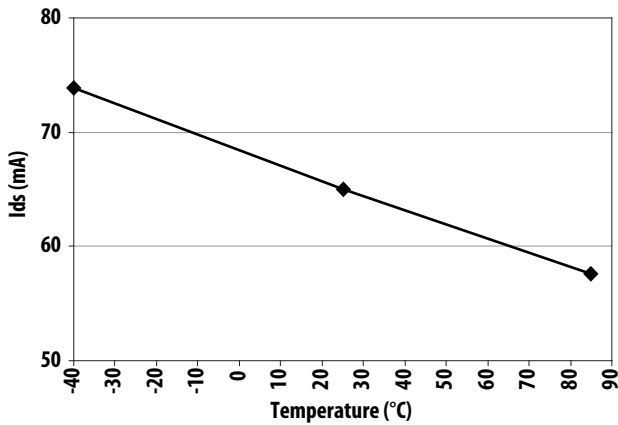

Figure 14. Ids over Temperature

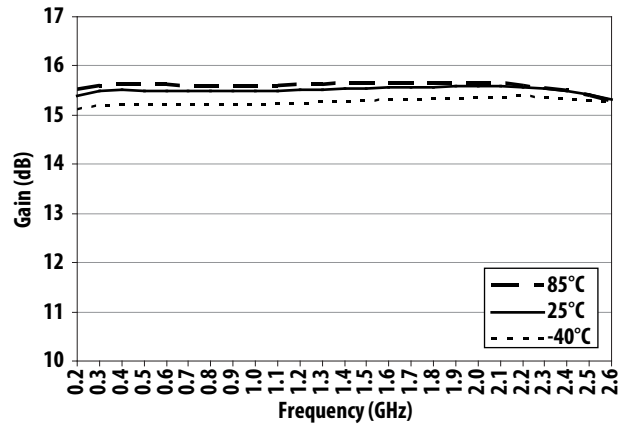

Figure 15. Gain over Frequency and Temperature

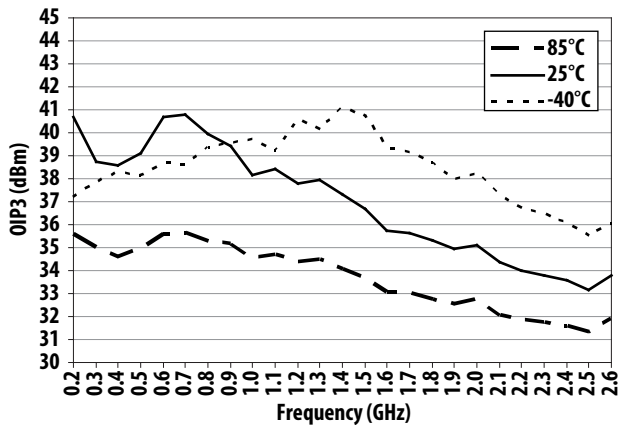

Figure 16. OIP3 over Frequency and Temperature

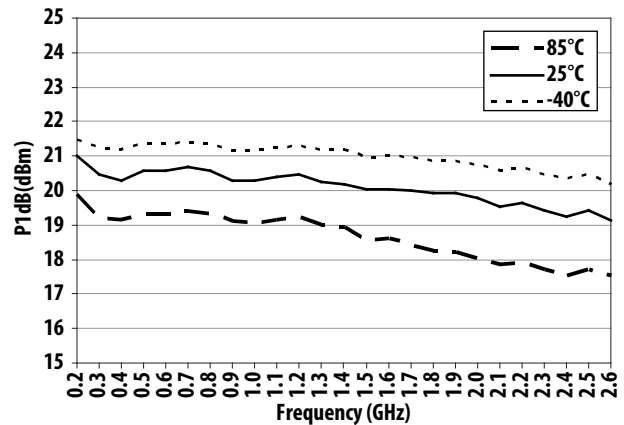

Figure 17. P1dB over Frequency and Temperature

Typical Performance (0.2GHz - 2.6GHz)

T_A = 25°C, V_{dd} = 5V, Input Signal=CW. Application Test Circuit is shown in Figure 30 and Table 2.

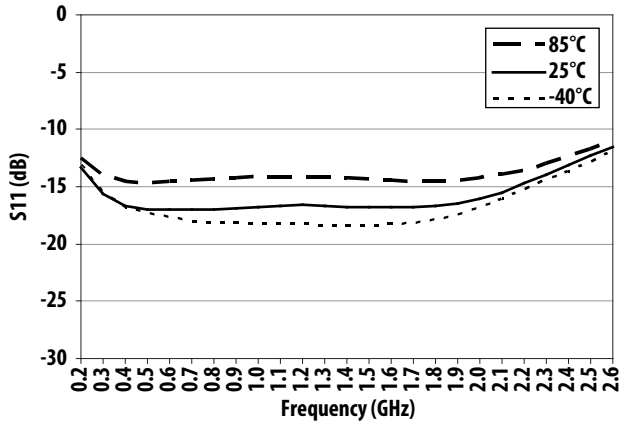

Figure 18. S11 over Frequency and Temperature

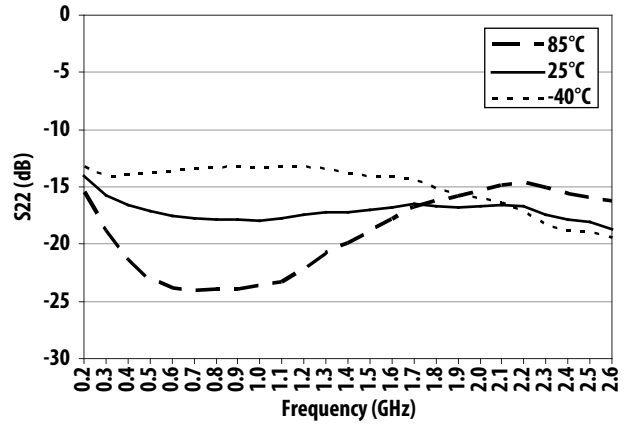

Figure 19. S22 over Frequency and Temperature

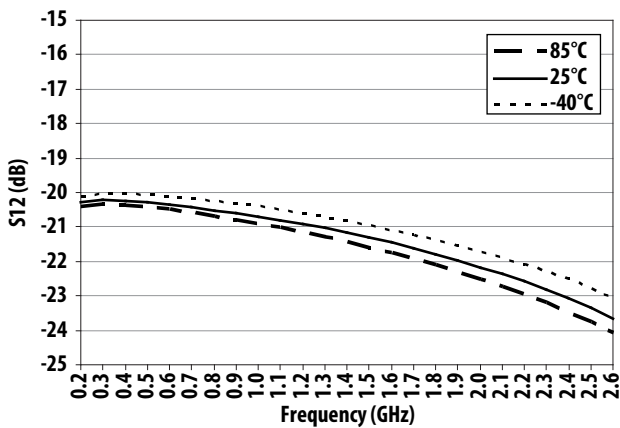

Figure 20. S12 over Frequency and Temperature

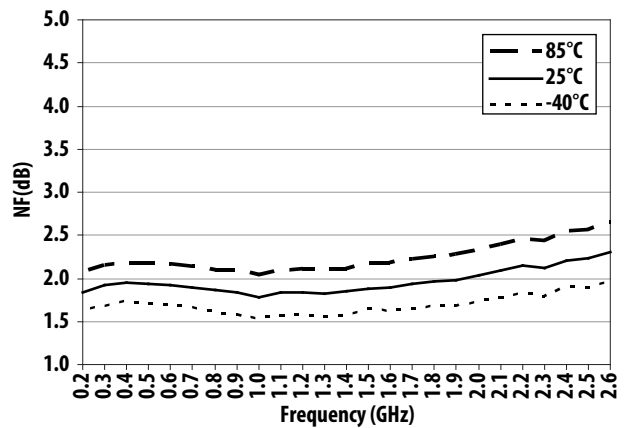

Figure 21. Noise Figure over Frequency and Temperature

Typical Performance (1.5GHz - 2.6GHz)

T_A = 25°C, V_{dd} = 5V, Input Signal=CW. Application Test Circuit is shown in Figure 30 and Table 3.

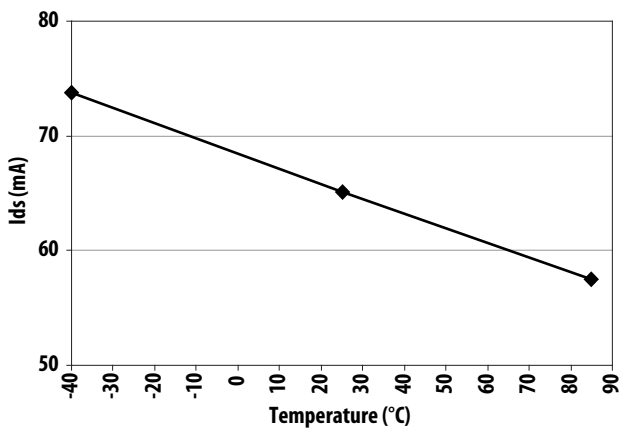

Figure 22. Ids over Temperature

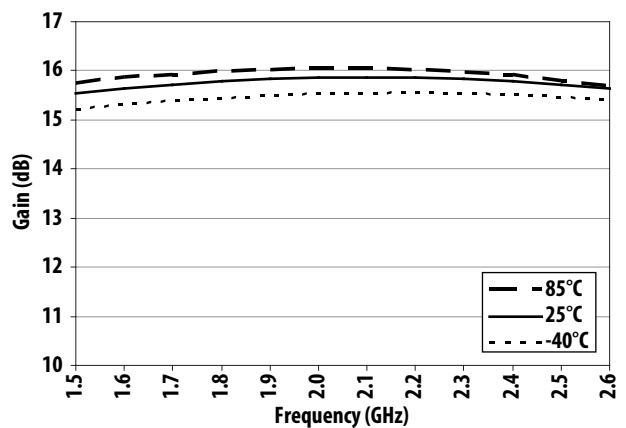

Figure 23. Gain over Frequency and Temperature

Typical Performance (1.5GHz - 2.6GHz)

T_A = 25°C, V_{dd} = 5V, Input Signal=CW. Application Test Circuit is shown in Figure 30 and Table 3.

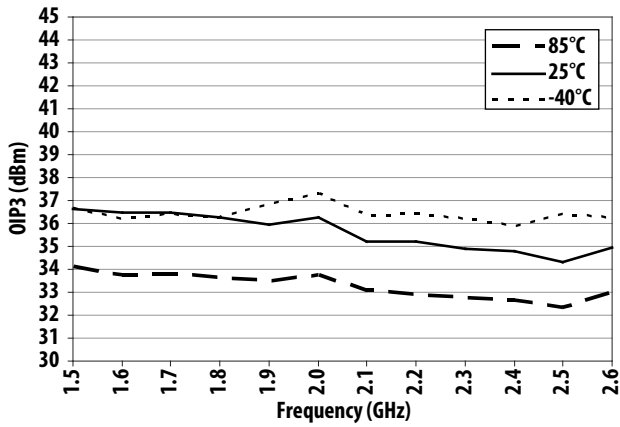

Figure 24. OIP3 over Frequency and Temperature

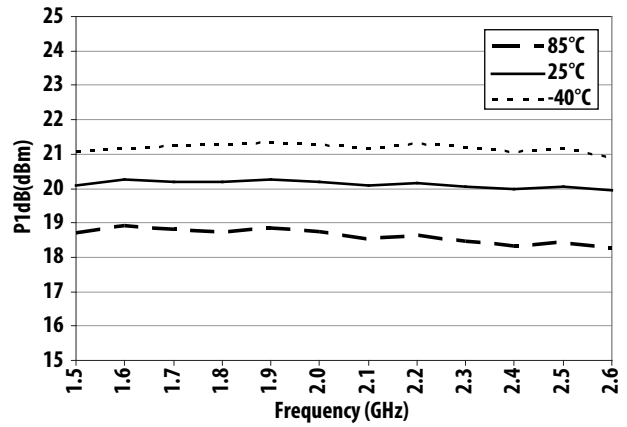

Figure 25. P1dB over Frequency and Temperature

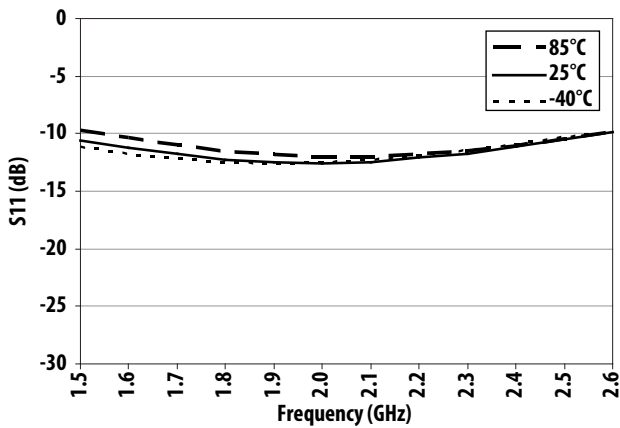

Figure 26. S11 over Frequency and Temperature

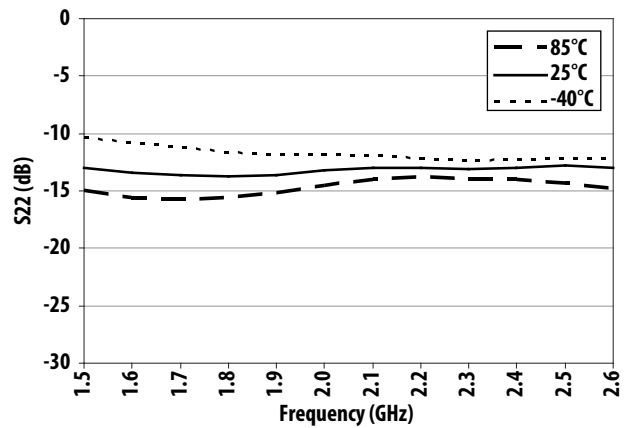

Figure 27. S22 over Frequency and Temperature

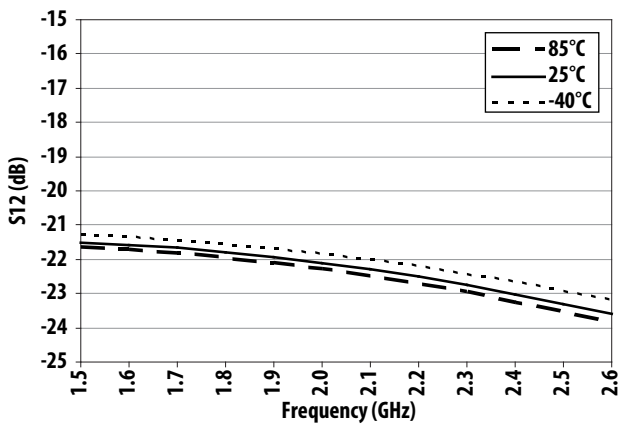

Figure 28. S12 over Frequency and Temperature

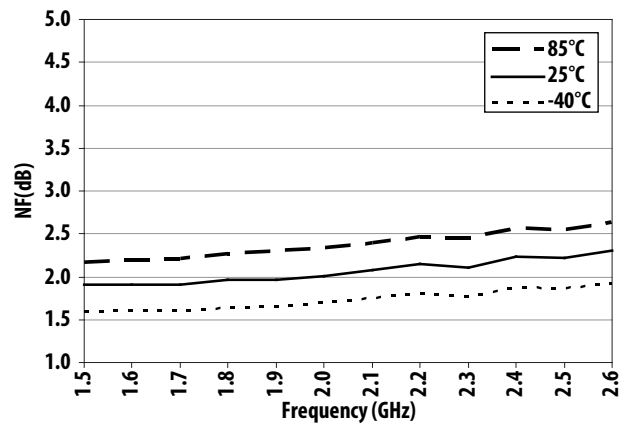
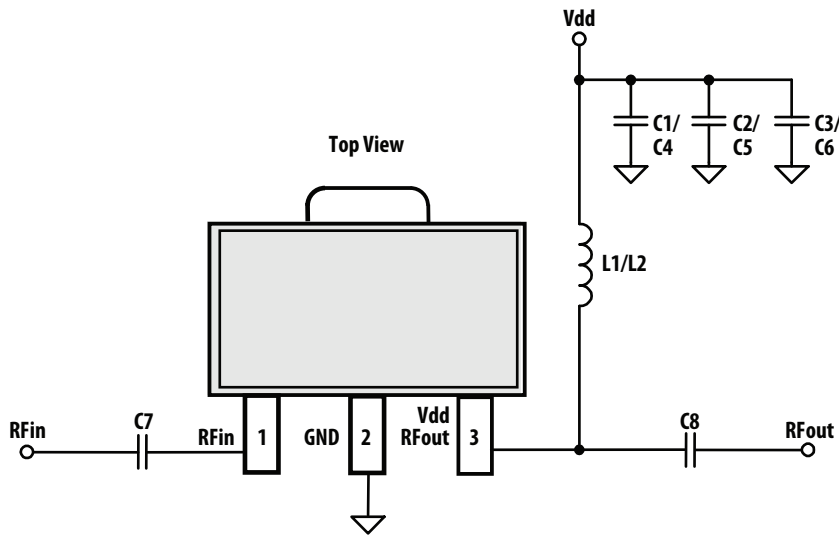

Figure 29. Noise Figure over Frequency and Temperature

Application Schematic Components Table and Demo Board



Note:
 L1, C1, C2, C3 is for BOM 0.2-2.6GHz
 and 1.5-2.6GHz
 L2, C4, C5, C6 is for BOM 40MHz-2GHz

Figure 30. Application Schematic

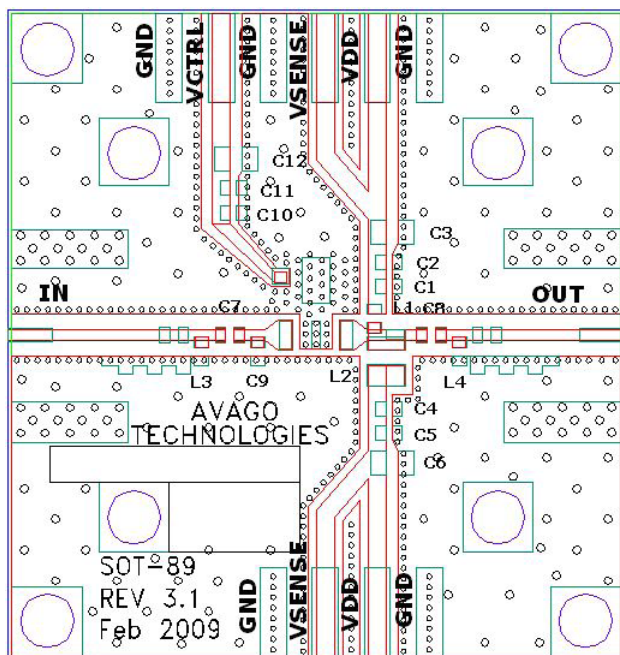

- Recommended PCB material is 10 mils Rogers RO4350, with FR4 backing for mechanical strength.
- Suggested component values may vary according to layout and PCB material.

Figure 31. Demo board Layout

Demo board Part List

Table 1. 40MHz - 2GHz Application Schematic Components

Circuit Symbol	Size	Value	Part Number	Description
L2	0805	820nH	LLQ2012-series (Toko)	Wire Wound Chip Inductor
C4	0402	100pF	GRM1555C1H101JZ01 (Murata)	Ceramic Chip Capacitor
C5	0402	0.1uF	GRM155R71C104KA88D (Murata)	Ceramic Chip Capacitor
C6	0805	2.2uF	GRM21BR61E225KA12L (Murata)	Ceramic Chip Capacitor
C7	0402	0.1uF	GRM155R71C104KA88D (Murata)	Ceramic Chip Capacitor
C8	0402	0.1uF	GRM155R71C104KA88D (Murata)	Ceramic Chip Capacitor

Table 2. 0.2GHz - 2.6GHz Application Schematic Components

Circuit Symbol	Size	Value	Part Number	Description
L1	0603	100nH	LLQ1608-FR10 (Toko)	Wire Wound Chip Inductor
C1	0402	10pF	GRM1555C1H100JZ01 (Murata)	Ceramic Chip Capacitor
C2	0402	0.1uF	GRM155R71C104KA88D (Murata)	Ceramic Chip Capacitor
C3	0805	2.2uF	GRM21BR61E225KA12L (Murata)	Ceramic Chip Capacitor
C7	0402	100pF	GRM1555C1H101JZ01 (Murata)	Ceramic Chip Capacitor
C8	0402	100pF	GRM1555C1H101JZ01 (Murata)	Ceramic Chip Capacitor

Table 3. 1.5GHz - 2.6GHz Application Schematic Components

Circuit Symbol	Size	Value	Part Number	Description
L1	0402	5.6nH	LL1005-FHL5N6 (Toko)	MLC Inductor
C1	0402	100pF	GRM1555C1H101JZ01 (Murata)	Ceramic Chip Capacitor
C2	0402	0.1uF	GRM155R71C104KA88D (Murata)	Ceramic Chip Capacitor
C3	0805	2.2uF	GRM21BR61E225KA12L (Murata)	Ceramic Chip Capacitor
C7	0402	20pF	GRM1555C1H200JZ01 (Murata)	Ceramic Chip Capacitor
C8	0402	20pF	GRM1555C1H200JZ01 (Murata)	Ceramic Chip Capacitor

Test Circuit for S-Parameter and Noise Parameter

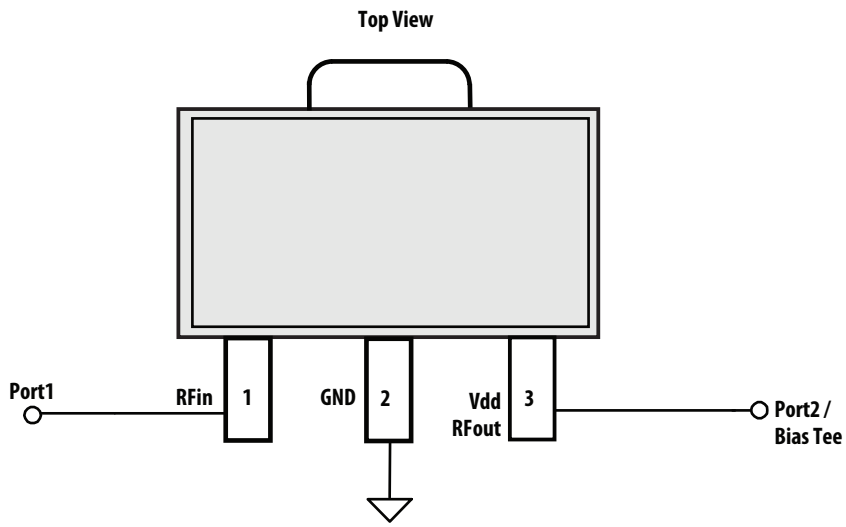

Figure 32. S-parameter and Noise parameter test circuit

Typical S-Parameter (Vdd = 5V, TA = 25°C, 50 ohm)

Freq (GHz)	S11 (dB)	S11 (ang)	S21 (dB)	S21 (ang)	S12 (dB)	S12 (ang)	S22 (dB)	S22 (ang)
0.04	-17.04	-88.23	16.16	167.09	-20.08	6.83	-14.55	-138.35
0.1	-23.82	-99.63	15.83	170.40	-20.02	-1.16	-15.92	-163.34
0.2	-27.02	-106.63	15.78	167.69	-20.03	-7.14	-16.38	-173.98
0.3	-26.83	-116.89	15.78	163.41	-20.05	-12.02	-16.45	-179.28
0.4	-24.42	-127.93	15.78	158.71	-20.08	-16.72	-16.24	176.99
0.5	-22.60	-130.33	15.79	153.85	-20.12	-21.30	-16.34	177.06
0.6	-21.35	-134.41	15.81	148.88	-20.16	-25.84	-16.37	178.09
0.7	-20.18	-140.06	15.83	143.85	-20.21	-30.36	-16.39	178.81
0.8	-19.10	-146.29	15.85	138.73	-20.27	-34.85	-16.40	178.64
0.9	-18.13	-152.78	15.88	133.58	-20.34	-39.29	-16.35	177.88
1	-17.42	-160.67	15.91	128.38	-20.42	-43.88	-16.16	177.12
1.1	-16.72	-166.54	15.96	123.11	-20.50	-48.37	-16.54	175.97
1.2	-16.21	-176.41	16.00	117.79	-20.60	-52.85	-16.29	174.49
1.3	-15.66	173.51	16.03	112.37	-20.70	-57.37	-16.03	172.05
1.4	-15.09	162.73	16.07	106.92	-20.82	-61.94	-15.76	168.90
1.5	-14.41	151.57	16.10	101.34	-20.96	-66.51	-15.42	164.84
1.6	-13.67	140.49	16.12	95.64	-21.12	-71.09	-15.11	160.22
1.7	-12.91	130.11	16.13	89.95	-21.29	-75.69	-14.81	155.66
1.8	-12.12	120.06	16.13	84.16	-21.47	-80.32	-14.56	150.71
1.9	-11.34	110.67	16.12	78.29	-21.68	-84.88	-14.33	145.47
2	-10.60	101.66	16.10	72.45	-21.90	-89.37	-14.14	140.05
2.1	-9.89	93.15	16.06	66.53	-22.14	-93.79	-13.96	134.67
2.2	-9.25	84.93	16.01	60.60	-22.41	-98.15	-13.84	129.50
2.3	-8.70	77.25	15.96	54.75	-22.69	-102.42	-13.80	124.63
2.4	-8.17	69.77	15.88	48.83	-22.98	-106.71	-13.80	119.72
2.5	-7.72	62.66	15.80	43.02	-23.28	-110.71	-13.84	115.08
2.6	-7.32	55.78	15.70	37.21	-23.59	-114.68	-13.93	110.60
2.7	-6.97	48.95	15.61	31.35	-23.93	-118.51	-14.07	106.56
2.8	-6.68	42.26	15.51	25.64	-24.25	-122.20	-14.28	102.99
2.9	-6.44	35.55	15.40	19.84	-24.57	-125.87	-14.56	99.69
3	-6.23	28.95	15.30	14.15	-24.89	-129.40	-14.95	96.77
4	-4.89	-49.49	13.83	-45.76	-28.13	-161.64	-23.03	97.19
5	-2.59	-116.16	10.78	-101.46	-31.11	175.49	-25.89	-152.28
6	-2.03	-163.08	8.27	-146.84	-31.55	155.55	-32.05	-167.12
7	-2.13	126.91	6.05	159.94	-30.84	116.80	-20.70	67.94
8	-1.18	63.71	1.85	107.76	-32.11	72.53	-15.41	31.66
9	-0.90	21.52	-2.15	65.10	-33.21	35.83	-13.70	-6.02
10	-0.96	-35.93	-6.31	19.48	-34.36	-2.85	-11.83	-41.95
11	-0.57	-88.75	-11.99	-20.95	-37.07	-31.83	-8.45	-71.80
12	-0.28	-111.33	-17.53	-45.68	-39.48	-41.74	-5.84	-86.38
13	-0.35	-128.02	-21.20	-67.24	-39.17	-49.14	-4.59	-102.14
14	-0.51	-151.74	-23.85	-91.12	-37.88	-64.15	-4.29	-122.42
15	-0.41	-179.96	-26.91	-116.90	-37.36	-88.21	-3.95	-151.92
16	-0.27	166.93	-30.45	-133.25	-39.05	-106.29	-3.02	-168.71
17	-0.33	157.77	-33.85	-145.37	-42.49	-109.41	-2.77	179.33
18	-0.37	144.27	-37.31	-155.13	-44.53	-97.93	-2.54	169.25
19	-0.58	124.17	-41.44	-156.44	-42.48	-80.86	-3.33	156.65
20	-0.56	103.21	-49.19	-130.39	-40.96	-75.27	-3.99	129.84

Typical Noise Parameters (V_{dd} = 5V, T_A = 25°C, 50 ohm)

Freq (GHz)	F _{min} (dB)	Γ _{opt} Mag	Γ _{opt} Ang	R _n /Z ₀
0.4	1.80	0.036	-102	0.19
0.9	1.70	0.051	-86	0.19
1.0	1.75	0.071	-76	0.20
1.7	1.90	0.11	-52	0.25
1.95	1.93	0.17	-46	0.28
2.0	1.90	0.16	-41	0.29
2.5	1.81	0.24	-19	0.38
3.0	1.85	0.30	3.7	0.49
3.5	1.81	0.40	27	0.55
4.0	2.24	0.45	58	0.54
4.5	2.71	0.47	89	0.50
5.0	3.39	0.55	121	0.43

Part Number Ordering Information

Part Number	No. of Devices	Container
MGA-30889-BLKG	100	7" Tape/Reel
MGA-30889-TR1G	3000	13" Tape/Reel

SOT89 Package Dimensions

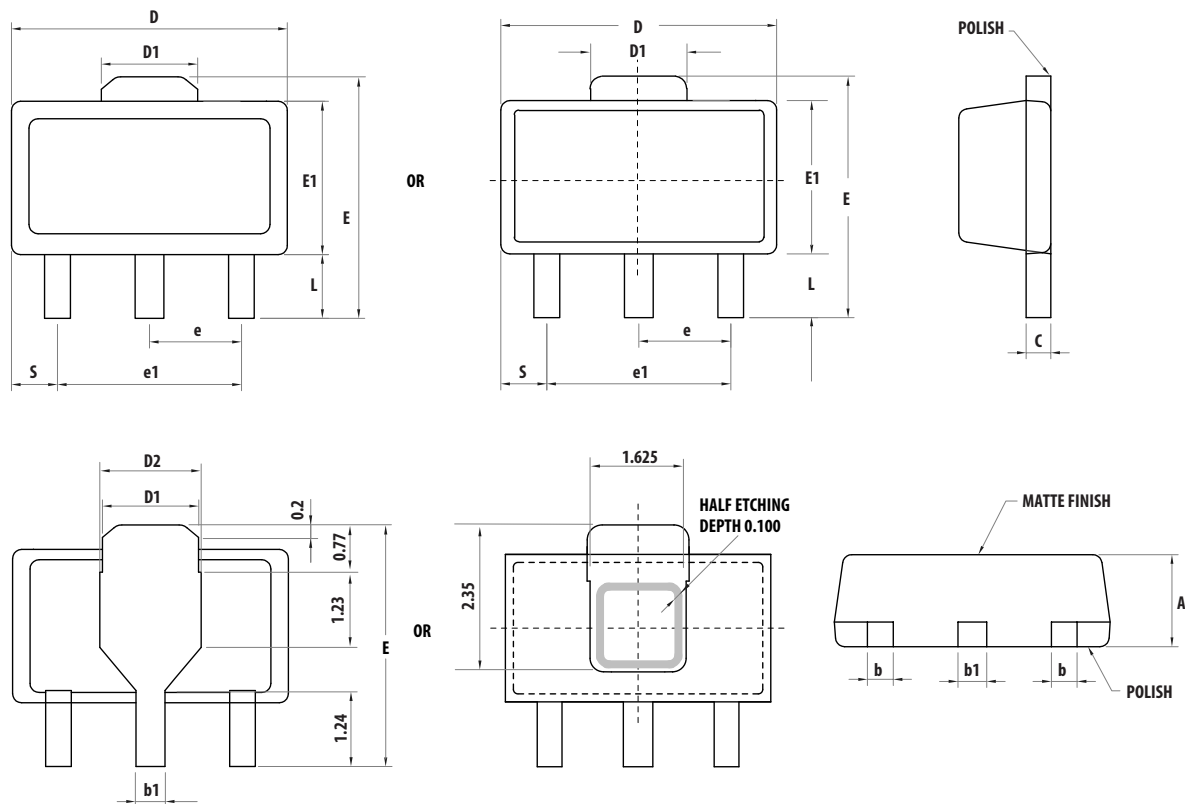

Symbols	Dimensions in mm			Dimensions in inches		
	Minimum	Nominal	Maximum	Minimum	Nominal	Maximum
A	1.40	1.50	1.60	0.055	0.059	0.063
L	0.89	1.04	1.20	0.0350	0.041	0.047
b	0.36	0.42	0.48	0.014	0.016	0.018
b1	0.41	0.47	0.53	0.016	0.018	0.030
C	0.38	0.40	0.43	0.014	0.015	0.017
D	4.40	4.50	4.60	0.173	0.177	0.181
D1	1.40	1.60	1.75	0.055	0.062	0.069
D2	1.45	1.65	1.80	0.055	0.062	0.069
E	3.94	-	4.25	0.155	-	0.167
E1	2.40	2.50	2.60	0.094	0.098	0.102
e1	2.90	3.00	3.10	0.114	0.118	0.122
S	0.65	0.75	0.85	0.026	0.030	0.034
e	1.40	1.50	1.60	0.054	0.059	0.063

Device Orientation

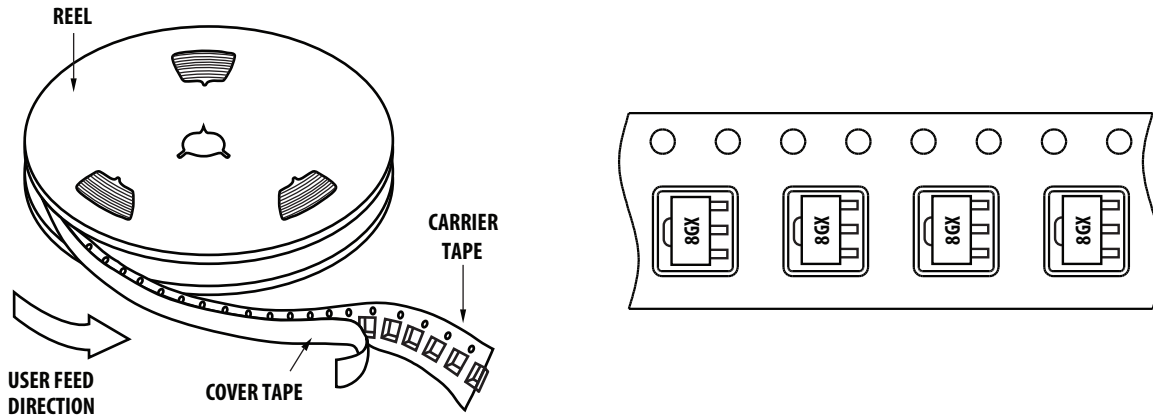

Tape Dimensions

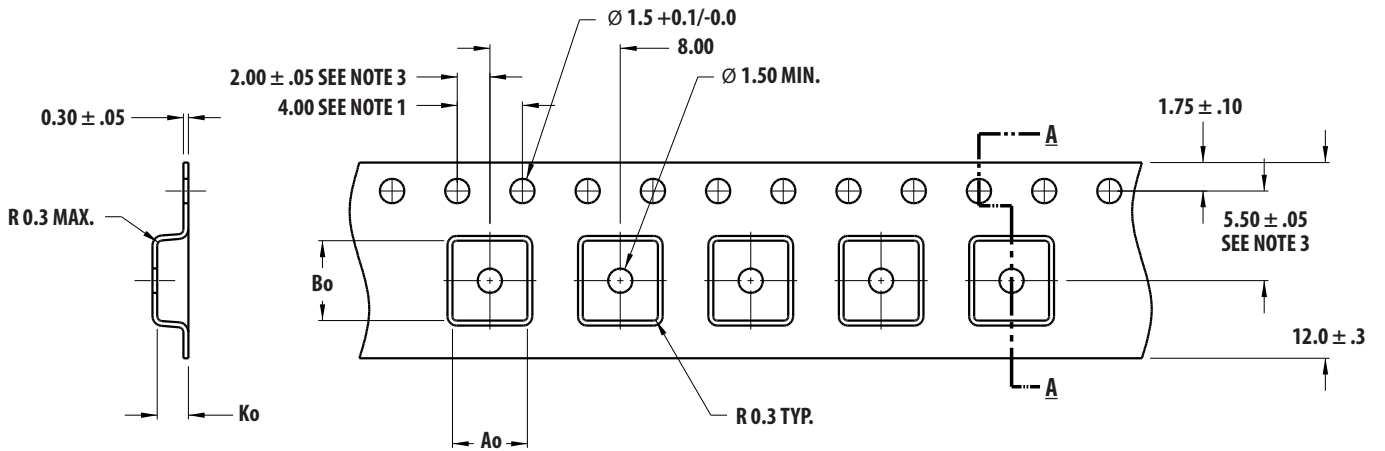

Ao = 4.60
Bo = 4.90
Ko = 1.90

DIMENSIONS IN MM

NOTES:

1. 10 SPROCKET HOLE PITCH CUMULATIVE TOLERANCE ± 0.2
2. CAMBER IN COMPLIANCE WITH EIA 481
3. POCKET POSITION RELATIVE TO SPROCKET HOLE MEASURED AS TRUE POSITION OF POCKET, NOT POCKET HOLE

Reel Dimensions – 13" Reel

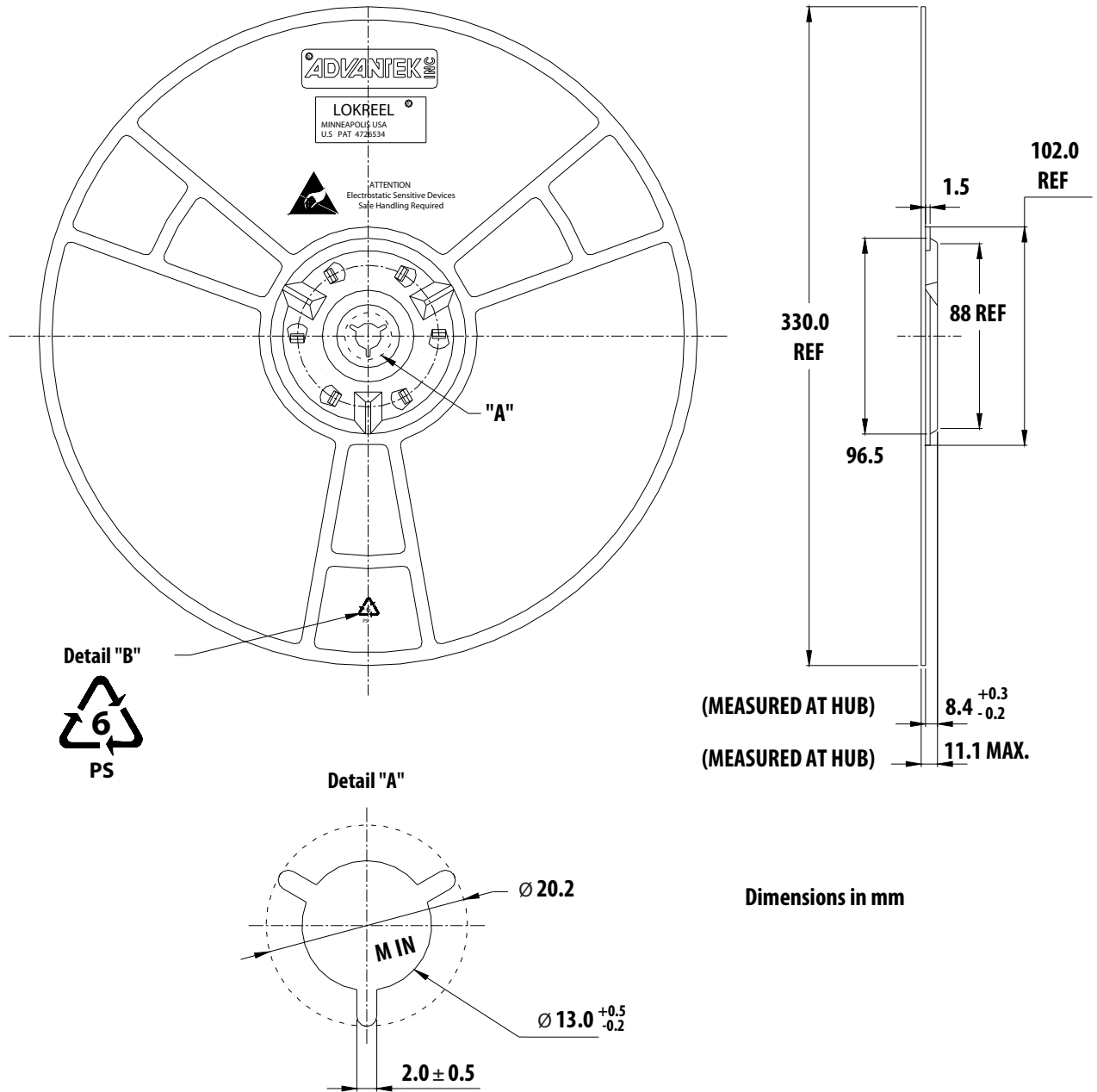

For product information and a complete list of distributors, please go to our web site: www.avagotech.com

Avago, Avago Technologies, and the A logo are trademarks of Avago Technologies in the United States and other countries. Data subject to change. Copyright © 2005-2013 Avago Technologies. All rights reserved. AV02-2250EN - November 11, 2013

