

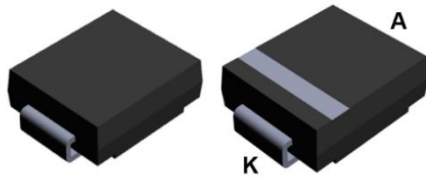
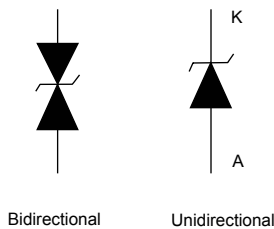

Automotive 1500 W TVS in SMC

 SMC
(JEDEC DO-214AB)

Features

- AEC-Q101 qualified 
- Peak pulse power: 1500 W (10/1000 μ s) and 10 kW (8/20 μ s)
- Stand-off voltage range from 5.8 V to 70 V
- Unidirectional and bidirectional types
- Low leakage current: 0.2 μ A at 25 °C and 1 μ A at 85 °C
- Operating T_j max: 150 °C
- High power capability at T_j max.: up to 1250 W (10/1000 μ s)
- Lead finishing: matte tin plating

Complies with the following standards

- UL94, V0
- J-STD-020 MSL level 1
- J-STD-002, JESD 22-B102 E3 and MIL-STD-750, method 2026 solderable matte tin plated leads
- JESD-201 class 2 whisker test
- IPC7531 footprint
- JEDEC registered package outline
- IEC 61000-4-4 level 4:
 - 4 kV
- ISO10605, IEC 61000-4-2, C= 150 pF - R = 330 Ω exceeds level 4:
 - 30 kV (air discharge)
 - 30 kV (contact discharge)
- ISO10605 - C = 330 pF, R = 330 Ω exceeds level 4:
 - 30 kV (air discharge)
 - 30 kV (contact discharge)
- ISO7637-2 (Not applicable to parts with stand-off voltage lower than battery voltage)
 - Pulse1: $V_S = -150$ V
 - Pulse 2a: $V_S = +112$ V
 - Pulse 3a: $V_S = -220$ V
 - Pulse 3b: $V_S = +150$ V

Product status link

[SM15T6V8AY](#), [SM15T6V8CAY](#),
[SM15T7V5AY](#), [SM15T7V5CAY](#),
[SM15T10AY](#), [SM15T10CAY](#),
[SM15T12AY](#), [SM15T12CAY](#),
[SM15T15AY](#), [SM15T15CAY](#),
[SM15T18AY](#), [SM15T18CAY](#),
[SM15T22AY](#), [SM15T22CAY](#),
[SM15T24AY](#), [SM15T24CAY](#),
[SM15T27AY](#), [SM15T27CAY](#),
[SM15T30AY](#), [SM15T30CAY](#),
[SM15T33AY](#), [SM15T33CAY](#),
[SM15T36AY](#), [SM15T36CAY](#),
[SM15T39AY](#), [SM15T39CAY](#),
[SM15T47AY](#), [SM15T47CAY](#),
[SM15T56AY](#), [SM15T56CAY](#),
[SM15T58AY](#), [SM15T68CAY](#),
[SM15T75AY](#), [SM15T75CAY](#),
[SM15T82AY](#), [SM15T82CAY](#)

Description

The SM15TY series are designed to protect sensitive automotive circuits against surges defined in ISO 7637-2 and against electrostatic discharges according to ISO 10605.

The Planar technology makes it compatible with high-end circuits where low leakage current and high junction temperature are required to provide long term reliability and stability.

1 Characteristics

Table 1. Absolute maximum ratings ($T_{amb} = 25\text{ }^{\circ}\text{C}$)

Symbol	Parameter	Value	Unit
V_{PP}	Peak pulse voltage	ISO10605 (C = 330 pF, R = 330 Ω):	
		Contact discharge	30
		Air discharge	30
		ISO10605 / IEC 61000-4-2 (C = 150 pF, R = 330 Ω)	
	Contact discharge	30	
	Air discharge	30	
P_{PP}	Peak pulse power dissipation	10/1000 μs , T_j initial = T_{amb}	W
T_{stg}	Storage temperature range	-65 to +150	$^{\circ}\text{C}$
T_j	Operating junction temperature range	-55 to +150	$^{\circ}\text{C}$
T_L	Maximum lead temperature for soldering during 10 s	260	$^{\circ}\text{C}$

Figure 1. Electrical characteristics - parameter definitions

Figure 2. Pulse definition for electrical characteristics

Table 2. Electrical characteristics - parameter values ($T_{amb} = 25\text{ }^{\circ}\text{C}$, unless otherwise specified)

Type	I_{RM} max at V_{RM}			V_{BR} at $I_{BR}^{(1)}$				10 / 1000 μs			8 / 20 μs			αT
								$V_{CL}^{(2)(3)}$	$I_{PP}^{(4)}$	R_D	$V_{CL}^{(2)(3)}$	$I_{PP}^{(4)}$	R_D	
	25 $^{\circ}\text{C}$	85 $^{\circ}\text{C}$		Min.	Typ.	Max.		Max.		Max.	Max.	Max.	Max.	
	μA	V		V			mA	V	A	Ω	V	A	Ω	$10^{-4}/^{\circ}\text{C}$
SM15T6V8AY/CAY	500	2000	5.80	6.45	6.8	7.14	10	10.5	143	0.023	13.4	746	0.008	5.7
SM15T7V5AY/CAY	250	1000	6.40	7.13	7.5	7.88	10	11.3	132	0.026	14.5	690	0.01	6.1
SM15T10AY/CAY	10	50	8.55	9.5	10	10.5	1	14.5	103	0.039	18.6	538	0.015	7.3
SM15T12AY/CAY	0.2	1	10.2	11.4	12	12.6	1	16.7	90	0.046	21.7	461	0.02	7.8
SM15T15AY/CAY	0.2	1	12.8	14.3	15	15.8	1	21.2	71	0.076	27.2	368	0.031	8.4
SM15T18AY/CAY	0.2	1	15.3	17.1	18	18.9	1	25.2	59.5	0.106	32.5	308	0.044	8.8
SM15T22AY/CAY	0.2	1	18.8	20.9	22	23.1	1	30.6	49	0.153	39.3	254	0.064	9.2
SM15T24AY/CAY	0.2	1	20.5	22.8	24	25.2	1	33.2	45	0.178	42.8	234	0.075	9.4
SM15T27AY/CAY	0.2	1	23.1	25.7	27	28.4	1	37.5	40	0.228	48.3	207	0.076	9.6
SM15T30AY/CAY	0.2	1	25.6	28.5	30	28.4	1	41.5	36	0.278	53.5	187	0.12	9.7
SM15T33AY/CAY	0.2	1	28.2	31.4	33	34.7	1	45.7	33	0.333	59	169	0.14	9.8
SM15T36AY/CAY	0.2	1	30.8	34.2	36	37.8	1	49.9	30	0.403	64.3	156	0.17	9.9
SM15T39AY/CAY	0.2	1	33.3	37.1	39	41.0	1	53.9	28	0.461	69.7	143	0.2	10
SM15T47AY/CAY	0.2	1	40.2	44.7	47	49.4	1	64.5	23.2	0.653	84	119	0.291	10.1
SM15T56AY/CAY	0.2	1	48	53.3	56	58.9	1	77.4	20	0.925	100	100	0.411	10.3
SM15T68AY/CAY	0.2	1	58.1	64.6	68	71.4	1	92	16.3	1.26	121	83	0.6	10.4
SM15T75AY/CAY	0.2	1	64.1	71.3	75	78.8	1	103	14.6	1.66	134	75	0.74	10.5
SM15T82AY/CAY	0.2	1	70	77.8	82	86	1	113	13.9	1.94	146	69	0.87	10.5

1. To calculate V_{BR} versus T_j : V_{BR} at $T_j = V_{BR}$ at $25\text{ }^{\circ}\text{C} \times (1 + \alpha T \times (T_j - 25))$
2. To calculate V_{CL} versus T_j : V_{CL} at $T_j = V_{CL}$ at $25\text{ }^{\circ}\text{C} \times (1 + \alpha T \times (T_j - 25))$
3. To calculate V_{CL} max versus $I_{PPappli}$: $V_{CLmax} = V_{BR}$ max + $R_D \times I_{PPappli}$
4. Surge capability given for both directions for unidirectional and bidirectional devices

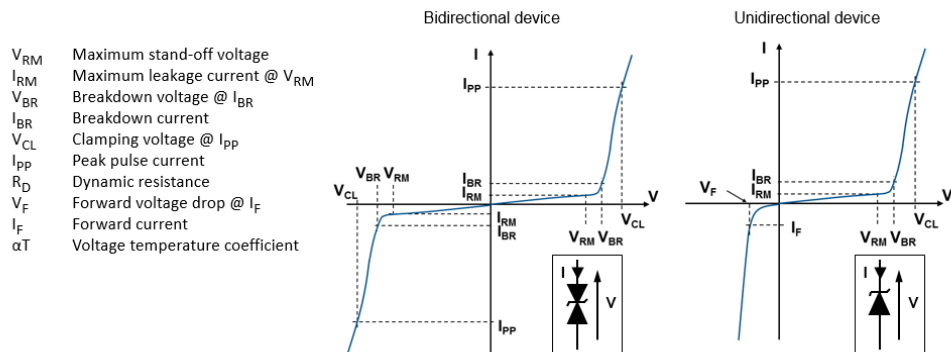
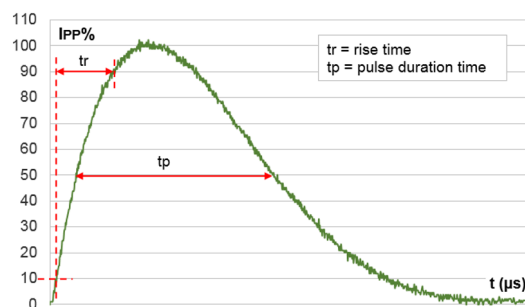
1.1 Characteristics (curves)

Figure 3. Maximum peak power dissipation versus initial junction temperature

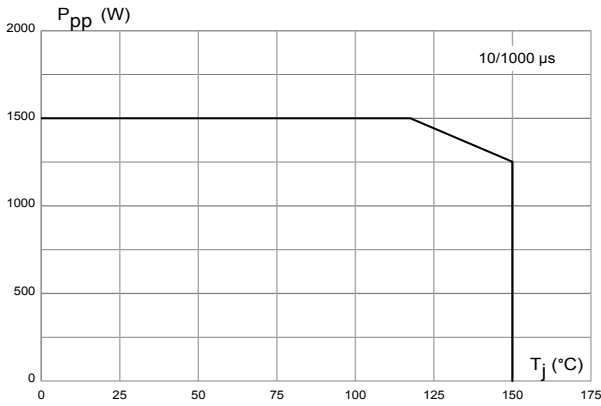

Figure 4. Maximum peak pulse power versus exponential pulse duration

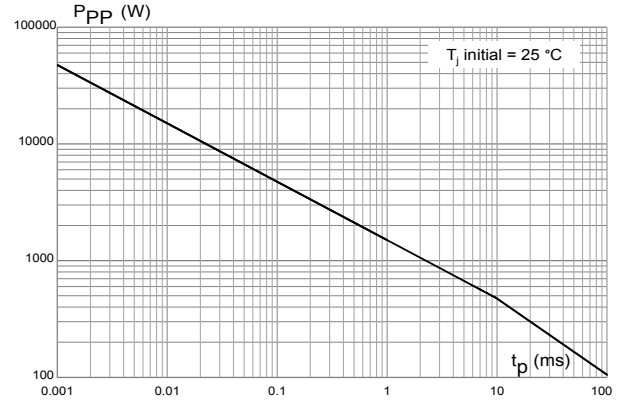

Figure 5. Maximum peak pulse current versus clamping voltage

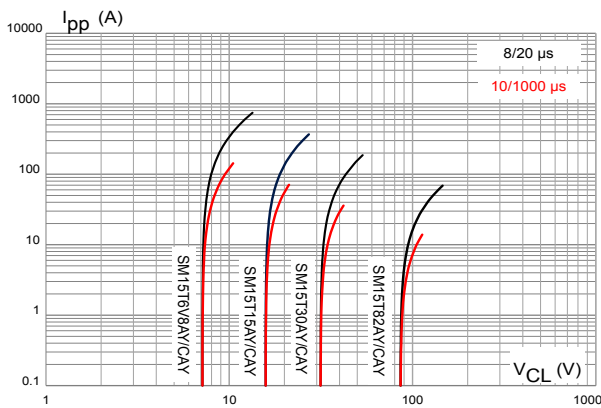

Figure 6. Dynamic resistance versus pulse duration

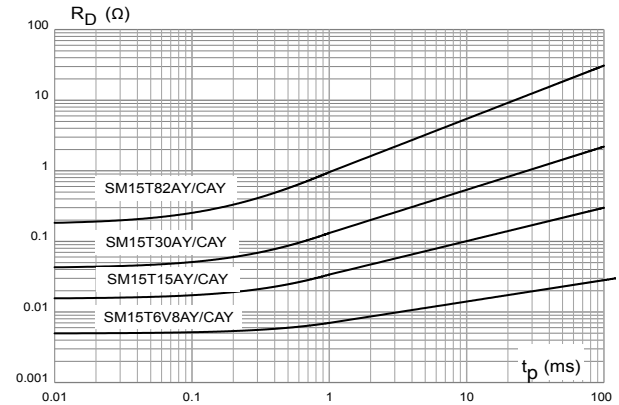

Figure 7. Junction capacitance versus reverse applied voltage (unidirectional type)

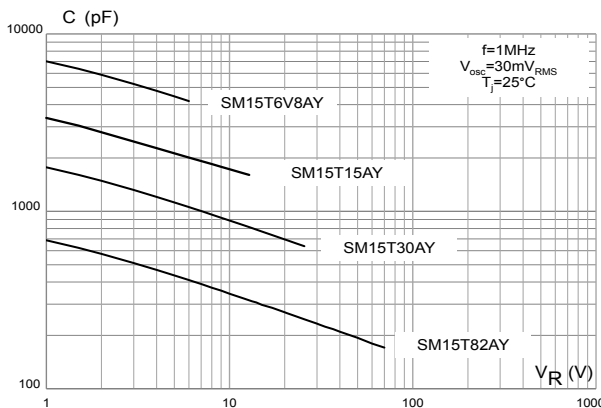

Figure 8. Junction capacitance versus applied voltage (bidirectional type)

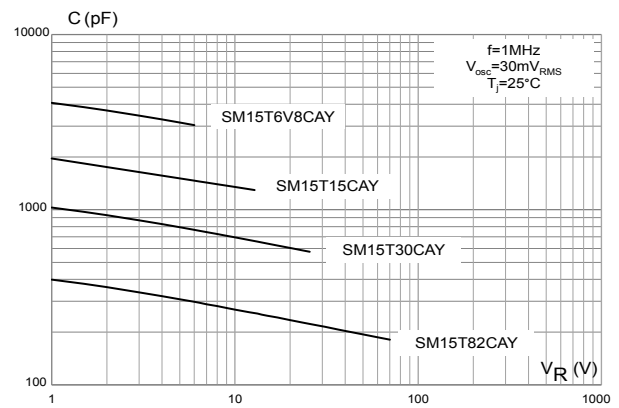

Figure 9. Leakage current versus junction temperature

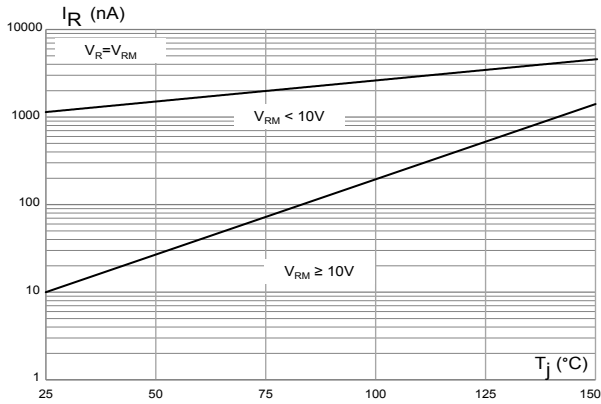

Figure 10. Peak forward voltage drop versus peak forward current

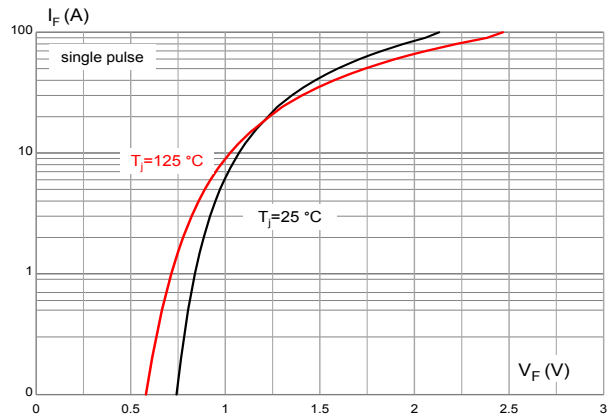

Figure 11. Thermal impedance junction to ambient versus pulse duration

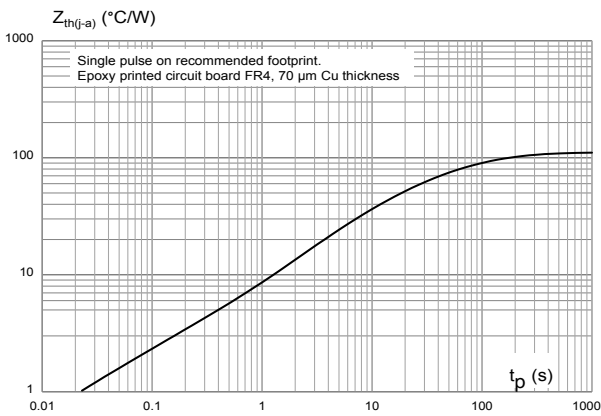

Figure 12. Thermal resistance junction to ambient versus copper area under each lead

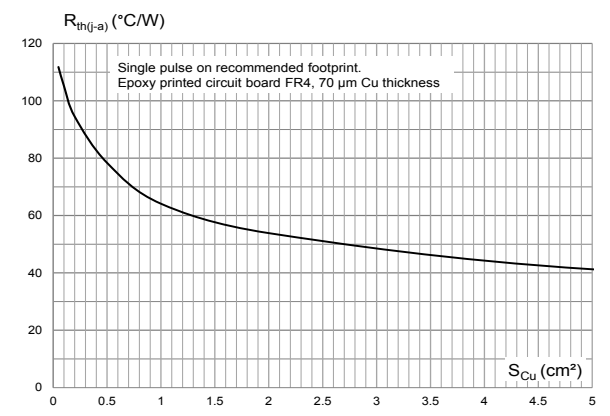

Figure 13. ISO7637-2 pulse 1: Vs = -150 V with 12 V battery

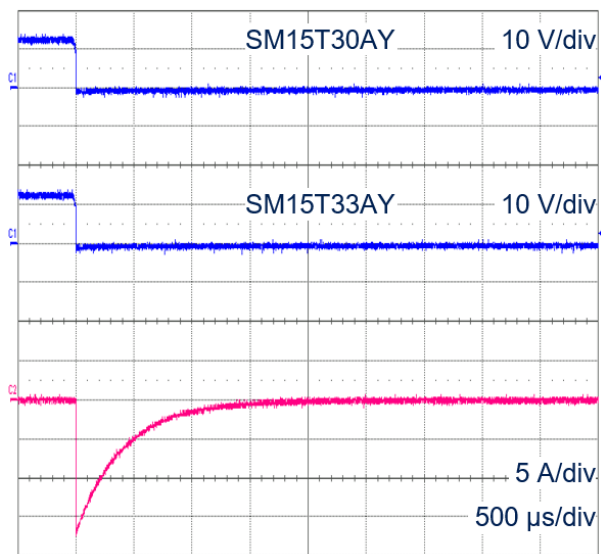

Figure 14. ISO7637-2 pulse 2a: Vs = +112 V with 12 V battery

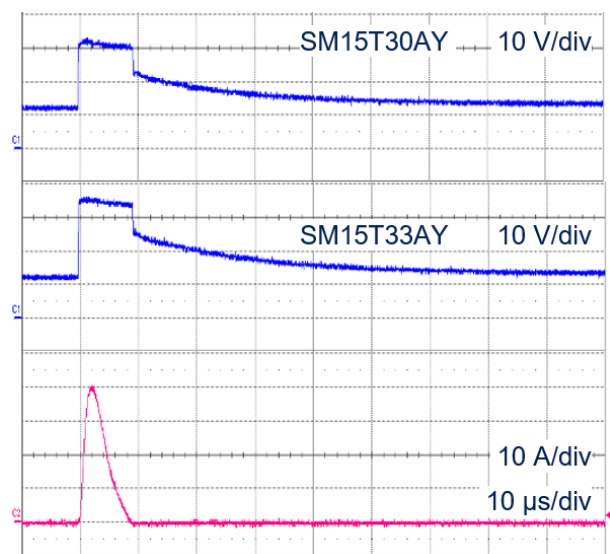
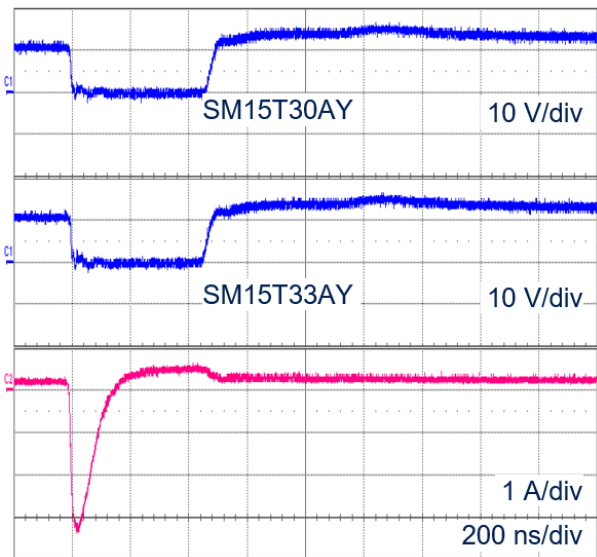
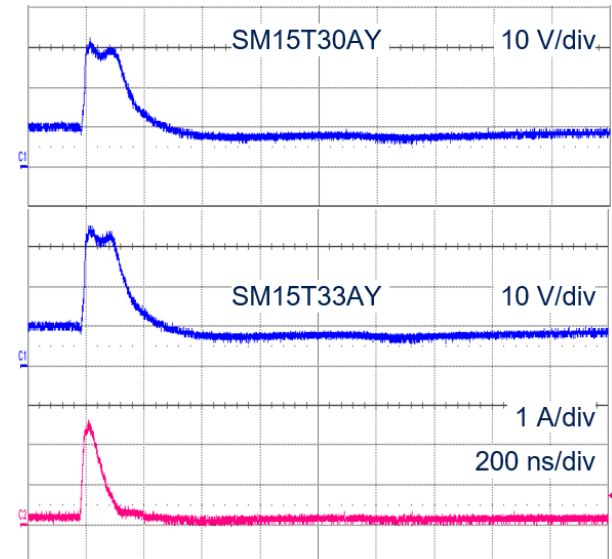

Figure 15. ISO7637-2 pulse 3a: $V_s = -220\text{ V}$ with 12 V battery

Figure 16. ISO7637-2 pulse 3b: $V_s = +150\text{ V}$ with 12 V battery

2 Package information

In order to meet environmental requirements, ST offers these devices in different grades of **ECOPACK** packages, depending on their level of environmental compliance. ECOPACK specifications, grade definitions and product status are available at: www.st.com. ECOPACK is an ST trademark.

2.1 SMC package information

- Epoxy meets UL94, V0

Figure 17. SMC package outline

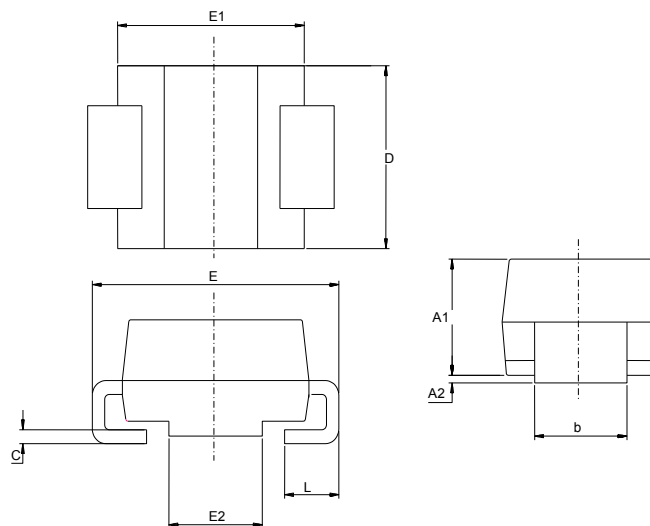

Table 3. SMC package mechanical data

Ref.	Dimensions			
	Millimeters		Inches (for reference only)	
	Min.	Max.	Min.	Max.
A1	1.90	2.45	0.075	0.096
A2	0.05	0.20	0.002	0.008
b	2.90	3.20	0.114	0.126
c	0.15	0.40	0.006	0.016
D	5.55	6.25	0.218	0.246
E	7.75	8.15	0.305	0.321
E1	6.60	7.15	0.260	0.281
E2	4.40	4.70	0.173	0.185
L	0.75	1.50	0.030	0.060

Figure 18. Footprint recommendation

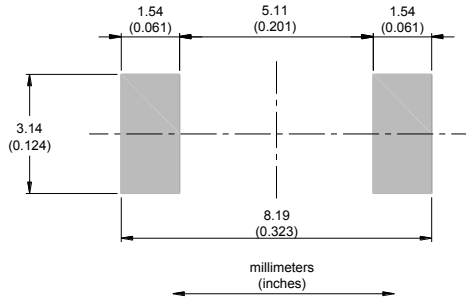

Figure 19. Marking layout

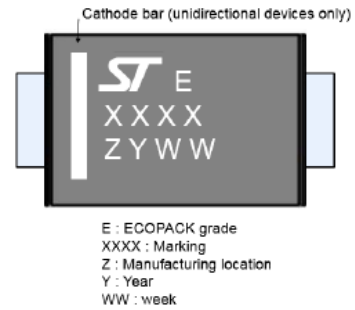
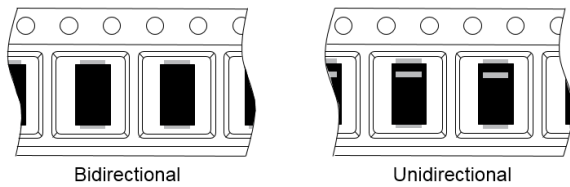

Figure 20. Package orientation in reel



Taped according to EIA-481
Pocket dimensions are not on scale.
Pocket shape may vary depending on package
On bidirectional devices, marking and logo may not be always in the same direction.

Figure 21. Tape and reel orientation

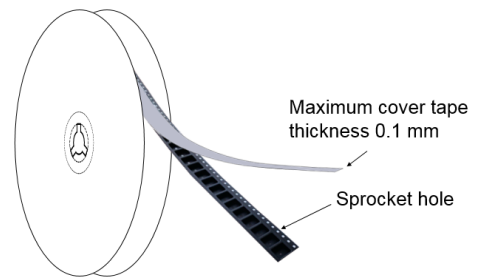

Figure 22. 13" reel dimension values (mm)

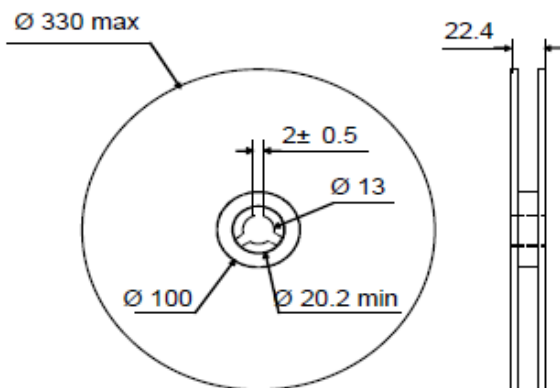

Figure 23. Inner box dimension values (mm)

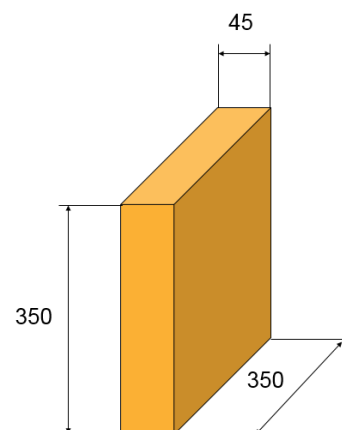
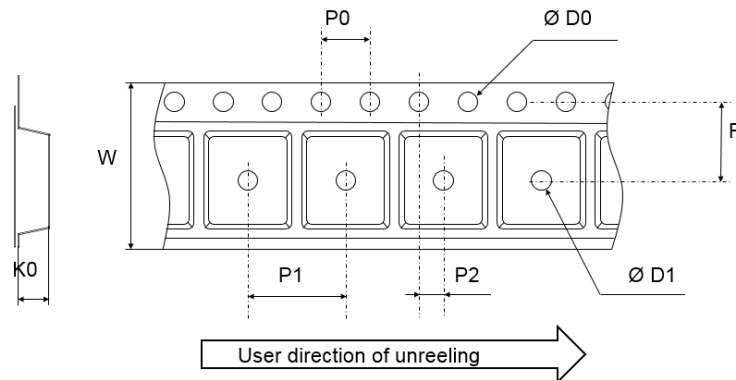

Figure 24. Tape outline



Note: Pocket dimensions are not on scale
Pocket shape may vary depending on package

Table 4. Tape dimension values

Ref.	Dimensions		
	Millimeters		
	Min.	Typ.	Max.
D0	1.4	1.5	1.6
D1	1.5		
F	7.4	7.5	7.6
K0	2.39	2.49	2.59
P0	3.9	4.0	4.1
P1	7.9	8.0	8.1
P2	1.9	2.0	2.1
W	15.7	16	16.3

2.2 Reflow profile

Figure 25. ST ECOPACK recommended soldering reflow profile for PCB mounting

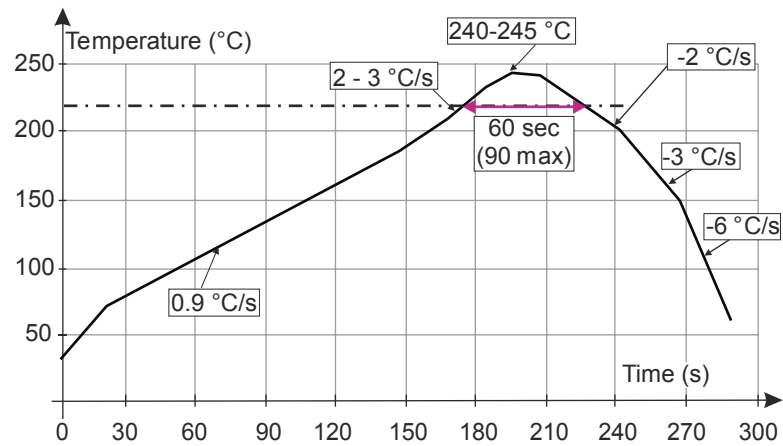

Note: Minimize air convection currents in the reflow oven to avoid component movement. Maximum soldering profile corresponds to the latest IPC/JEDEC J-STD-020.

3 Application and design guidelines

More information is available in the application note AN2689 “Protection of automotive electronics from electrical hazards, guidelines for design and component selection”.

4 Ordering information

Figure 26. Ordering information scheme

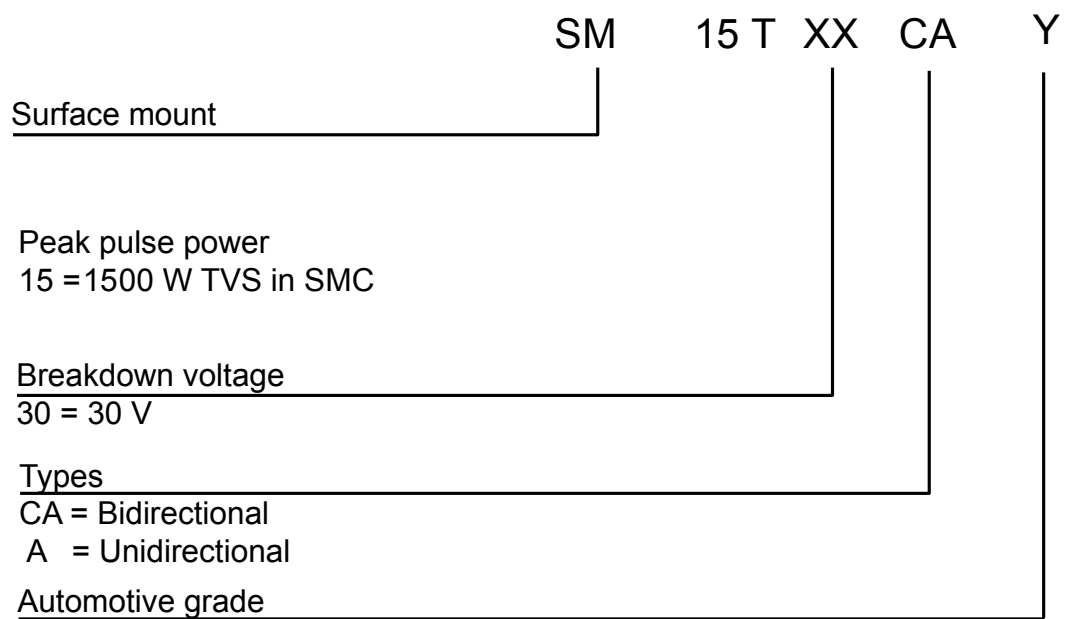

Table 5. Ordering information

Order code	Marking	Package	Weight	Base qty.	Delivery mode
SM15TxxxAY / CAY	See Table 6. Marking	SMC	0.25 g	2500	Tape and reel

Table 6. Marking

Order code	Marking	Order code	Marking
SM15T6V8AY	MDEY	SM15T6V8CAY	BDEY
SM15T7V5AY	MDGY	SM15T7V5CAY	BDGY
SM15T10AY	MDPY	SM15T10CAY	BDPY
SM15T12AY	MDTY	SM15T12CAY	BDTY
SM15T15AY	MDXY	SM15T15CAY	BDXY
SM15T18AY	MEEY	SM15T18CAY	BEEY
SM15T22AY	MEKY	SM15T22CAY	BEKY
SM15T24AY	MEMY	SM15T24CAY	BEMY
SM15T27AY	MEPY	SM15T27CAY	BEPY
SM15T30AY	MERY	SM15T30CAY	BERY
SM15T33AY	METY	SM15T33CAY	BETY
SM15T36AY	MEVY	SM15T36CAY	BEVY
SM15T39AY	MEXY	SM15T39CAY	BEXY
SM15T47AY	MFAY	SM15T47CAY	BFAY
SM15T56AY	MFBY	SM15T56CAY	BFBY
SM15T68AY	MFPY	SM15T68CAY	BFPY
SM15T75AY	MFOY	SM15T75CAY	BFOY
SM15T82AY	MFRY	SM15T82CAY	BFRY

Revision history

Table 7. Document revision history

Date	Revision	Changes
15-Sep-2010	1	Initial release.
18-Oct-2011	2	Deleted old Table 2. Thermal parameter. Updated Table 2 and added order codes in Table 4. Updated Figure 5, Figure 10 and Figure 11. Updated Complies with the following standards on page 1.
27-Mar-2012	3	Added footnote on page 1.
06-Oct-2021	4	Updated Section 1.1 Characteristics (curves) . Minor text changes.
08-Oct-2021	5	Updated SM15T18AY product link.

IMPORTANT NOTICE – PLEASE READ CAREFULLY

STMicroelectronics NV and its subsidiaries (“ST”) reserve the right to make changes, corrections, enhancements, modifications, and improvements to ST products and/or to this document at any time without notice. Purchasers should obtain the latest relevant information on ST products before placing orders. ST products are sold pursuant to ST’s terms and conditions of sale in place at the time of order acknowledgement.

Purchasers are solely responsible for the choice, selection, and use of ST products and ST assumes no liability for application assistance or the design of Purchasers’ products.

No license, express or implied, to any intellectual property right is granted by ST herein.

Resale of ST products with provisions different from the information set forth herein shall void any warranty granted by ST for such product.

ST and the ST logo are trademarks of ST. For additional information about ST trademarks, please refer to www.st.com/trademarks. All other product or service names are the property of their respective owners.

Information in this document supersedes and replaces information previously supplied in any prior versions of this document.

© 2021 STMicroelectronics – All rights reserved