

0.4mm Pitch  
Board to Board Connector

# 5846 Series

シリーズ (Series)	5846
基板間高さ (Stacking Height)	3.0mm
極間隔 (Pitch)	0.4mm
極数 (No. of Positions)	20 to 80 Pos.
定格電流 (Rated Current)	DC 0.4A/Contact
定格電圧 (Rated Voltage)	DC 50V/Contact
耐電圧 (D. W. Voltage)	AC 250Vrms/min.
コンタクト材質 (Contact Material)	銅合金 (Copper alloy)
インシュレータ材質 (Insulator Material)	耐熱樹脂 (Heat-resistant plastic)
使用温度範囲 (Operating Temperature)	-40 to +85°C

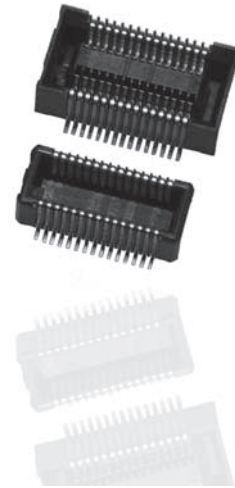

#### ◆概要

5846 シリーズは、ノートパソコン等にお使いいただける0.4mmピッチの基板対基板コネクタです。基板間高さ3.0mm、端子を含めた幅寸法は5.8mmです。

#### ◆特長

- (1) コネクタ裏面は底壁が形成されておりコンタクトの露出がないため、基板配線との短絡もなく配線設計を自由に行うことができます。
- (2) 高い接触信頼性を実現するために、接触構造は振動や落下衝撃に強い挟み込み構造を採用するとともに、接触部は飛散したフラックスや付着した異物を排除する独自接点構造を採用しました。
- (3) 優れたクリック感で嵌合力は低く、高い嵌合保持力を実現しました。
- (4) 実装工程で使いいただけるチェッカー専用コネクタもご用意しました。
- (5) 1,000 個入りのエンボステープ梱包でお届けします。
- (6) 環境に優しい RoHS 指令対応品です。

#### ◆Outline

The 5846 Series are 0.4mm pitch, ideal for notePCs etc. These products have achieved a stacking height of 3.0mm and a width of 5.8mm including leads.

#### ◆Features

- (1) As there is a bottom surface on the back of the connector and the contact part is not exposed, wiring patterns can be flexibly laid out on the substrate area which is positioned between the terminals. Suitable for high density mounting.
- (2) In order to obtain high contact reliability, a pinching structure, which is highly resistant to vibrations and drop shocks, is adopted for the contact structure. In addition, an original structure in the contact points eliminates foreign matters such as scattered flux.
- (3) An original structure has secure "click" feeling, low mating force and high retention force.
- (4) A checker (inspection jig) connector is also available for carrying out easy checks on conductivity and short circuits in connectors under mated conditions.
- (5) Packaged in tape and reel: 1,000 pieces/reel.
- (6) RoHS compliant product.

本カタログには推奨めっきを掲載しております。めっき種類・仕様、ならびに生産対応可能極数については営業部にご確認願います。Recommended plating types are mentioned in this catalogue. For other plating types and their specifications, and available numbers of positions, please feel free to contact our sales department.

# 0.4mm Pitch 5846 Series

0.4mm ピッチ 嵌合高さ 3.0mm 金具無し SMT  
 0.4mm Pitch, Stacking Height=3.0mm, Without Metal tab, SMT

## ● Plug

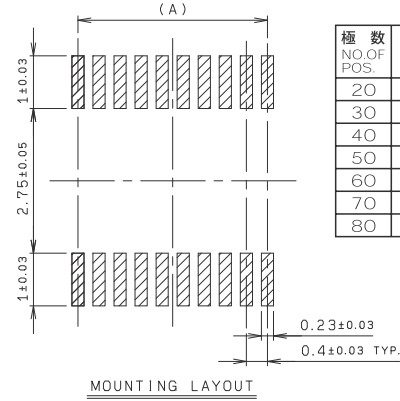
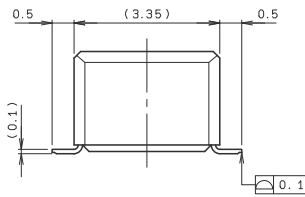
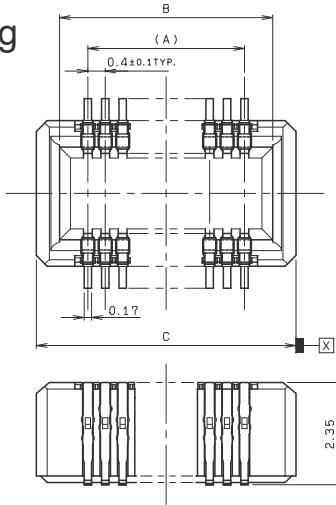

極数 NO. OF POS.	A	B	C
20	3.6	4.9	5.97
30	5.6	6.9	7.97
40	7.6	8.9	9.97
50	9.6	10.9	11.97
60	11.6	12.9	13.97
70	13.6	14.9	15.97
80	15.6	16.9	17.97

## ● Receptacle

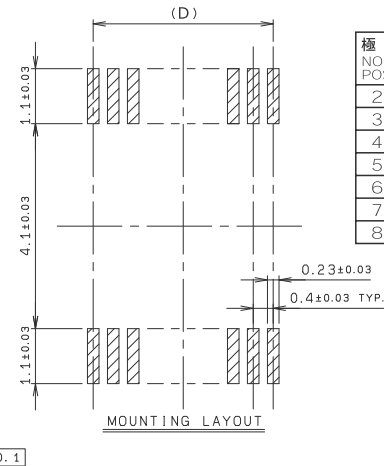
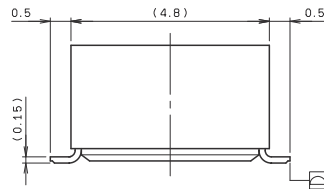
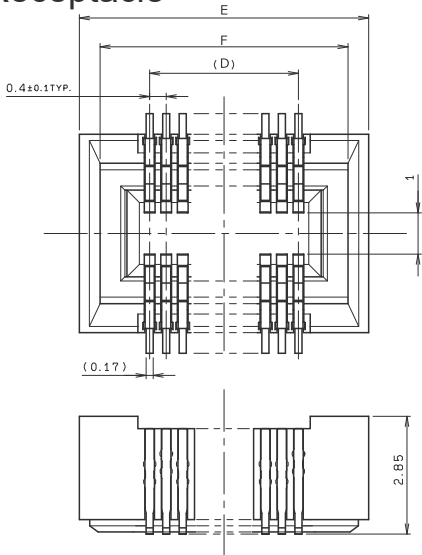

極数 NO. OF POS.	D	E	F
20	3.6	7.0	6.0
30	5.6	9.0	8.0
40	7.6	11.0	10.0
50	9.6	13.0	12.0
60	11.6	15.0	14.0
70	13.6	17.0	16.0
80	15.6	19.0	18.0

## ● Packaging

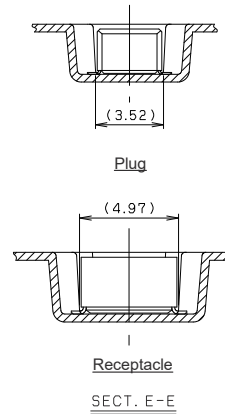
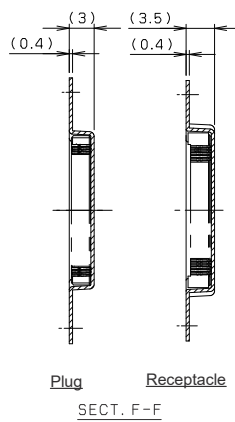
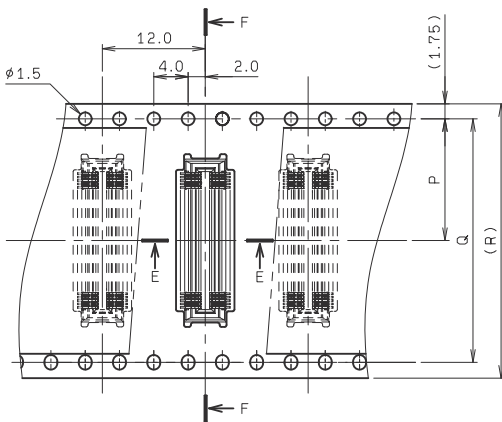

極数 NO. OF POS.	P	Q	R
20	7.5	—	16
30	7.5	—	16
40	11.5	—	24
50	11.5	—	24
60	11.5	—	24
70	11.5	—	24
80	14.2	28.4	32

### 注文コード/Ordering Code

Plug  
 Part No. **14 5846 0XX 000 829+**  
 極数 No. of Pos.

Receptacle  
 Part No. **24 5846 0XX 000 829+**  
 極数 No. of Pos.

RoHS 対応品  
 RoHS Compliant Product

梱包数量: 1,000 個/リール  
 PACKING QUANTITY: 1,000/Reel

本カタログには推奨めっきを掲載しております。めっき種類・仕様、ならびに生産対応可能極数については営業部にご確認願います。  
 Recommended plating types are mentioned in this catalogue. For other plating types and their specifications, and available numbers of positions, please feel free to contact our sales department.