

6MHz Synchronous Rectification Buck-Boost DC/DC Converter IC

The MB39C326 is a high efficiency, low noise synchronous, Buck-boost DC/DC converter designed for powering the radio frequency power amplifiers (RFPA) in 3G/GSM mobile handsets and other mobile applications.

Features

- High efficiency : Up to 93%
- Input voltage range : 2.5V to 5.5V
- Adjustable output voltage range : 0.8V to 5.0V
- Maximum output current (Buck, PWM mode) : 1200 mA ($V_{IN} = 5.0V$ to $5.5V$, at $V_o=5.0V$)
: 1200 mA ($V_{IN} = 3.6V$ to $5.5V$, at $V_o=3.6V$)
: 1200 mA ($V_{IN} = 3.3V$ to $5.5V$, at $V_o=3.3V$)
- (Boost, PWM mode) : 900 mA ($V_{IN} = 3.7V$ to $5.0V$, at $V_o=5.0V$)
: 700 mA ($V_{IN} = 2.5V$ to $3.6V$, at $V_o=3.6V$)
: 800 mA ($V_{IN} = 2.5V$ to $3.3V$, at $V_o=3.3V$)
- (Buck, Power save mode, ILIMSEL=H) : 600 mA ($V_{IN} = 5.0V$ to $5.5V$, at $V_o=5.0V$)
: 600 mA ($V_{IN} = 3.6V$ to $5.5V$, at $V_o=3.6V$)
: 600 mA ($V_{IN} = 3.3V$ to $5.5V$, at $V_o=3.3V$)
- (Boost, Power save mode, ILIMSEL=H) : 500 mA ($V_{IN} = 3.7V$ to $5.0V$, at $V_o=5.0V$)
: 400 mA ($V_{IN} = 2.5V$ to $3.6V$, at $V_o=3.6V$)
: 500 mA ($V_{IN} = 2.5V$ to $3.3V$, at $V_o=3.3V$)
- Quiescent current : 50 μA
- 6 MHz PWM operation allows 0.5 μH small form inductor
- Automatic Transition between Buck mode and boost mode
- Power save Mode for improved efficiency at light load current
- Selectable output voltage with external resistor
- Built-in Over temperature protection circuit
- Built-in Under voltage lockout protection circuit
- Package: WL-CSP (20pin 0.4 mm-ball-pitch 2.15 × 1.94 mm)

Note: This product supports the web-based design simulation tool, Easy DesignSim. It can easily select external components and can display useful information. Please access from <http://cypress.transim.com/login.aspx>

Applications

- Products that use 1-cell lithium batteries for the power supply
- RF power amplifier
- Cell-phone
- RF-PC card and PDA

Contents

1. Pin Assignments	3
2. Pin Descriptions	3
3. Block Diagram.....	4
4. Function.....	4
5. Absolute Maximum Ratings.....	6
6. Recommended Operating Conditions.....	6
7. Electrical Characteristics	8
8. Typical Applications Circuit (RF Power Amplifier).....	8
9. Application Notes	9
10. Inductor Selection.....	11
11. Input Capacitor Selection.....	11
12. Output Capacitor Selection.....	11
13. Thermal Information	11
14. Notes on Board Layout	12
15. Example of Standard Operation Characteristics.....	13
16. Usage Precaution	16
17. Notes on Mounting	16
18. Ordering Information	17
19. EV Board Ordering Information	17
20. RoHS Compliance Information of Lead (Pb) Free Version	18
21. Marking	18
22. Labeling Sample	19
23. MB39C326PW Recommended Conditions of Moisture Sensitivity Level	22
24. Package Dimensions	23
25. Major Changes	24
Document History	24

1. Pin Assignments

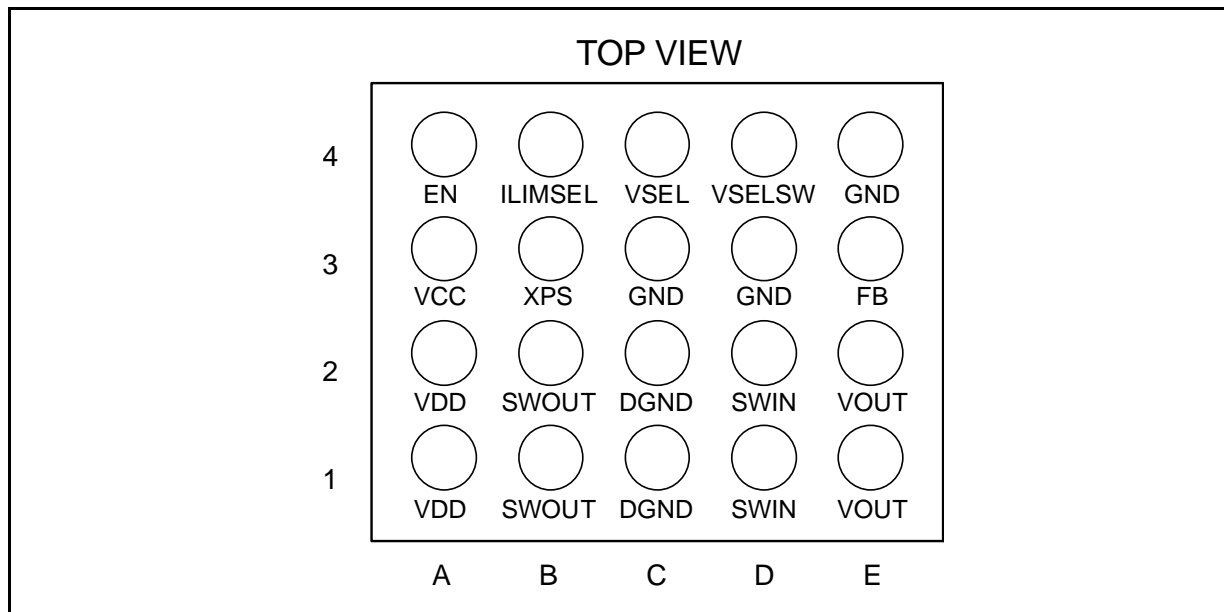

2. Pin Descriptions

Pin No.	Pin Name	I/O	Description
A4	EN	I	IC Enable input pin (H: Enable, L: Shutdown)
E3	FB	I	Voltage feedback pin
C3, D3, E4	GND		Control / Logic ground pins
B4	ILIMSEL	I	Inductor peak current limit pin
B1, B2	SWOUT	I	Connection pins for Inductor
D1, D2	SWIN	I	Connection pins for Inductor
C1, C2	DGND		Power ground pins
C4	VSEL	I	Output voltage select pin (H: Using R3 L: No using R3)
D4	VSELSW		Connection pin for output voltage setting resistor R3
A1, A2	VDD	I	Electric power input pin for DCDC converter output voltage
A3	VCC	I	Electric power input pin for IC control block
B3	XPS	I	Power save mode pin (H: PWM mode, L: Power save mode)
E1, E2	VOUT	O	Buck-boost converter output pins

3. Block Diagram

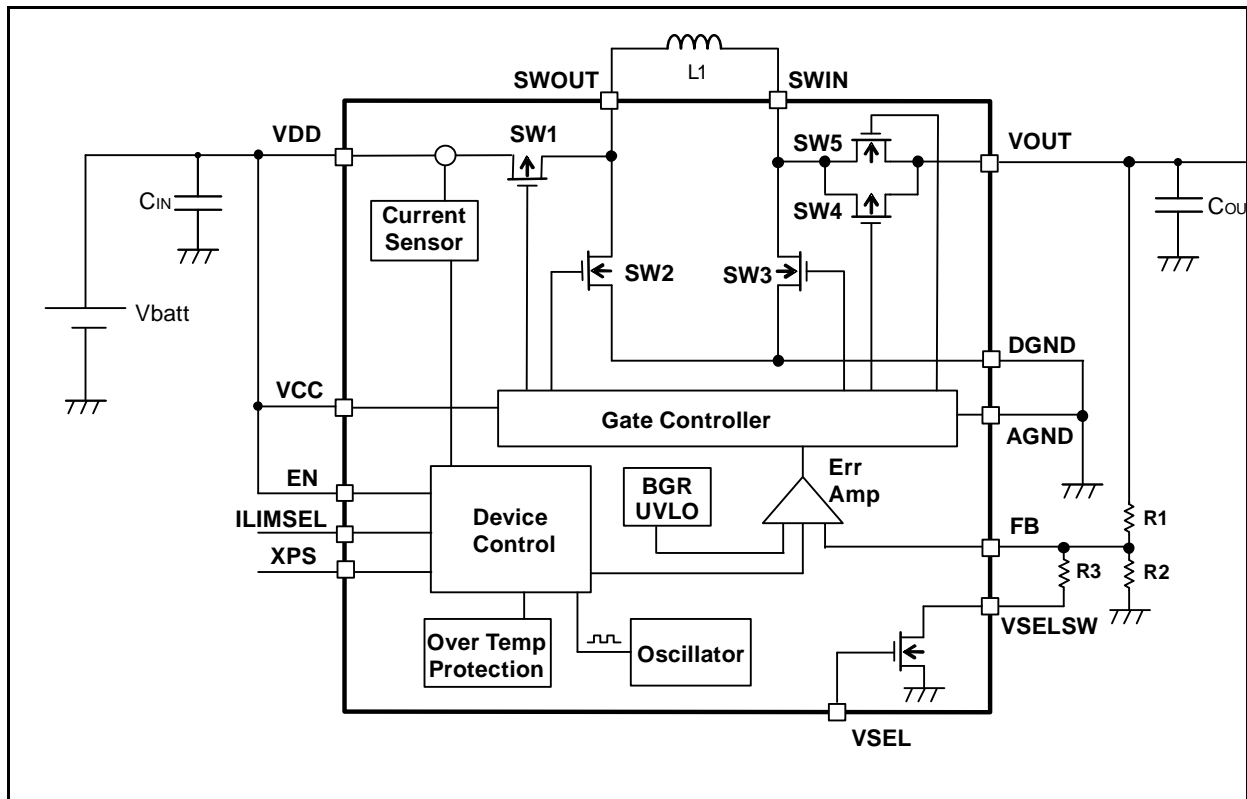

4. Function

(1) Gate Controller

It is controlled the synchronous rectification operation of built-in 2-P-ch MOS FETs and 2-N-ch MOS FETs according to frequency (6 MHz) set with a oscillator at the normal operation.

(2) Error Amp & phase compensation circuit

This compares the feedback voltage and the reference voltage (VREF). This IC contains the phase compensation circuit which optimizes the IC operation. Therefore, it is unnecessary to consideration of the phase compensation circuit, and external parts for the phase compensation.

(3) Band gap reference circuit

A high accuracy reference voltage is generated with BGR (band gap reference) circuit.

(4) Oscillator

The internal oscillator output a 6 MHz clock signal to set a switching frequency.

(5) Over temperature protection circuit

The over temperature protection circuit is built-in as a protection circuit. When junction temperature reaches +125°C, the over temperature protection circuit turns off all N-ch MOS FETs and P-ch MOS FETs. Also, when the junction temperature falls to +110°C, this IC operates normally.

(6) Inductor peak current limit circuit (Current Sensor + Device Control)

The inductor peak current limit circuit detects the current (I_{LX}) which flows from built-in P-ch MOS FET connected to VDD into an external inductor and limits the inductor peak current (I_{PK}).

(7) Power save mode operation

Power save mode is used to improve efficiency at the light load. By setting the XPS pin to "L" level, power save mode is set and the operation is performed in PWM mode or PFM mode depending on the load current. At this time, if the load current is low, this IC operates with PFM (PulseFrequency Modulation). It should be used above $V_{OUT} = 0.8V$. If the output voltage becomes lower than the setting value at the light load, switching is performed several times and the output voltage rises. If the output voltage reaches the setting value, it changes to the stop state, all of the four FETs are turned off, and the switching loss and the dissipation power for the circuit are suppressed.

Consumption current in stop state at the power save mode becomes about 50μA.

■ Function Table

Mode	XPS	ILIMSEL	Input Voltage Range[V]		Output Voltage Range[V]		Inductor peak Current Limit (I_{PK}) [A]
			Min	Max	Min	Max	
PWM mode	H	L	2.5	5.5	0.8	5.0	3.1
Power save mode	L	H					1.3
		L					0.49

Note: Input of (XPS, ILIMSEL = H, H) is prohibited.

(8) EN pin

When the EN pin is set to "H" level, the device operation is enabled. When the EN pin is set to GND, the device is switched to shutdown mode.

When the EN pin is set to "L" level, the device is switched to shutdown mode.

In shutdown mode, the regulator stops switching, all FET switches are turned off, and the load is disconnected from the input.

(9) VSEL pin

MB39C326 has a function to change the output voltage with the VSEL pin and additional resistance.

For details of the output voltage settings, see the section 2. of "Programming the Output Voltage" in 9. Application .

(10) Buck-Boost operations

MB39C326 operates in Buck or Boost mode by monitoring the VCC/VOUT voltage with a newly developed PWM controller.

The transition between buck and boost mode is smooth and the efficiency is high.

During Buck mode ($VCC > VOUT$), SW1 and SW2 perform switching while SW3 is fixed to OFF and SW4 and 5 are fixed to ON.

During Boost mode ($VCC < VOUT$), SW3, SW4 and SW5 perform switching while SW1 is fixed to ON and SW2 is fixed to OFF.

The voltage values of VCC and VDD at the switching between buck and boost vary depending on the load current, the environmental temperature and the process variations.

(11) Startup circuit

MB39C326 has the soft-start function to prevent rush current upon turning on of the power.

The startup time is approximately 100 μ seconds.

5. Absolute Maximum Ratings

Parameter	Symbol	Condition	Rating		Unit
			Min	Max	
Power supply voltage	V _{MAX}	VDD, VCC	-0.3	+7.0	V
Signal input voltage	V _{INMAX}	EN, XPS, VSEL, ILIMSEL	-0.3	V _{DD} + 0.3	V
Power dissipation	P _D	T _a ≤ +25°C	-	1080	mW
Storage temperature	T _{STG}	-	-65	+150	°C
ESD Voltage	V _{ESDH}	Human Body Model (100 pF, 1.5 kΩ)	-2000	+2000	V
	V _{ESDM}	Machine Model (200 pF, 0Ω)	-200	+200	V
	V _{ESDC}	Charged device model	-1000	+1000	V
Maximum junction temperature	T _{J-MAX}	-	-	+95	°C

WARNING:

Semiconductor devices may be permanently damaged by application of stress (including, without limitation, voltage, current or temperature) in excess of absolute maximum ratings. Do not exceed any of these ratings.

6. Recommended Operating Conditions

Parameter	Symbol	Condition	Value			Unit
			Min	Typ	Max	
Power supply voltage	V _{DD}	VDD, VCC	2.5(*1)	3.7	5.5(*1)	V
Signal input voltage	V _{IDD}	EN, XPS, VSEL, ILIMSEL	0.0	-	VDD	V
Output current (Buck) PWM mode	I _o (Max1)	V _{IN} = 5.5, V _o = 5.0V, XPS = H, ILIMSEL = L	-	-	1200	mA
		V _{IN} = 5.5, V _o = 4.4V, XPS = H, ILIMSEL = L	-	-	1200	mA
		V _{IN} = 5.5, V _o = 3.6V, XPS = H, ILIMSEL = L	-	-	1200	mA
	I _o (Max2)	V _{IN} = 4.2, V _o = 3.6V, XPS = H, ILIMSEL = L	-	-	1200	mA
		V _{IN} = 5.5, V _o = 3.3V, XPS = H, ILIMSEL = L	-	-	1200	mA
		V _{IN} = 3.7, V _o = 3.3V, XPS = H, ILIMSEL = L	-	-	1200	mA
	I _o (Max3)	V _{IN} = 5.5, V _o = 2.0V, XPS = H, ILIMSEL = L	-	-	1200	mA
		V _{IN} = 3.7, V _o = 2.0V, XPS = H, ILIMSEL = L	-	-	1200	mA
		V _{IN} = 2.5, V _o = 2.0V, XPS = H, ILIMSEL = L	-	-	1200	mA
	I _o (Max4)	V _{IN} = 5.5, V _o = 1.2V, XPS = H, ILIMSEL = L	-	-	700	mA
		V _{IN} = 3.7, V _o = 1.2V, XPS = H, ILIMSEL = L	-	-	600	mA
		V _{IN} = 2.5, V _o = 1.2V, XPS = H, ILIMSEL = L	-	-	600	mA
	I _o (Max5)	V _{IN} = 5.5, V _o = 0.8V, XPS = H, ILIMSEL = L	-	-	600	mA
		V _{IN} = 3.7, V _o = 0.8V, XPS = H, ILIMSEL = L	-	-	500	mA
		V _{IN} = 2.5, V _o = 0.8V, XPS = H, ILIMSEL = L	-	-	250	mA
Output current (Boost) PWM mode	I _o (Max6)	V _{IN} = 2.5V, V _o = 3.3V, XPS = H, ILIMSEL = L	-	-	800	mA
		V _{IN} = 2.5V, V _o = 3.6V, XPS = H, ILIMSEL = L	-	-	700	mA
	I _o (Max7)	V _{IN} = 3.7V, V _o = 4.4V, XPS = H, ILIMSEL = L	-	-	1000	mA
		V _{IN} = 2.5V, V _o = 4.4V, XPS = H, ILIMSEL = L	-	-	700	mA
	I _o (Max8)	V _{IN} = 3.7V, V _o = 5V, XPS = H, ILIMSEL = L	-	-	900	mA
V _{IN} = 2.5V, V _o = 5V, XPS = H, ILIMSEL = L		-	-	600	mA	
Output current (Buck) Power save mode, ILIMSEL=H	I _o (Max9)	V _{IN} = 5.5, V _o = 5.0V, XPS = L, ILIMSEL = H	-	-	600	mA
		V _{IN} = 5.5, V _o = 4.4V, XPS = L, ILIMSEL = H	-	-	600	mA
	I _o (Max10)	V _{IN} = 5.5, V _o = 3.6V, XPS = L, ILIMSEL = H	-	-	600	mA
		V _{IN} = 4.2, V _o = 3.6V, XPS = L, ILIMSEL = H	-	-	600	mA
	I _o (Max11)	V _{IN} = 5.5, V _o = 3.3V, XPS = L, ILIMSEL = H	-	-	600	mA
		V _{IN} = 3.7, V _o = 3.3V, XPS = L, ILIMSEL = H	-	-	600	mA

Parameter	Symbol	Condition	Value			Unit
			Min	Typ	Max	
	Io (Max16)	V _{IN} = 5.5, Vo = 2.0V, XPS = L, ILIMSEL = H	-	-	600	mA
		V _{IN} = 3.7, Vo = 2.0V, XPS = L, ILIMSEL = H	-	-	500	mA
		V _{IN} = 2.5, Vo = 2.0V, XPS = L, ILIMSEL = H	-	-	500	mA
	Io (Max17)	V _{IN} = 5.5, Vo = 1.2V, XPS = L, ILIMSEL = H	-	-	400	mA
		V _{IN} = 3.7, Vo = 1.2V, XPS = L, ILIMSEL = H	-	-	300	mA
		V _{IN} = 2.5, Vo = 1.2V, XPS = L, ILIMSEL = H	-	-	300	mA
	Io (Max18)	V _{IN} = 5.5, Vo = 0.8V, XPS = L, ILIMSEL = H	-	-	400	mA
		V _{IN} = 3.7, Vo = 0.8V, XPS = L, ILIMSEL = H	-	-	200	mA
		V _{IN} = 2.5, Vo = 0.8V, XPS = L, ILIMSEL = H	-	-	200	mA
Output current (Boost) Power save mode, ILIMSEL=H	Io (Max19)	V _{IN} = 2.5V, Vo = 3.3V, XPS = L, ILIMSEL = H	-	-	500	mA
	Io (Max20)	V _{IN} = 2.5V, Vo = 3.6V, XPS = L, ILIMSEL = H	-	-	400	mA
	Io (Max21)	V _{IN} = 3.7V, Vo = 4.4V, XPS = L, ILIMSEL = H	-	-	600	mA
		V _{IN} = 2.5V, Vo = 4.4V, XPS = L, ILIMSEL = H	-	-	350	mA
	Io (Max22)	V _{IN} = 3.7V, Vo = 5V, XPS = L, ILIMSEL = H	-	-	500	mA
		V _{IN} = 2.5V, Vo = 5V, XPS = L, ILIMSEL = H	-	-	300	mA
Output current (Buck) Power save mode, ILIMSEL=L	Io (Max23)	V _{IN} = 3.7, Vo = 3.3V, XPS = L, ILIMSEL = L	-	-	160	mA
Output current (Boost) Power save mode, ILIMSEL=L	Io (Max24)	V _{IN} = 2.5, Vo = 5V, XPS = L, ILIMSEL = L	-	-	60	mA
Operating Ambient temperature	Ta	-	-40	-	+85	°C
Junction temperature range	Tj	-	-40	-	+95	°C
Inductor value	L	-	-	0.5	-	μH
Feedback resistor value	R1	-	-	620	-	kΩ

*1: Depending on the setting condition. See "■Function Table" in "4. Function (7) Power save mode operation".

WARNING:

1. The recommended operating conditions are required in order to ensure the normal operation of the semiconductor device. All of the device's electrical characteristics are warranted when the device is operated under these conditions.
2. Any use of semiconductor devices will be under their recommended operating condition.
3. Operation under any conditions other than these conditions may adversely affect reliability of device and could result in device failure.
4. No warranty is made with respect to any use, operating conditions or combinations not represented on this data sheet. If you are considering application under any conditions other than listed herein, please contact sales representatives beforehand.

7. Electrical Characteristics

The specifications apply under the recommended operating condition.

Parameter	Symbol	Condition	Value			Unit	
			Min	Typ	Max		
Output voltage range	V_O	-	0.8	-	5.0	V	
Feedback voltage	V_{FB}	-	490	500	510	mV	
Line Regulation	V_{LINE}	IO = 0 to 800 mA	-	0.2	-	%	
Load Regulation	V_{LOAD}	IO = 0 to 800 mA	-	0.3	-	%	
Inductor peak current limit	I_{PK}	XPS = H, ILIMSEL = L	2.50	3.10	3.75	A	
		XPS = L, ILIMSEL = H	1.05	1.30	1.60	A	
		XPS = L, ILIMSEL = L	0.36	0.49	0.60	A	
Oscillation frequency	f_{OSC}	-	5.2	5.8	6.4	MHz	
Shutdown current	I_{SD}	EN = L	-	-	2	μ A	
Quiescent current	I_Q	EN = H, XPS = L, $V_{IN} = 3.7V$, $V_O = 3.3V$, $I_O = 0$ mA	-	50	-	μ A	
SW FET ON resistance	SW1	Rdson	$V_{DD} = 3.7V$, $V_O = 3.3V$, $T_a = +25^\circ C$	-	63.5	84	m Ω
	SW2			-	124	175	
	SW3			-	82	116	
	SW4			-	123	164	
	SW5			-	51	72	
Over temperature protection	T_{OTPH}	-	-	135(*1)	-	$^\circ C$	
	T_{OTPL}	-	-	110(*1)	-	$^\circ C$	
UVLO Threshold voltage	V_{UVLOH}	-	1.9	2.0	2.1	V	
	V_{UVLOL}	-	1.8	1.9	2.0	V	
Signal input threshold voltage	V_{IL}	EN, XPS, VSEL, ILIMSEL	0.0	-	0.25	V	
	V_{IH}	EN, XPS, VSEL, ILIMSEL	1.5	-	VDD	V	
Signal input current	I_{CTL}	EN, XPS, VSEL, ILIMSEL	-	-	0.1	μ A	

*1: This parameter is not be specified. This should be used as a reference to support designing the circuits.

8. Typical Applications Circuit (RF Power Amplifier)

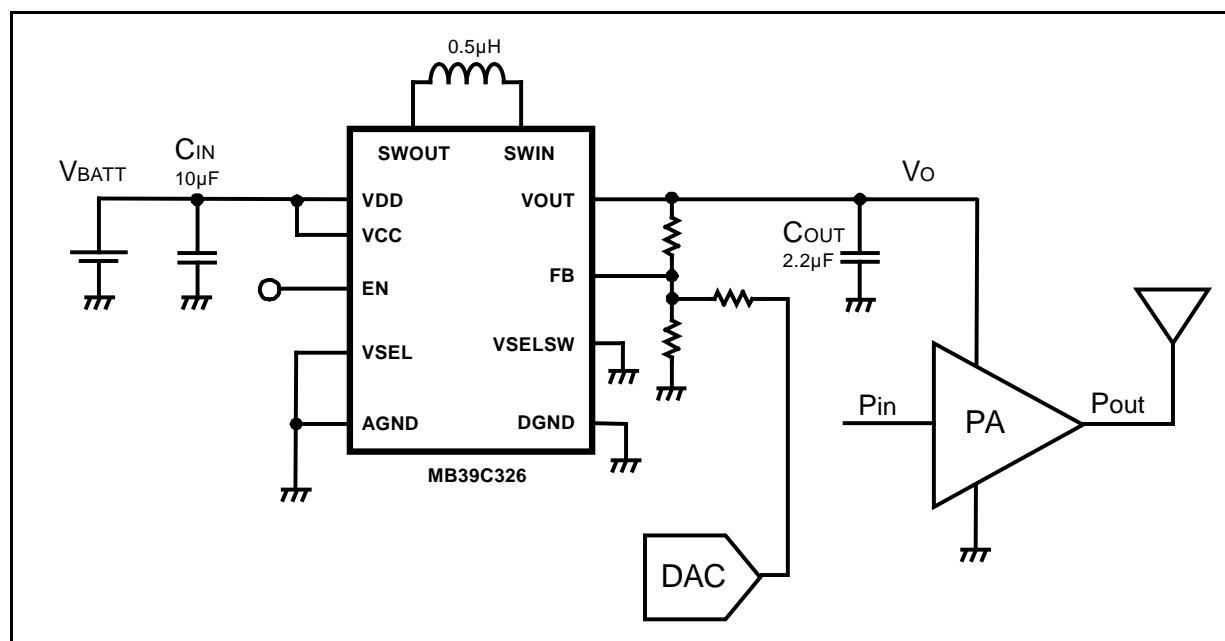

9. Application Notes

Programming the Output Voltage

Output voltage is calculated using the equation (1) below.

Use R1 resistor value of 620 kΩ. Built-in phase compensation circuit is generated according to this resistor value.

1. Not using a selectable voltage option

$$V_O = V_{FB} \times \frac{R_1 + R_2}{R_2}$$

($V_{FB} = 500 \text{ mV}$)

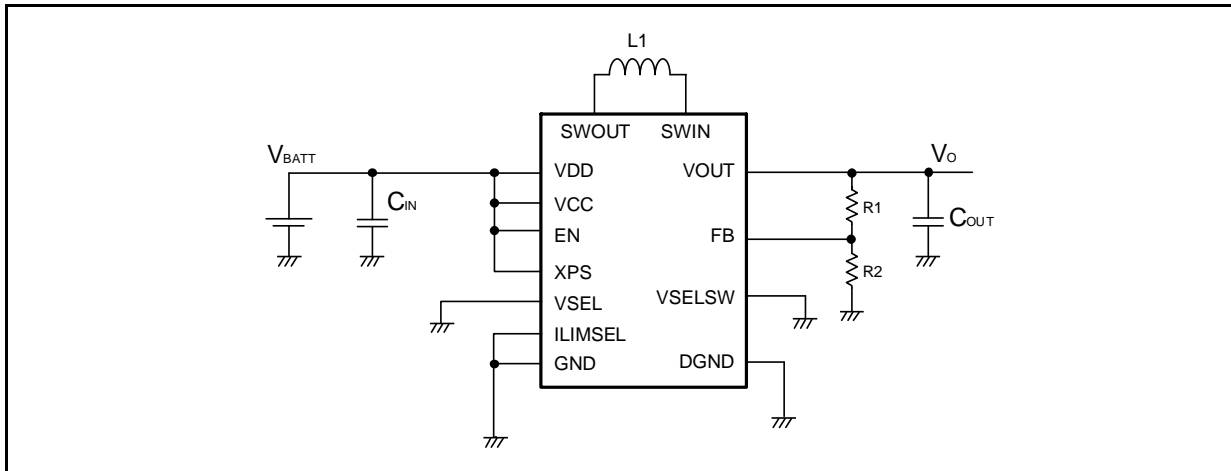

2. Using a selectable voltage option

When $VSEL = L$

$$V_O = V_{FB} \times \frac{R_1 + R_2}{R_2}$$

When $VSEL = H$

$$V_O = V_{FB} \times \frac{R_1}{R_2 // R_3} + \frac{R_2 // R_3}{R_2 // R_3}$$

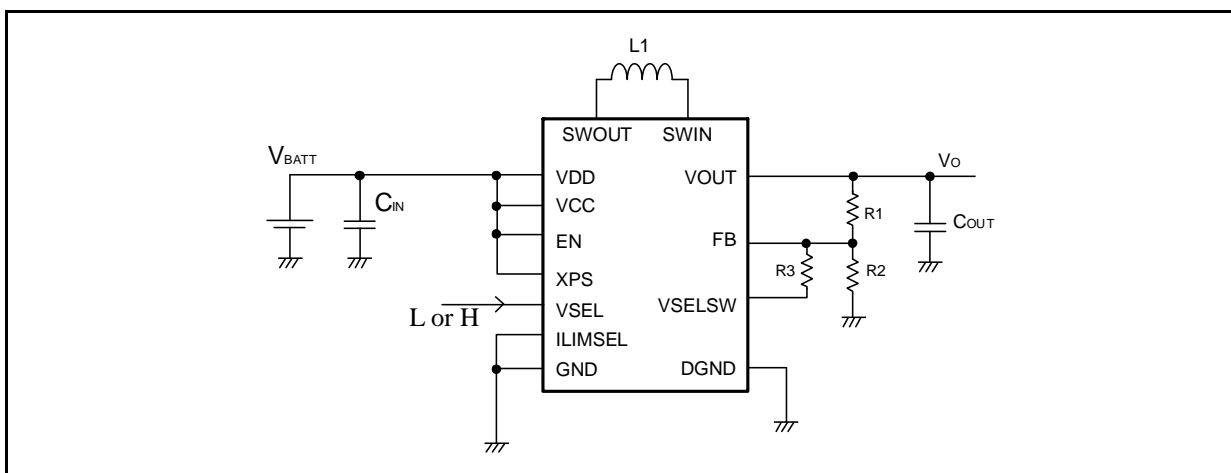

3. When the output variable is dynamically performed

$$V_O = - \frac{R_1}{R_3} \times V_{DAC} + V_{FB} \times \left(\frac{R_1}{R_3} + \frac{R_1}{R_2} + 1 \right)$$

($V_{FB} = 500 \text{ mV}$)

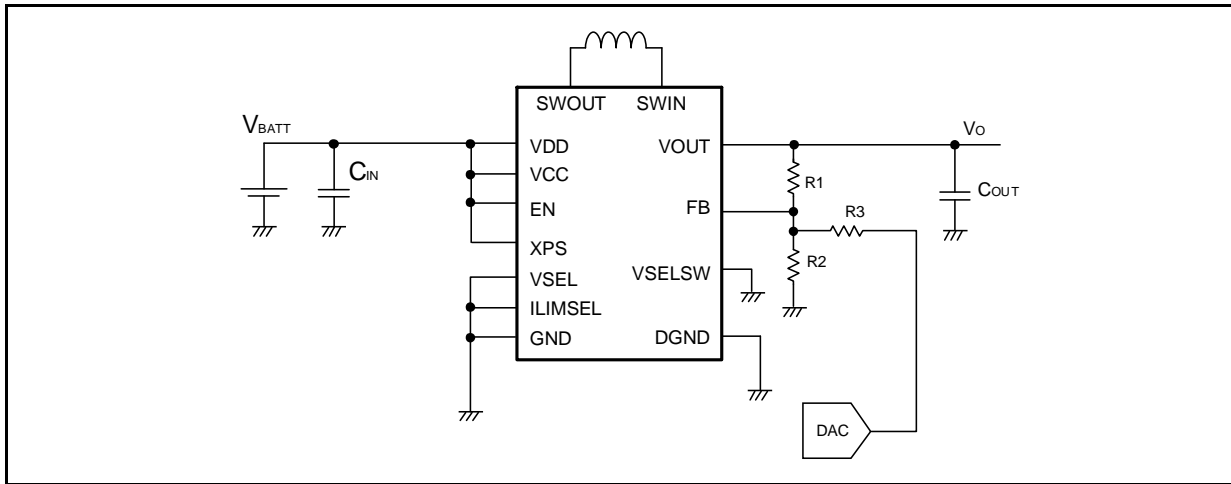

Relationship between DAC and output when setting to $R_1 = 620 \text{ k}\Omega$, $R_2 = 110 \text{ k}\Omega$ and $R_3 = 330 \text{ k}\Omega$

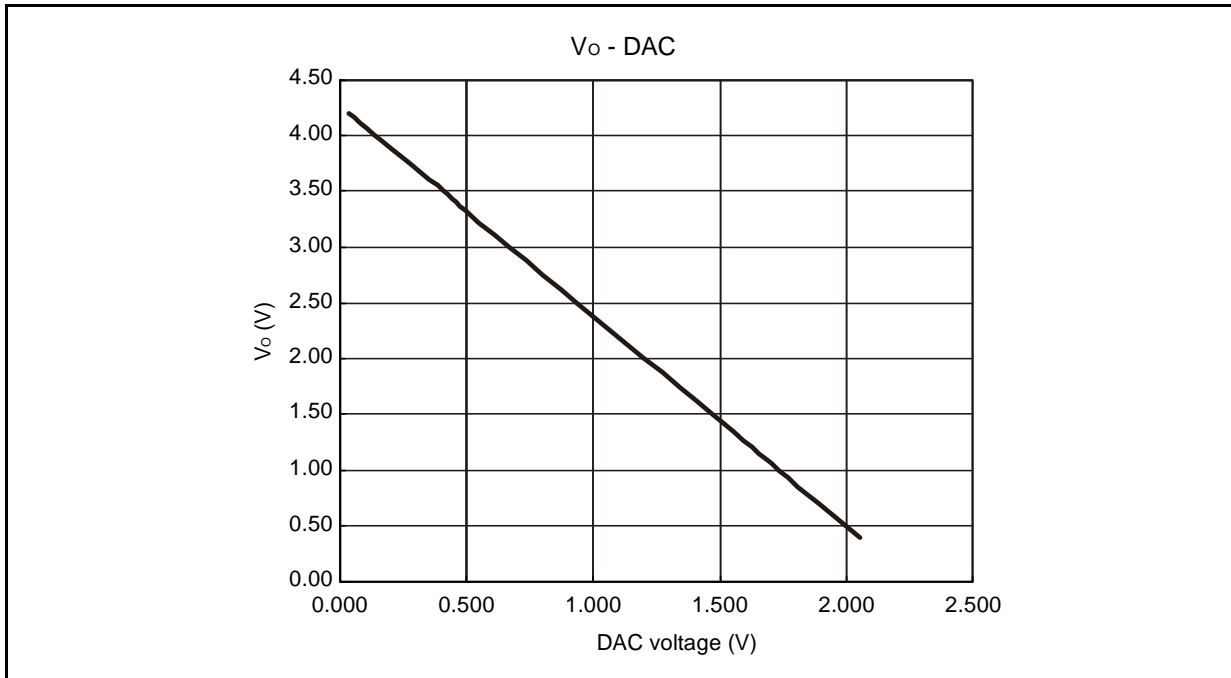

10. Inductor Selection

The recommended inductor is 0.5 μH (0.47 μH).

To acquire a high-efficiency, select an inductor with low ESR.

Confirm in use conditions that the coil current does not exceed the rated saturation current.

It is recommended that the switch current limit value is considered.

Note that the permissible current value might be low about some products with high ESR because of the device temperature increasing.

The following table shows the recommended inductor.

Vendor	Part #	Size			DCR[Ω] (max)	Isat[A] (-30%)
		L[mm]	W[mm]	H[mm]		
Coilcraft	XPL2010-501ML	1.9	2.0	1.0	0.045	2.64
ALPS	GLCHKR4701A	2.0	1.6	1.0	0.035	3.6

Coilcraft : Coilcraft, Inc.

ALPS : Alps Green Devices Co., Ltd

11. Input Capacitor Selection

It is recommended to place a low ESR ceramic bypass capacitor at least 10 μF close to VDD and GND because the input capacitor is the power-supply voltage.

The execution capacity of some ceramic capacitors greatly decreases when adding bias.

Select a product by checking the part characteristics of manufacturer because small size parts or low voltage rating parts tend to have that characteristic.

12. Output Capacitor Selection

The recommended standard capacity of the output capacitor is 2.2 μF in PWM mode.

When using in power save mode, the capacitor with larger capacity (around 22 μF) is recommended to reduce the ripple voltage at PFM operation.

To suppress the decrease of output voltage during the load change, adjust with a larger capacitor.

Larger capacitors and low ESR capacitors is useful to reduce the ripple.

13. Thermal Information

Power dissipation is 1080 mW Max.

Thermal resistance(θ_{ja}) is 65 $^{\circ}\text{C}/\text{W}$ (JEDEC). This value can be used to calculate the chip temperature.

Thermal resistance is calculated based on the usage of JEDEC standard boards. It is recommended to consider for the thermal design that the value may vary depending on the area of the board and the positions of the vias.

See "Power dissipation vs. Operation ambient temperature" in "15. Example of Standard Operation".

15. Example of Standard Operation Characteristics

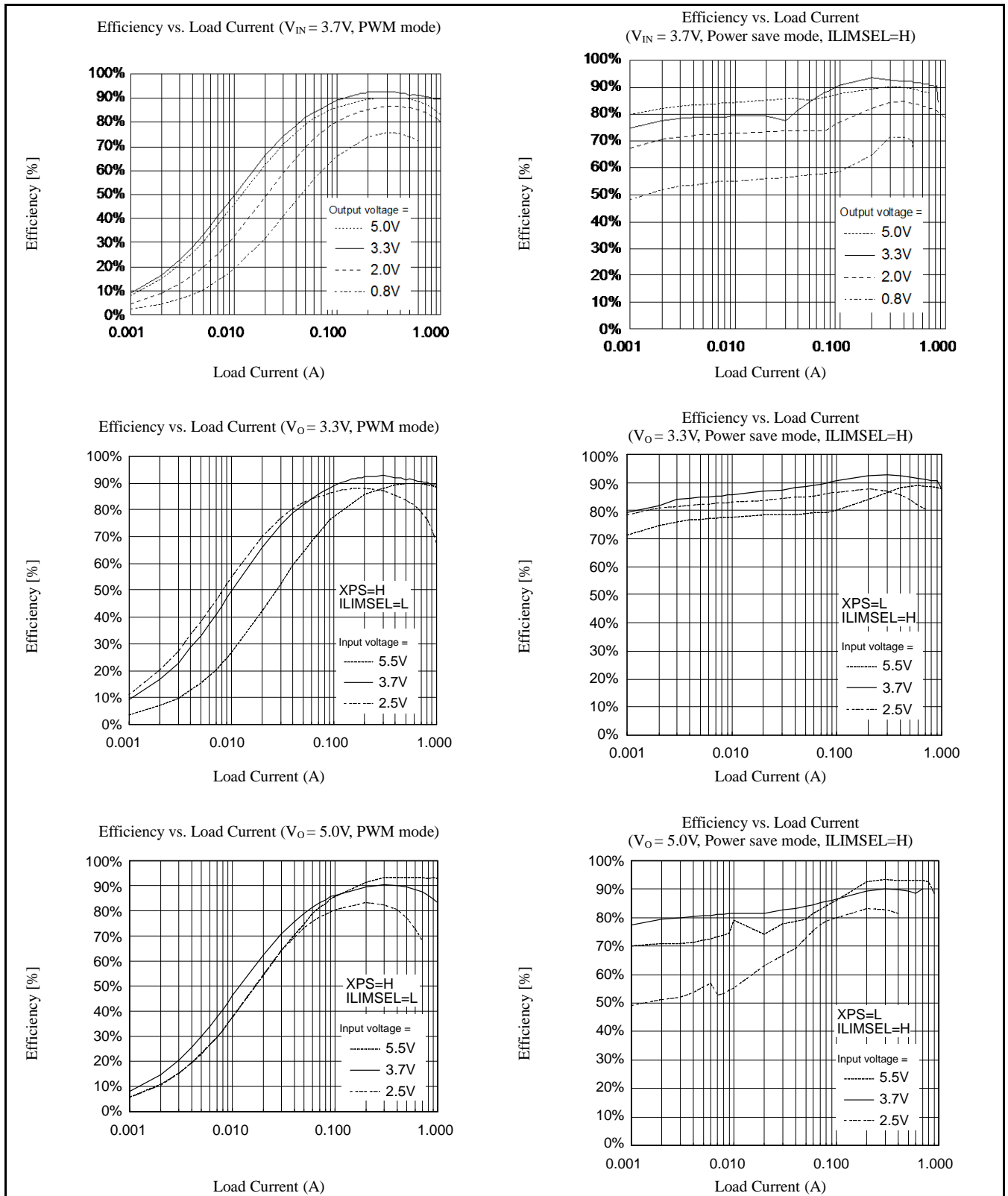

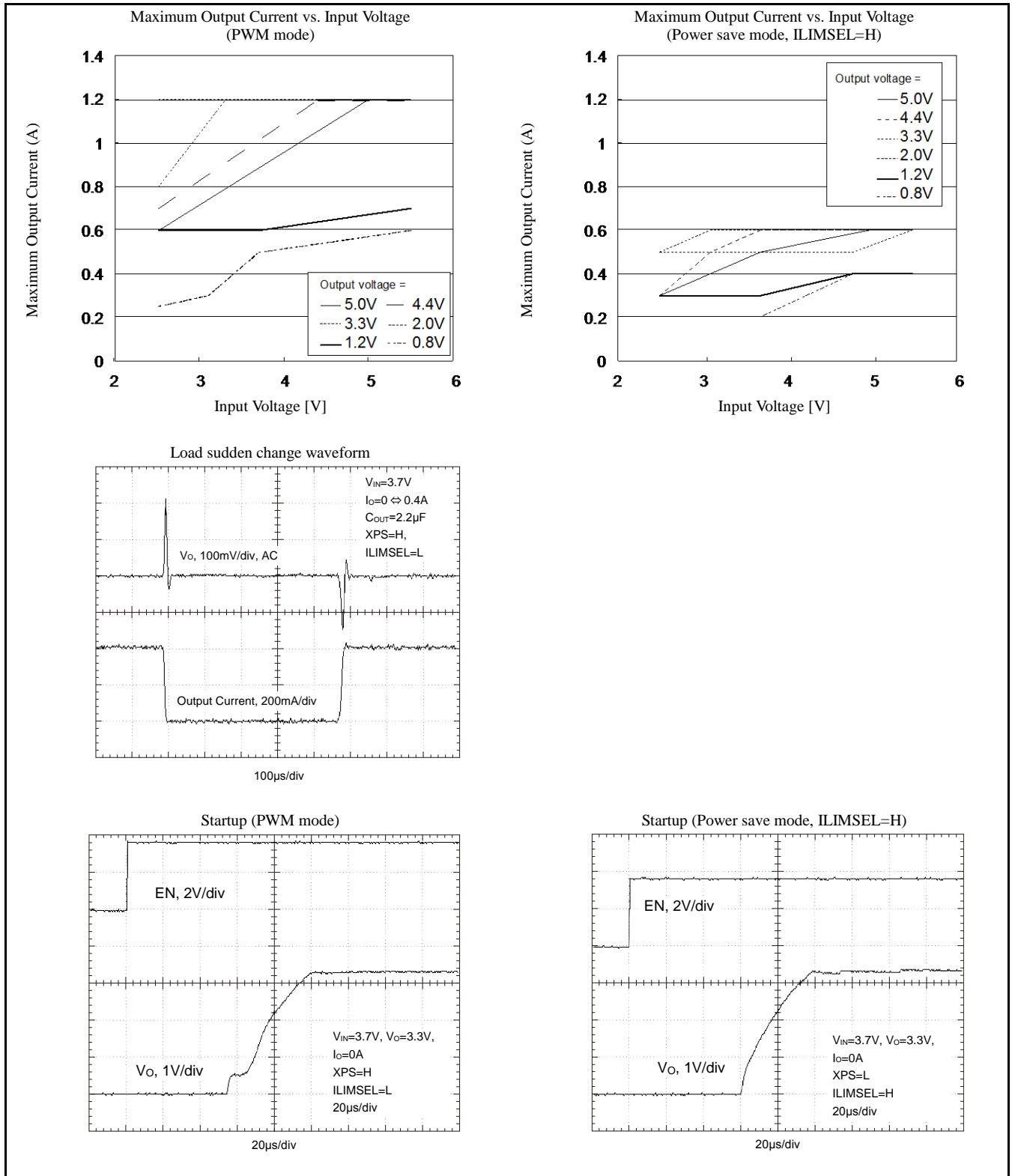

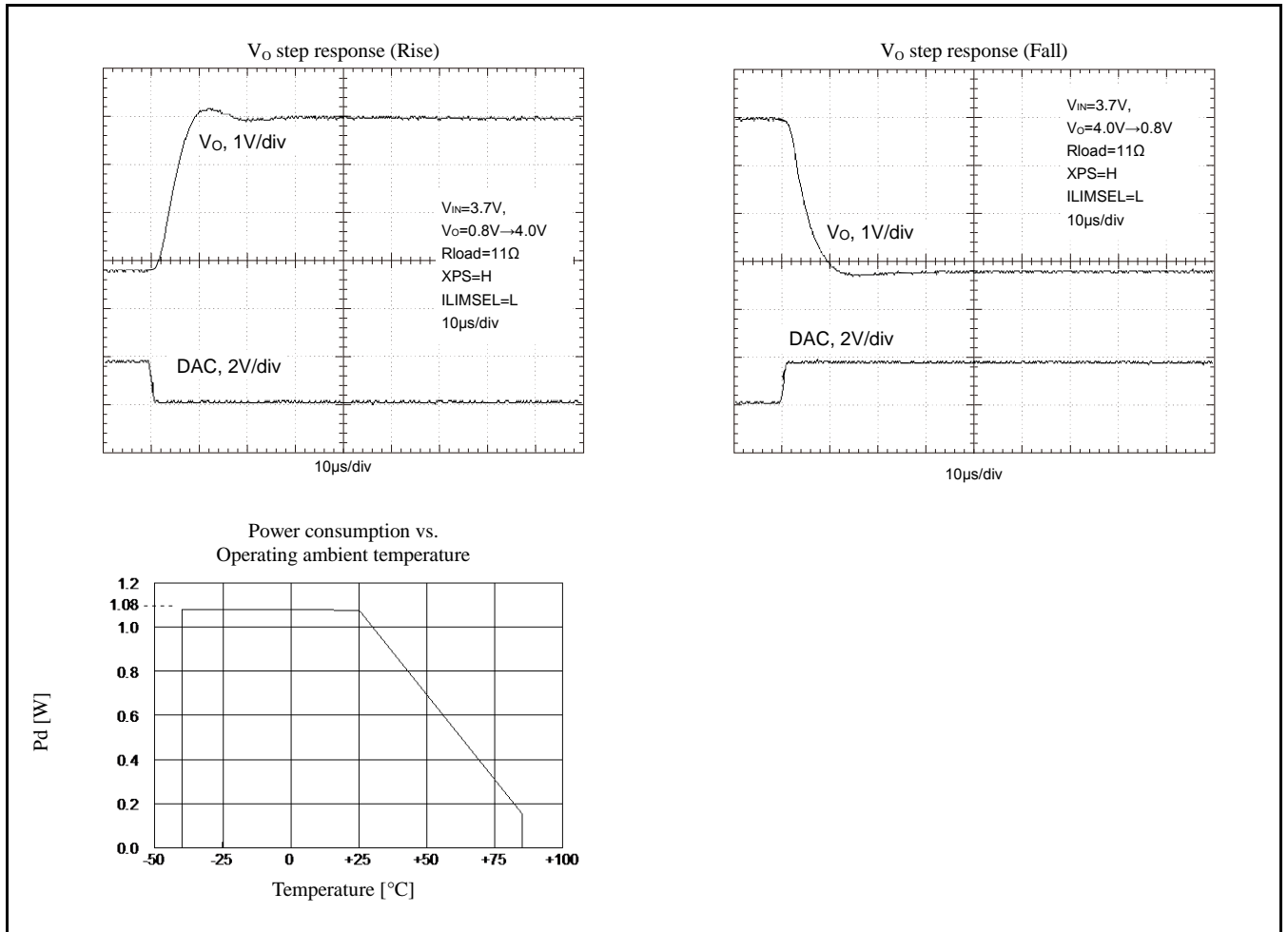

16. Usage Precaution

- Do not configure the IC over the maximum ratings.

If the IC is used over the maximum ratings, the LSI may be permanently damaged.

It is preferable for the device to be normally operated within the recommended usage conditions. Usage outside of these conditions can have a bad effect on the reliability of the LSI.

- Use the devices within recommended operating conditions.

The recommended operating conditions are the recommended values that guarantee the normal operations of LSI.

The electrical ratings are guaranteed when the device is used within the recommended operating conditions and under the conditions stated for each item.

- Printed circuit board ground lines should be set up with consideration for common impedance.

- Take appropriate measures against static electricity.

- Containers for semiconductor materials should have anti-static protection or be made of conductive material.
- After mounting, printed circuit boards should be stored and shipped in conductive bags or containers.
- Work platforms, tools, and instruments should be properly grounded.
- Working personnel should be grounded with resistance of 250 k Ω to 1 M Ω in series between body and ground.

- Do not apply negative voltages.

The use of negative voltages below -0.3V may cause the parasitic transistor to be activated on LSI lines, which can cause malfunctions.

17. Notes on Mounting

In general, the underfill material and sealing method affect the reliability of mounting.

Cypress does not evaluate the mounting using the underfill material.

It is advisable for each customer to evaluate the mounting enough.

WL-CSP has a surface boundary between silicon and resin at the side of the package.

Resin may be pulled by the board because of the underfill material and its shape and the state, and stress may occur at the surface boundary.

The result may vary depending on the board and the underfill material used by each customer; therefore, it is advisable for each customer to evaluate the mounting enough in order to apply to the products.

When using the underfill materials, be sure to apply the underfill to the silicon side surface as shown below (fillet formation).

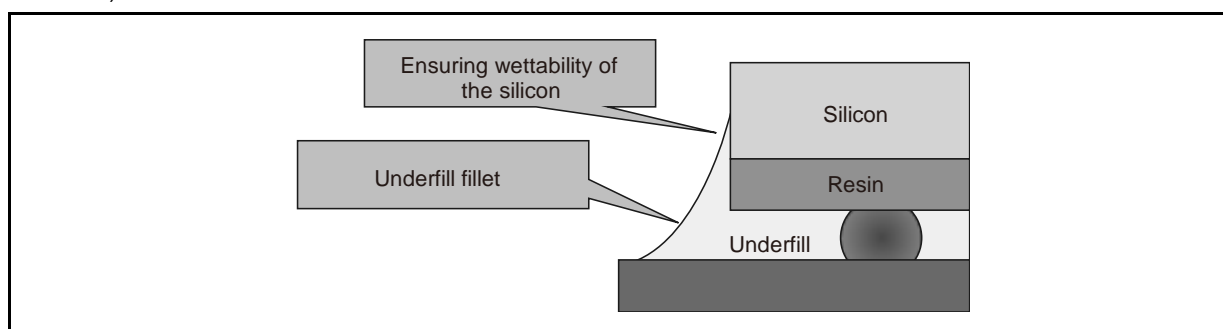

18. Ordering Information

Part Number	Package	Remarks
MB39C326PW	20-pin plastic WLP (WLP-20P-M01)	

19. EV Board Ordering Information

EV Board Number	EV Board Version No.	Remarks
MB39C326-EVBSK-01	MB39C326-EVB-01 REV1.2	20pin-WL-CSP, Power save mode
MB39C326-EVBSK-02	MB39C326-EVB-01 REV1.2	20pin-WL-CSP, PWM mode

20. RoHS Compliance Information of Lead (Pb) Free Version





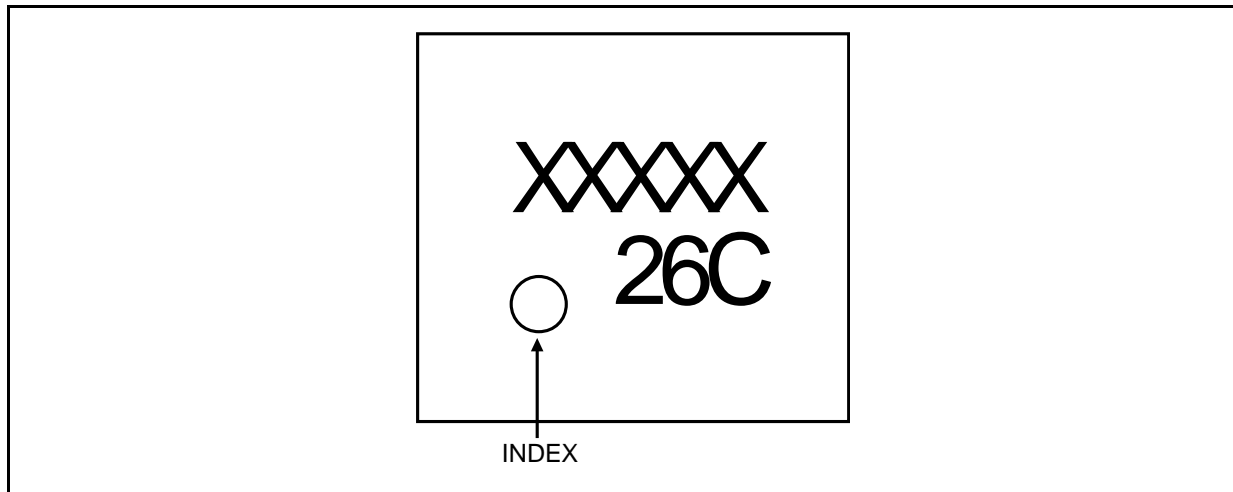















The LSI products of Cypress with "E1" are compliant with RoHS Directive, and has observed the standard of lead, cadmium, mercury, Hexavalent chromium, polybrominated biphenyls (PBB), and polybrominated diphenyl ethers (PBDE). A product whose part number has trailing characters "E1" is RoHS compliant.

21. Marking



22. Labeling Sample

Figure 22-1 Inner box label [Q-Pack label (4 × 8.5inch)]

		1234	
RoHS	2Lj	12345678901234567890 1234567	
Category=	12		
SPEC#	123456789012345678		
IDV	1234567890	PKG	123456 FULL CNTR QTY 1234
			
(1P) MFR#	123456789012345678901234		
(P) OPN	123456789012345678901234		
(1Z) BOX ID			
LOT#	1234567		
HU		123	BOX OF 123
HULN	1234567890123		
(1T) BATCH#	1234567000 		
			
12345678901234567890123		123456789012345	
			
SEAL DC	12345678	TTL QTY (Q)	12345 
ASSEMBLED IN:	12	1234567890123456789012345	
12345678901234567890			
12345678901234567890			
12345678901234567890			
123456789012345			
(9D)M/C: 1001HH071	(7Q)QTY: 02500PC		
			
12345678 12345678	12345678 1234567		
			
12345678 12345678	12345678 1234567		
			
12345678 12345678	12345678 1234567		
			
12345678 12345678	12345678 1234567		
			
12345678 12345678	12345678 1234567		
			
12345678 12345678	12345678 1234567		

Ordering Part Number (P)+Part No.

Quantity

Mark lot information

Label spec : Conformable JEDEC
Barcode form : Code 39

Figure 22-2 Al(Aluminum) bag label [2-in-1 label (4 × 8.5inch)]

(P) OPN: 123456789012345678901234



(1P) MFR# 123456789012345678901234



(1T) BATCH# 1234567 000



SEAL DC: 12345678
 123456789012345
 (9D)M/C: 0011H021

(7Q)QTY: 02500PC



12345678 12345678 12345678 12345678



12345678 12345678 12345678 12345678



12345678 12345678 12345678 12345678

12345678 12345678 12345678 12345678



12345678 12345678 12345678 12345678



12345678 12345678 12345678 12345678

(Q) TTL QTY: 1234;

LOT# 1234567 BAG ID: 1234 QTY: 1234
 (Z) BAG ID: 

Caution
 JEDEC MSL, if available.

 RoHS 2Li

 Pb

CAUTION
 This Bag Contains
 MOISTURE SENSITIVE DEVICES
 Category - 12

JEDEC
 LEVEL
3

JEITA
 RANK
E

1. Calculated shelf life in sealed bag: 12 months at < 40 °C and < 90 % relative humidity (RH)
2. Peak package body temperature: 123 + 0 °C / - 5 °C
3. After bag is opened, devices that will be subjected to solder reflow or other high temperature process must:
 - a) Mounted within 1234567890 of factory conditions < 30 °C / 70 % RH, OR
 - b) Stored per J-STD-033
4. Devices require bake, before mounting, if:
 - a) Humidity Indicator Card is > 10 % for level 2a - 5a devices or > 60 % for level 2 devices when read at 23 °C ± 5 °C
 - b) 3a or 3b not met
5. If baking is required, devices may be baked for 24 hours at 125 °C ± 5 °C. Refer J-STD-033 for shorter time durations, if applicable

Note: If device containers cannot be subjected to high temperature or shorter bake times are desired, reference IPC/JEDEC J-STD-033 for bake reference

Bag Seal Date : 1234567 
 (If blank, see adjacent bar code label)

Note: Level and body temperature defined by IPC/JEDEC J-STD-020 for JEDEC and EIAJ-ED 4701/300 for JEITA

Figure 22-3 Reel label [Reel label (4 x 2.5inch)]

(P) OPN: 123456789012345678901234	Ordering Part Number (P)+Part No.
(1P) MFR# 123456789012345678901234	
(1T) BATCH# 1234567 000	Mark lot information
123456789012345	
(9D) M/C: 001HH071	(7Q) QTY: 02500PC
(9D) M/C: 001HH072	(7Q) QTY: 02500PC
12345678 12345678	12345678 12345678
12345678 12345678	12345678 12345678
(Q) TTL QTY: 1234	LOT# 1234567

Quantity

Figure 22-4 Reel label [Dry pack & Reel label (4 x 2.5inch)]



ATTENTION
CONTAINS
MOISTURE AND
ELCTROSTATIC
SENSITIVE DEVICES

DO NOT OPEN OR HANDLE
EXCEPT AT A CERTIFIED
STATIC SAFE WORK STATION
AND IN ACCOERDANCE WITH
HUMIDITY CONTROL HANDLING
PROCEDURES

Figure 22-5 Outer box label [Shopping label (4 x 8.5inch)]

Quantity	Ordering Part Number : (1P)+Part No.	
(3S) PKG ID: 80000599	FROM: Spansion LLC and its affiliates 315 DeGuigne Drive, P.O. Box 3450 SUNNYVALE, CA 94088-3450	
(1P) MFR P/N: 123456789012345678901234	SHIP TO: 1234567890123456789012345678901234567890 1234567890123456789012345678901234567890 1234567890123456789012345678901234567890 1234567890123456789012345678901234567890 1234567890123456789012345678901234567890 1234567890123456789012345678901234567890 1234567890123456789012345678901234567890	
(Q) QUANTITY: 12345678 EA	(4L) CTRY OF ORIGIN: 12	PACKAGE WEIGHT: 12345678 LB PRINTED: 123456
(K) TRANS ID: 12345678901234567890123456789012345	DESC: I. C.	HU NO. 1234567890123
(P) CUST PROD ID: 123456789012345678901234	CTRY OF DIFFUSION: 12 12 12 12 12 12 ASSEMBLED IN: 123456789012345	DEL NO. 80000599

23. MB39C326PW Recommended Conditions of Moisture Sensitivity Level

[Cypress Recommended Mounting Conditions]

Item	Condition	
Mounting Method	IR (infrared reflow), warm air reflow	
Mounting times	2 times	
Storage period	Before opening	Please use it within two years after manufacture.
	From opening to the 2nd reflow	
Storage conditions	5°C to 30°C, 70% RH or less (the lowest possible humidity)	

[Parameters for Each Mounting Method]

IR (infrared reflow)

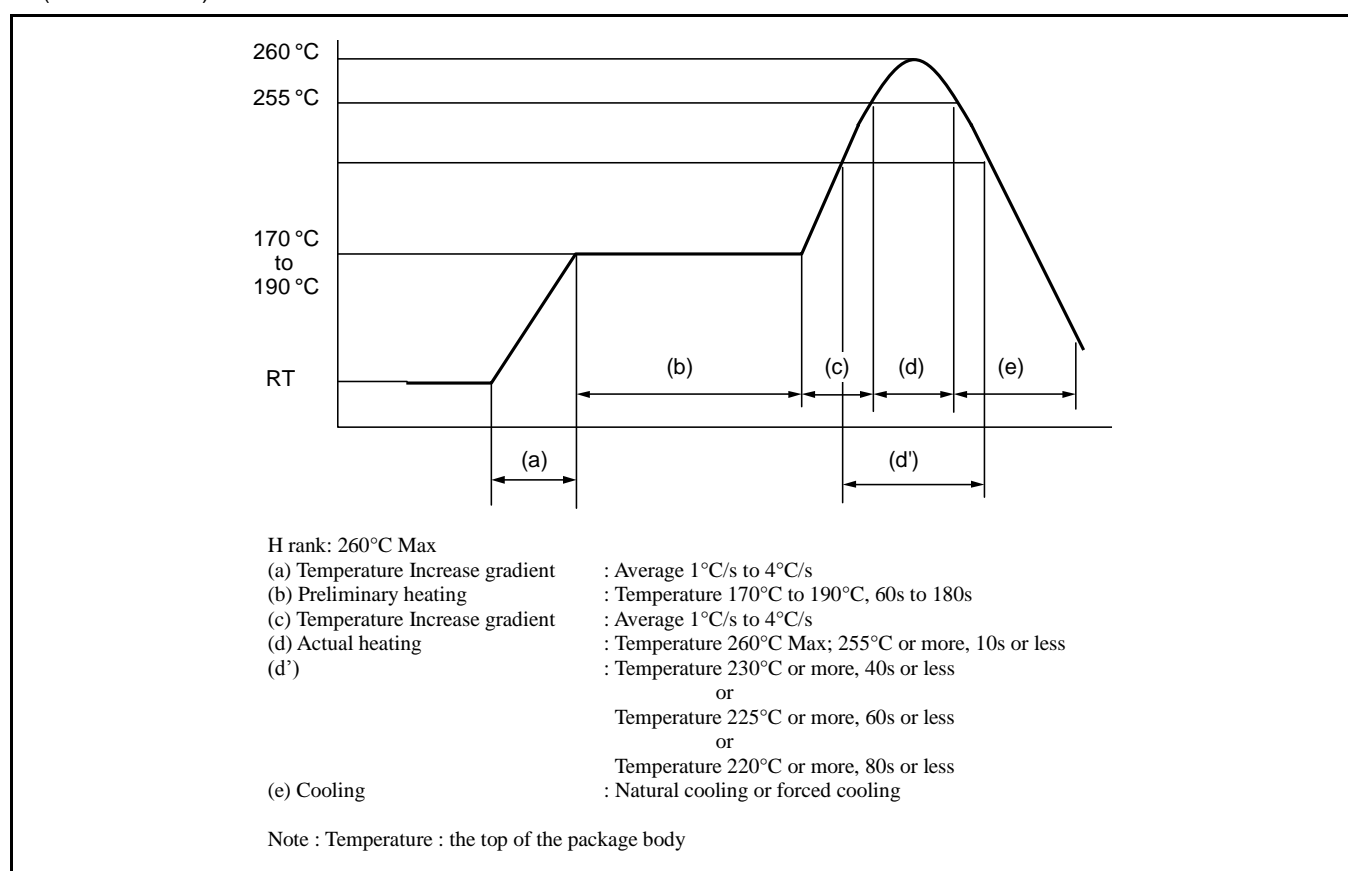

24. Package Dimensions

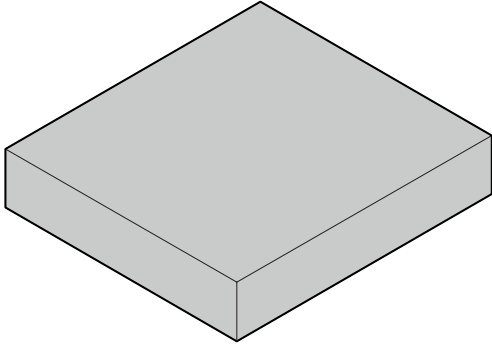
<p style="text-align: center;">20-pin plastic WLP</p>  <p style="text-align: center;">(WLP-20P-M01)</p>	Lead pitch	0.4 mm
	Package width × package length	2.15 mm × 1.94
	Lead shape	Soldering ball
	Sealing method	Print
	Mounting height	0.625 mm Max.
	Weight	0.005 g
	Code (Reference)	S-WF BGA20-2.15 × 1.94-0.40

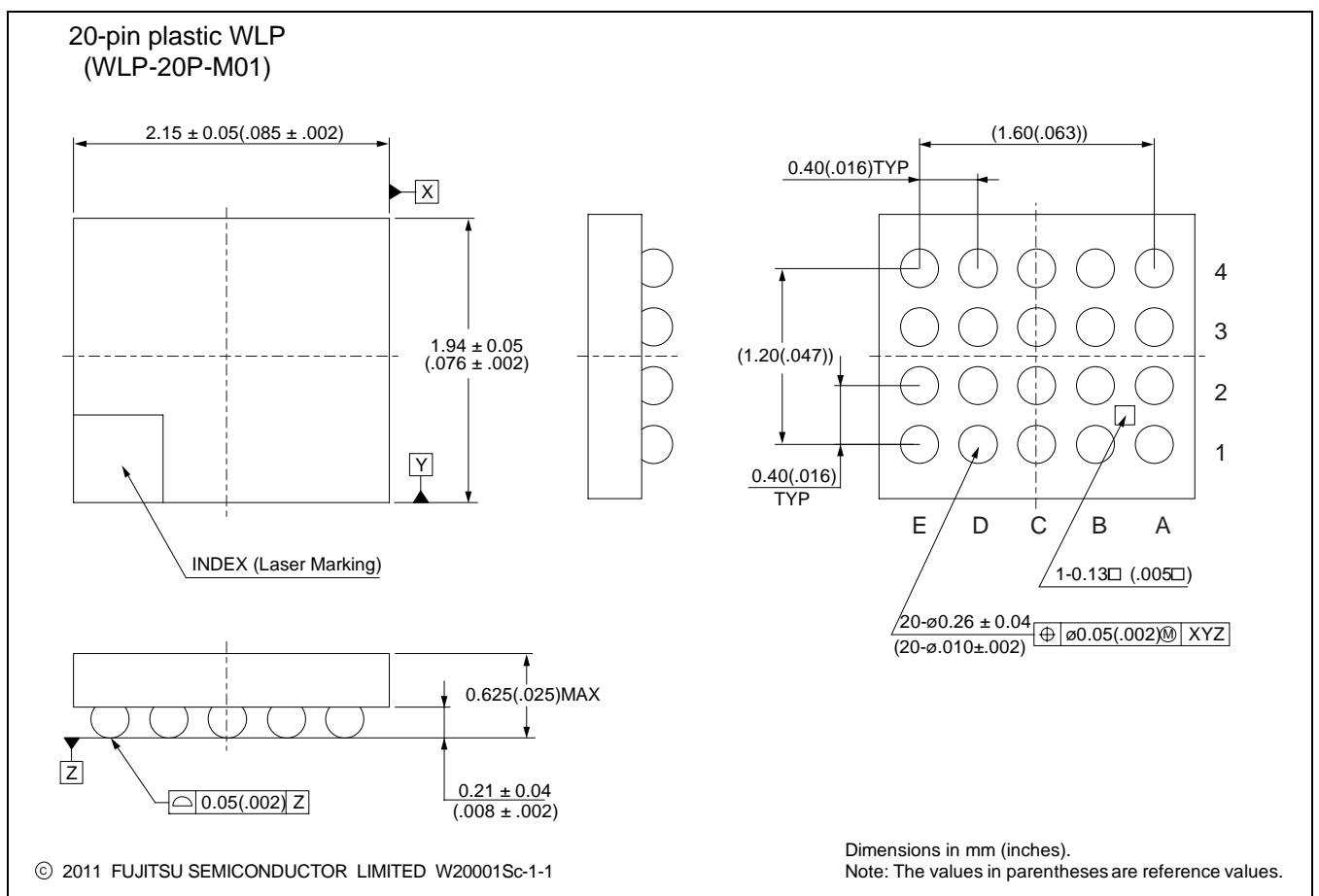

25. Major Changes

Spanion Publication Number: MB39C326_DS405-00001

Page	Section	Change Results
Revision 1.0		
-	-	Initial release

NOTE: Please see “Document History” about later revised information.

Document History

Document Title: MB39C326 6MHz Synchronous Rectification Buck-Boost DC/DC Converter IC

Document Number: 002-08348

Revision	ECN	Orig. of Change	Submission Date	Description of Change
**	—	TAOA	01/31/2014	Migrated to Cypress and assigned document number 002-08348. No change to document contents or format.
*A	5131396	TAOA	02/10/2016	Updated to Cypress template

Sales, Solutions, and Legal Information

Worldwide Sales and Design Support

Cypress maintains a worldwide network of offices, solution centers, manufacturer's representatives, and distributors. To find the office closest to you, visit us at [Cypress Locations](#).

Products

Automotive	cypress.com/go/automotive
Clocks & Buffers	cypress.com/go/clocks
Interface	cypress.com/go/interface
Lighting & Power Control	cypress.com/go/powerpsoc
Memory	cypress.com/go/memory
PSoC	cypress.com/go/psoc
Touch Sensing	cypress.com/go/touch
USB Controllers	cypress.com/go/USB
Wireless/RF	cypress.com/go/wireless
Spansion Products	cypress.com/spansion products

PSoC® Solutions

[psoc.cypress.com/solutions](#)

[PSoC 1](#) | [PSoC 3](#) | [PSoC 4](#) | [PSoC 5LP](#)

Cypress Developer Community

[Community](#) | [Forums](#) | [Blogs](#) | [Video](#) | [Training](#)

Technical Support

[cypress.com/go/support](#)

Cypress®, the Cypress logo, Spansion®, the Spansion logo, MirrorBit®, MirrorBit® Eclipse™, ORNAND™, Easy DesignSim™, Traveo™ and combinations thereof, are trademarks and registered trademarks of Cypress Semiconductor Corp. ARM and Cortex are the registered trademarks of ARM Limited in the EU and other countries. All other trademarks or registered trademarks referenced herein are the property of their respective owners.

© Cypress Semiconductor Corporation, 2014-2016. The information contained herein is subject to change without notice. Cypress Semiconductor Corporation assumes no responsibility for the use of any circuitry other than circuitry embodied in a Cypress product. Nor does it convey or imply any license under patent or other rights. Cypress products are not warranted nor intended to be used for medical, life support, life saving, critical control or safety applications, unless pursuant to an express written agreement with Cypress. Furthermore, Cypress does not authorize its products for use as critical components in life-support systems where a malfunction or failure may reasonably be expected to result in significant injury to the user. The inclusion of Cypress products in life-support systems application implies that the manufacturer assumes all risk of such use and in doing so indemnifies Cypress against all charges.

This Source Code (software and/or firmware) is owned by Cypress Semiconductor Corporation (Cypress) and is protected by and subject to worldwide patent protection (United States and foreign), United States copyright laws and international treaty provisions. Cypress hereby grants to licensee a personal, non-exclusive, non-transferable license to copy, use, modify, create derivative works of, and compile the Cypress Source Code and derivative works for the sole purpose of creating custom software and or firmware in support of licensee product to be used only in conjunction with a Cypress integrated circuit as specified in the applicable agreement. Any reproduction, modification, translation, compilation, or representation of this Source Code except as specified above is prohibited without the express written permission of Cypress.

Disclaimer: CYPRESS MAKES NO WARRANTY OF ANY KIND, EXPRESS OR IMPLIED, WITH REGARD TO THIS MATERIAL, INCLUDING, BUT NOT LIMITED TO, THE IMPLIED WARRANTIES OF MERCHANTABILITY AND FITNESS FOR A PARTICULAR PURPOSE. Cypress reserves the right to make changes without further notice to the materials described herein. Cypress does not assume any liability arising out of the application or use of any product or circuit described herein. Cypress does not authorize its products for use as critical components in life-support systems where a malfunction or failure may reasonably be expected to result in significant injury to the user. The inclusion of Cypress' product in a life-support systems application implies that the manufacturer assumes all risk of such use and in doing so indemnifies Cypress against all charges.

Use may be limited by and subject to the applicable Cypress software license agreement.