

G3VM-□BR□/□ER□

MOS FET Relays DIP 6-pin, High-current and Low-ON-resistance Type

MOS FET Relays in DIP 6-pin packages that achieve the low ON resistance and high switching capacity of a mechanical relay

- Load voltage: 20 V, 30 V, 40 V, 60 V, or 100 V
- 20-V Relay: Continuous load current of 4 A (8 A) max. *
- 30-V Relay: Continuous load current of 5 A (10 A) max. *
- 40-V Relay: Continuous load current of 3.5 A (7 A) max. *
- 60-V Relay: Continuous load current of 4 A (8 A) max. *
- 100-V Relay: Continuous load current of 3.5 A (7 A) max. *

* Values in parentheses are for connection C.

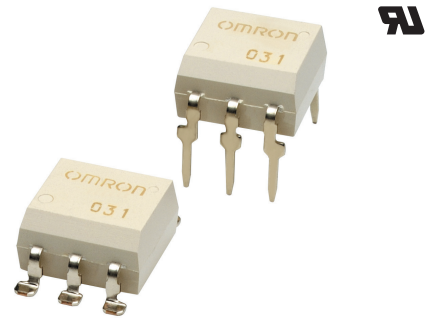

Note: The actual product is marked differently from the image shown here.

RoHS Compliant

Application Examples

- Communication equipment
- Security equipment
- Test & Measurement equipment
- Industrial equipment

Package

(Unit : mm, Average)

DIP 6-pin
PCB Terminals

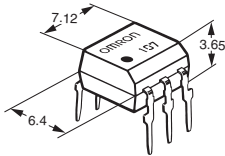

Surface-mounting Terminals

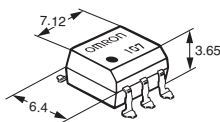

Note: The actual product is marked differently from the image shown here.

Model Number Legend

G3VM-□□□□□
1 2 3 4 5

- 1. Load Voltage**
2 : 20 V
3 : 30 V
4 : 40 V
6 : 60 V
10 : 100 V
- 2. Contact form**
1 : 1a (SPST-NO)
- 3. Package**
B : DIP 6-pin with PCB terminals
E : DIP 6-pin with surface-mounting terminals
- 4. Additional functions**
R : Low ON resistance
- 5. Other informations**
When specifications overlap, serial code is added in the recorded order.

Ordering Information

Package	Contact form	Load voltage (peak value) *	Continuous load current (peak value) *		Stick packaging			Tape packaging	
			Connection A, B	Connection C	Model	Minimum package quantity	Model	Minimum package quantity	
DIP6	1a (SPST-NO)	20 V	4 A	8 A	G3VM-21BR	G3VM-21ER	50 pcs.	G3VM-21ER(TR)	1,500 pcs.
		30 V	5 A	10 A	G3VM-31BR	G3VM-31ER		G3VM-31ER(TR05)	500 pcs.
		40 V	3.5 A	7 A	G3VM-41BR	G3VM-41ER		G3VM-41ER(TR)	1,500 pcs.
		60 V	2.5 A	—	G3VM-61BR	G3VM-61ER		G3VM-61ER(TR)	
			3 A	6 A	G3VM-61BR1	G3VM-61ER1		G3VM-61ER1(TR)	
		100 V	4 A	8 A	G3VM-61BR2	G3VM-61ER2		G3VM-61ER2(TR05)	500 pcs.
			2 A	4 A	G3VM-101BR	G3VM-101ER		G3VM-101ER(TR)	1,500 pcs.
			3.5 A	7 A	G3VM-101BR1	G3VM-101ER1		G3VM-101ER1(TR05)	500 pcs.

* The AC peak and DC value are given for the load voltage and continuous load current.

Note: To order tape packaging for Relays with surface-mounting terminals, add "(TR)" to the end of the model number.

■ Absolute Maximum Ratings (Ta = 25°C)

Item	Symbol	G3VM-21BR	G3VM-31BR	G3VM-41BR	G3VM-61BR	G3VM-61BR1	G3VM-61BR2	G3VM-101BR	G3VM-101BR1	Unit	Measurement conditions			
		G3VM-21ER	G3VM-31ER	G3VM-41ER	G3VM-61ER	G3VM-61ER1	G3VM-61ER2	G3VM-101ER	G3VM-101ER1					
Input	LED forward current	IF									30	mA		
	Repetitive peak LED forward current	IFP									1	A	100 μs pulses, 100 pps	
	LED forward current reduction rate	ΔIF/°C									-0.3	mA/°C	Ta ≥ 25°C	
	LED reverse voltage	VR		5	6	5			6	5	6	V		
Connection temperature		TJ									125		°C	
Load voltage (AC peak/DC)		VOFF		20	30	40	60		100		V			
Output	Continuous load current	Connection A	Io	4	5	3.5	2.5	3	4	2	3.5	A	Connection A: AC peak/DC Connection B and C: DC	
		Connection B		8	10	7	-	6	8	4	7			
		Connection C												
	ON current reduction rate	Connection A	ΔIo/°C	-40	-50	-35	-22	-30	-40	-20	-35	mA/°C	Ta ≥ 25°C	
		Connection B		-80	-100	-70	-	-60	-80	-40	-70			
Connection C														
Pulse ON current		Iop		12	15	10.5	7.5	9	12	6	10.5	A	t=100 ms, Duty=1/10	
Connection temperature		TJ									125		°C	
Dielectric strength between I/O *		VI-O									2,500		Vrms	AC for 1 min
Ambient operating temperature		Ta		-40 to +85	-40 to +110	-40 to +85	-20 to +85	-40 to +85	-40 to +110	-40 to +85	-40 to +110	°C	With no icing or condensation	
Ambient storage temperature		Tstg			-55 to +125		-40 to +125	-55 to +125			°C			
Soldering temperature		-									260		°C	10 s

* The dielectric strength between the input and output was checked by applying voltage between all pins as a group on the LED side and all pins as a group on the light-receiving side.

Connection Diagram

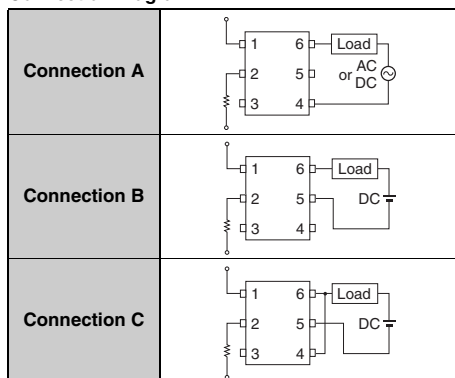

Note: Only connection A can be used for the G3VM-61BR/ER.

■Electrical Characteristics (Ta = 25°C)

Item	Symbol		G3VM-21BR	G3VM-31BR	G3VM-41BR	G3VM-61BR	G3VM-61BR1	G3VM-61BR2	G3VM-101BR	G3VM-101BR1	Unit	Measurement conditions	
			G3VM-21ER	G3VM-31ER	G3VM-41ER	G3VM-61ER	G3VM-61ER1	G3VM-61ER2	G3VM-101ER	G3VM-101ER1			
LED forward voltage	V _F	Minimum	1.18	1.5	1.18		1.5	1.18	1.5	V	I _F =10 mA		
		Typical	1.33	1.64	1.33		1.64	1.33	1.64				
		Maximum	1.48	1.8	1.48		1.8	1.48	1.8				
Reverse current	I _R	Maximum	10									μA	V _R =5 V
Capacitance between terminals	C _T	Typical	70									pF	V=0, f=1 MHz
Trigger LED forward current	I _{FT}	Typical	0.5	0.2	0.5	1	0.5	0.3	0.5	0.2	mA	I _o =1 A	
		Maximum	3										
Release LED forward current	I _{FC}	Minimum	0.1	0.01	0.1		0.01	0.1	0.01	0.01	mA	I _{OFF} =10 μA	
Maximum resistance with output ON	R _{ON}	Connection A	Typical	20		30	65	40	35	100	50	mΩ	G3VM-21BR/21ER/41BR/41ER/61BR1/61ER1/101BR/101ER: I _F =5 mA, I _o =2 A G3VM-61BR/61ER: I _F =10 mA, t=10 ms, I _o =2 A G3VM-31BR/31ER/61BR2/61ER2/101BR1/101ER1: I _F =5 mA I _o =3 A t < 1 s
			Maximum	50	40	60	100	70	60	200	80		
		Connection B	Typical	10		15	-	20	18	50	24		
Connection C	Typical	5		8	-	10	9	25	12	G3VM-21BR/21ER/41BR/41ER/61BR1/61ER1/101BR/101ER: I _F =5 mA, I _o =10 A, t < 1 s G3VM-61BR2/61ER2: I _F =5 mA, I _o =8 A, t < 1 s G3VM-101BR1/101ER1: I _F =5 mA, I _o =7 A, t < 1 s			
Current leakage when the relay is open	I _{LEAK}	Typical	-	0.01	-	0.001	-	0.01	-	0.01	μA	V _{OFF} =Load voltage ratings	
		Maximum	1		0.01	1							
Capacitance between terminals	C _{OFF}	Typical	1000	1100	1000	400	1100	640	1000	450	pF	V=0, f=1 MHz	
Capacitance between I/O terminals	C _{I-O}	Typical	0.8									pF	f=1 MHz, V _s =0 V
Insulation resistance between I/O terminals	R _{I-O}	Minimum	1000									MΩ	V _{I-O} =500 VDC, R _{oH} ≤ 60%
		Typical	10 ⁸										
Turn-ON time	t _{ON}	Typical	2.5	0.8	2	1.5	2	1.2	2	0.8	ms	I _F =5 mA, R _L =200 Ω, V _{DD} =20 V *	
		Maximum	5			3	5						
Turn-OFF time	t _{OFF}	Typical	0.1		0.2	0.1							
		Maximum	1	0.5	1	0.6	1	0.5	1	0.5			

* Turn-ON and Turn-OFF Times

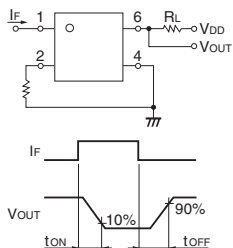

■Recommended Operating Conditions

For usage with high reliability, Recommended Operation Conditions is a measure that takes into account the derating of Absolute Maximum Ratings and Electrical Characteristics.

Each item on this list is an independent condition, so it is not simultaneously satisfy several conditions.

Item	Symbol		G3VM-21BR	G3VM-31BR	G3VM-41BR	G3VM-61BR	G3VM-61BR1	G3VM-61BR2	G3VM-101BR	G3VM-101BR1	Unit
			G3VM-21ER	G3VM-31ER	G3VM-41ER	G3VM-61ER	G3VM-61ER1	G3VM-61ER2	G3VM-101ER	G3VM-101ER1	
Load voltage (AC peak/DC)	V _{DD}	Maximum	16	24	32	48			80		V
		Minimum	5			10	5			mA	
Operating LED forward current	I _F	Typical	10			–	10				
		Maximum	25			20	25				
Continuous load current (AC peak/DC)	I _o	Maximum	4	5	3.5	2.5	3	4	2	3.5	A
		Minimum	-20	-40	-20			-40	-20	-40	
Ambient operating temperature	T _a	Maximum	65	85	65	60	65	85	65	85	°C
		Minimum									

■Spacing and Insulation

Item	Minimum	Unit
Creepage distances	7.0	mm
Clearance distances	7.0	
Internal isolation thickness	0.4	

Engineering Data

LED forward current vs. Ambient temperature

G3VM-21BR/21ER/41BR/41ER/
61BR1/61ER1/101BR/101ER

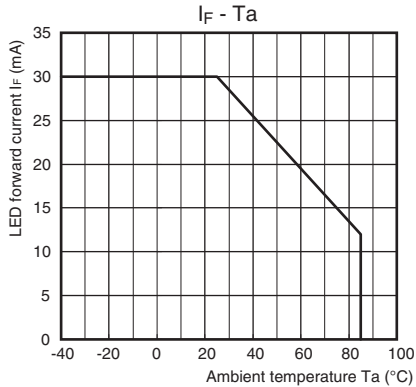

G3VM-61BR/61ER

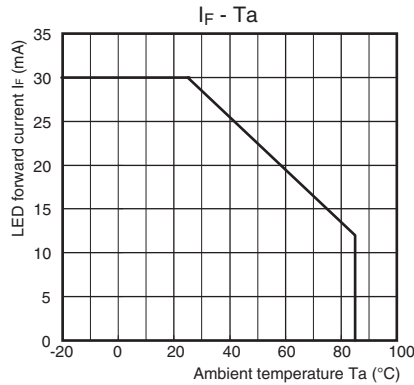

G3VM-31BR/31ER/61BR2/61ER2/
101BR1/101ER1

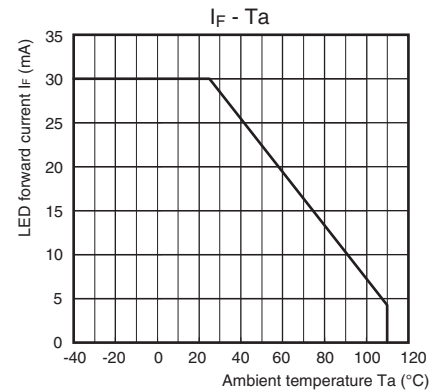

LED forward current vs. LED forward voltage

G3VM-21BR/21ER/41BR/41ER/61BR/
61ER/61BR1/61ER1/101BR/101ER

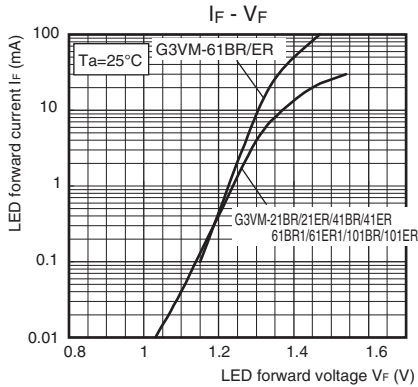

G3VM-31BR/31ER/61BR2/61ER2/
101BR1/101ER1

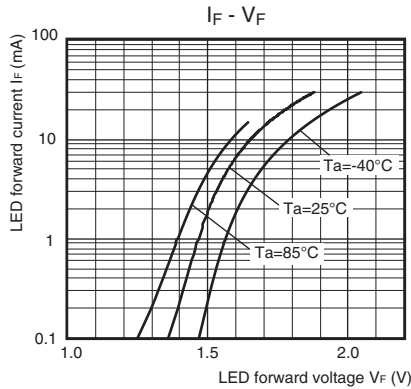

Continuous load current vs. Ambient temperature

G3VM-21BR/21ER/41BR/41ER

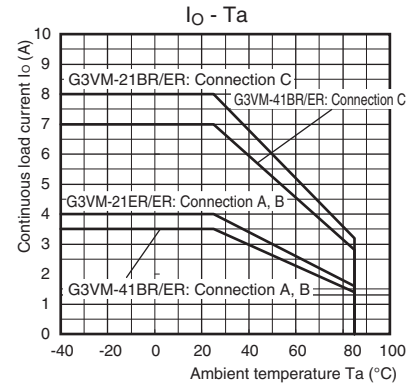

G3VM-61BR1/61ER1/101BR/101ER

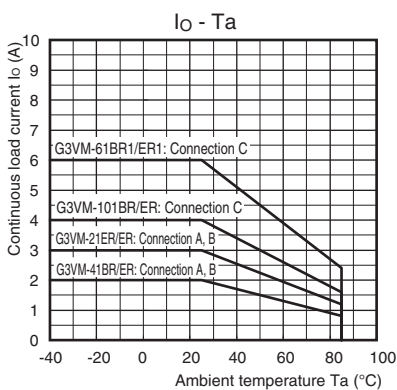

G3VM-61BR/61ER

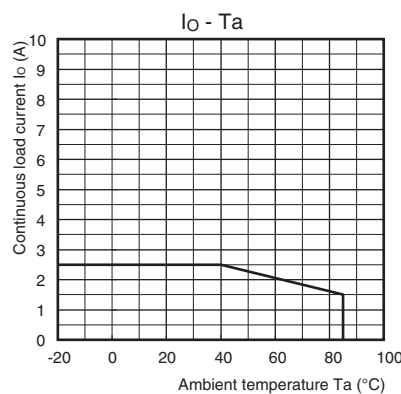

G3VM-31BR/31ER/61BR2/61ER2/
101BR1/101ER1

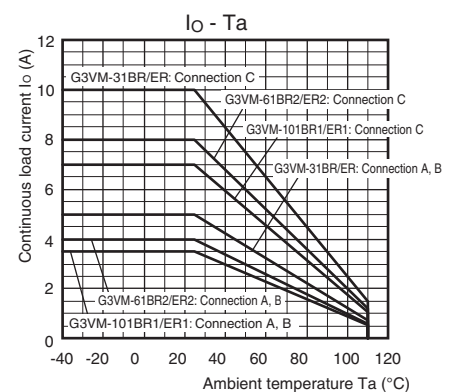

Engineering Data

Continuous load current vs. On-state voltage

G3VM-21BR/21ER/41BR/41ER/61BR/61ER/61BR1/61ER1/101BR/101ER

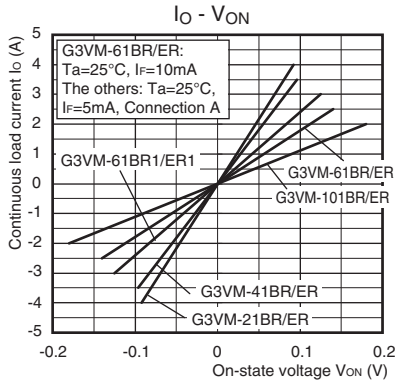

G3VM-31BR/31ER/61BR2/61ER2/101BR1/101ER1

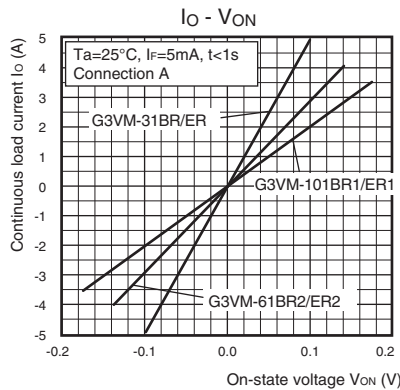

On-state resistance vs. Ambient temperature

G3VM-21BR/21ER/41BR/41ER/61BR/61ER/61BR1/61ER1/101BR/101ER

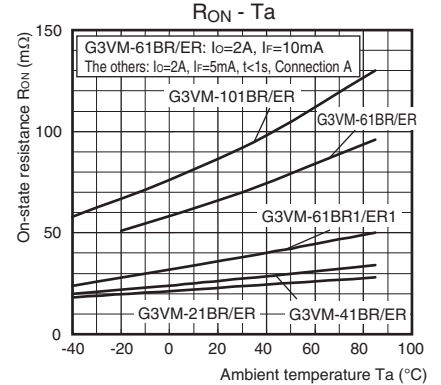

Trigger LED forward current vs. Ambient temperature

G3VM-21BR/21ER/41BR/41ER/61BR/61ER/61BR1/61ER1/101BR/101ER

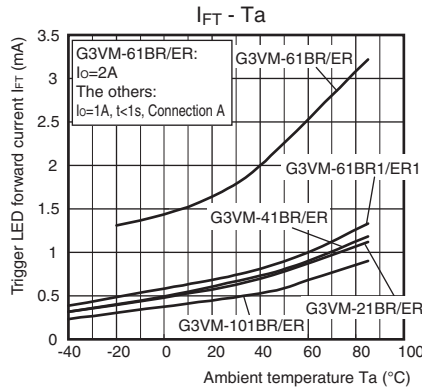

G3VM-31BR/31ER/61BR2/61ER2/101BR1/101ER1

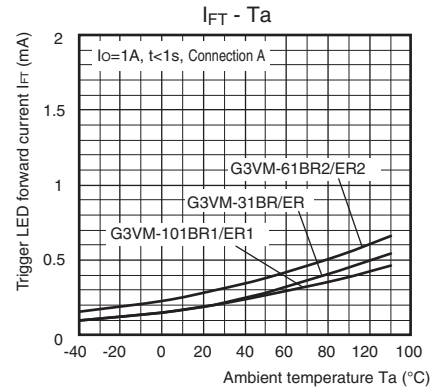

G3VM-31BR/31ER/61BR2/61ER2/101BR1/101ER1

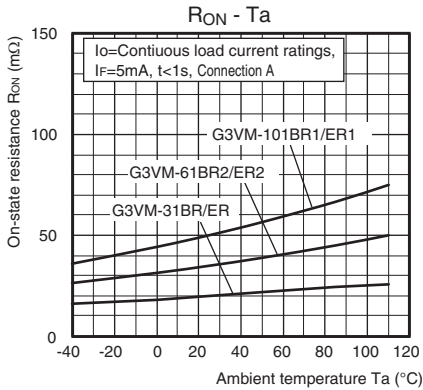

Turn ON, Turn OFF time vs. LED forward current

G3VM-21BR/21ER/41BR/41ER

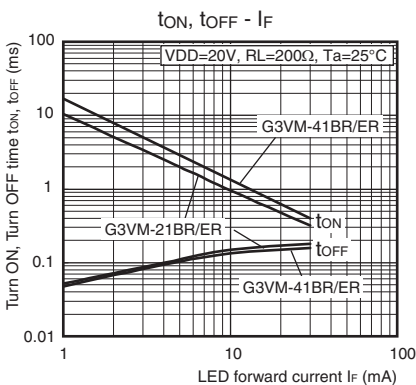

G3VM-61BR/61ER/61BR1/61ER1/101BR/101ER

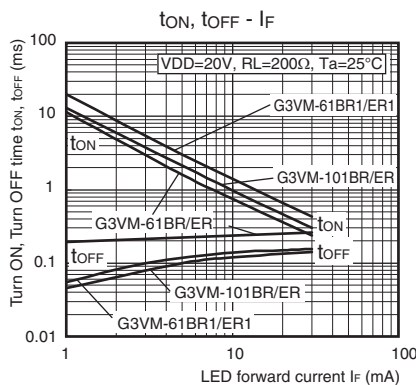

G3VM-31BR/31ER/61BR2/61ER2/101BR1/101ER1

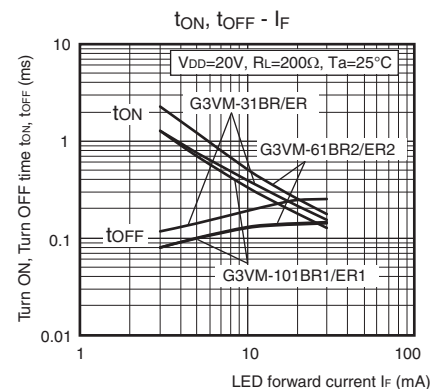

DIP G3VM-□BR□/□ER□

Engineering Data

Turn ON, Turn OFF time vs. Ambient temperature

G3VM-21BR/21ER/41BR/41ER

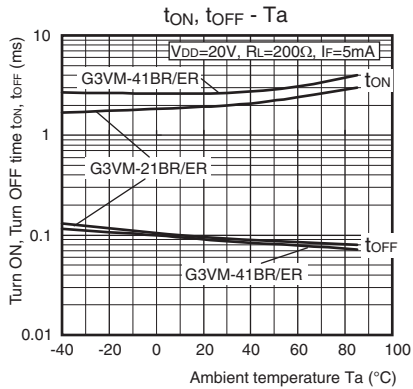

G3VM-61BR/61ER/61BR1/61ER1/101BR/101ER

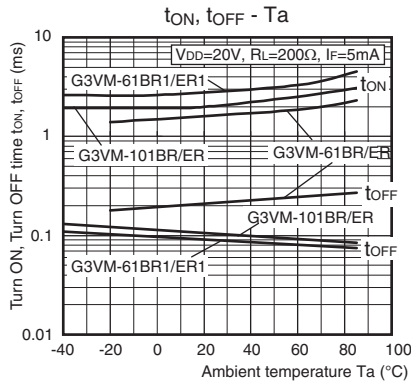

G3VM-31BR/31ER/61BR2/61ER2/101BR1/101ER1

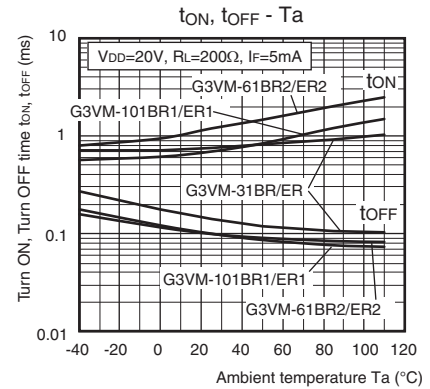

Current leakage vs. Ambient temperature

G3VM-21BR/21ER/41BR/41ER/61BR/61ER/61BR1/61ER1/101BR/101ER

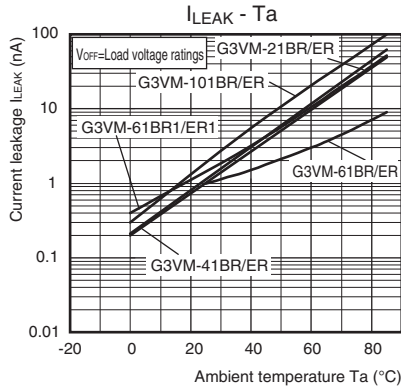

G3VM-31BR/31ER/61BR2/61ER2/101BR1/101ER1

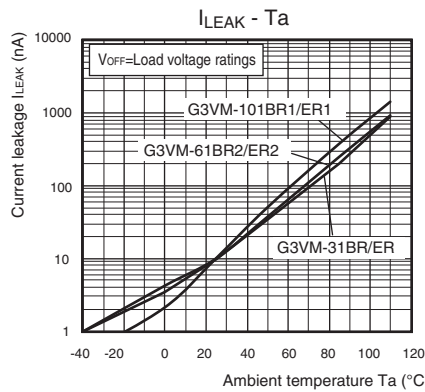

Appearance / Terminal Arrangement / Internal Connections

Appearance

DIP (Dual Inline Package)

DIP 6-pin

G3VM-21BR/ER, -31BR/ER, -41BR/ER, -61BR1/ER1, -61BR2/ER2, -101BR/ER, -101BR1/ER1

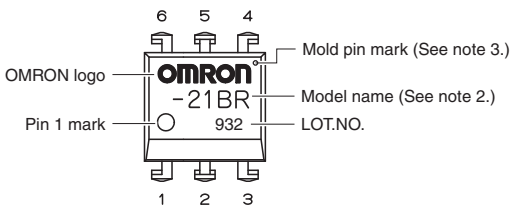

Special DIP 6-pin *
G3VM-61BR/ER

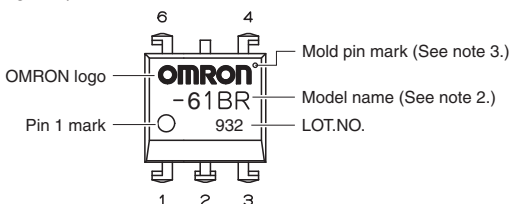

Terminal Arrangement/Internal Connections (Top View)

G3VM-21BR/ER, -31BR/ER, -41BR/ER, -61BR1/ER1, -61BR2/ER2, -101BR/ER, -101BR1/ER1

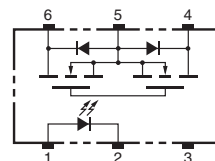

G3VM-61BR/ER

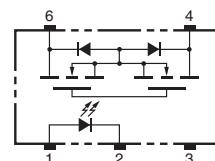

Note: 1. The actual product is marked differently from the image shown here.

Note: 2. "G3VM" does not appear in the model number on the Relay.

Note: 3. The indentation in the corner diagonally opposite from the pin 1 mark is from a pin on the mold.

* The external dimensions of the standard DIP 6-pin are the same, but the number of terminals is different.

■Dimensions (Unit: mm)

G3VM-21BR/31BR/41BR/61BR1/61BR2/
101BR/101BR1

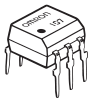

PCB Terminals

Weight: 0.4 g

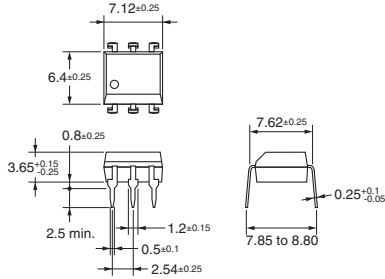

G3VM-21ER/31ER/41ER/61ER1/61ER2/
101ER/101ER1

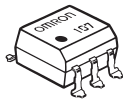

Surface-mounting Terminals

Weight: 0.4 g

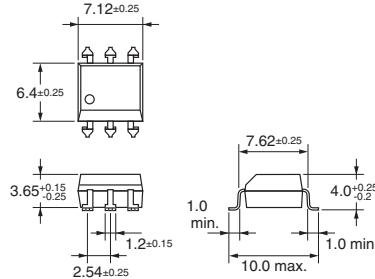

PCB Dimensions (BOTTOM VIEW)

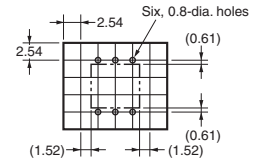

Actual Mounting Pad Dimensions (Recommended Value, Top View)

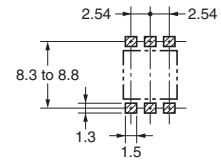

Note: The actual product is marked differently from the image shown here.

G3VM-61BR

PCB Terminals

Weight: 0.4 g

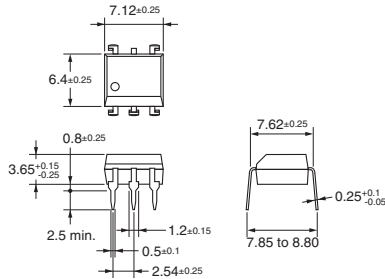

G3VM-61ER

Surface-mounting Terminals

Weight: 0.4 g

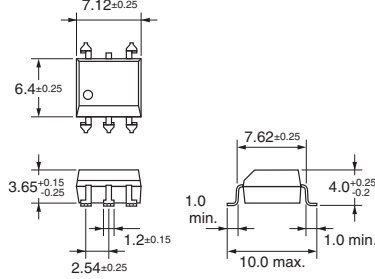
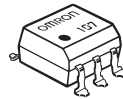

PCB Dimensions (BOTTOM VIEW)

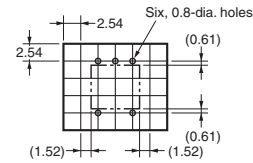

Actual Mounting Pad Dimensions (Recommended Value, Top View)

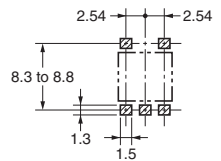

Note: The actual product is marked differently from the image shown here.

■Approved Standards

UL recognized 

Approved Standards	Contact form	File No.
UL (recognized)	1a (SPST-NO)	E80555

■Safety Precautions

- Refer to the *Common Precautions for All MOS FET Relays* for precautions that apply to all MOS FET Relays.

Please check each region's Terms & Conditions by region website.

OMRON Corporation

Electronic and Mechanical Components Company

Regional Contact

Americas

<https://www.components.omron.com/>

Asia-Pacific

<https://ecb.omron.com.sg/>

Korea

<https://www.omron-ecb.co.kr/>

Europe

<http://components.omron.eu/>

China

<https://www.ecb.omron.com.cn/>

Japan

<https://www.omron.co.jp/ecb/>