

**0.3mm Pitch
SERIES**

6841

**0.3mmピッチ ST SMT スライドロック
0.3mmPitch Vertical SMT Slide lock**

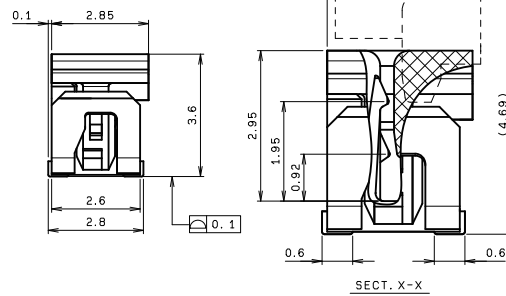
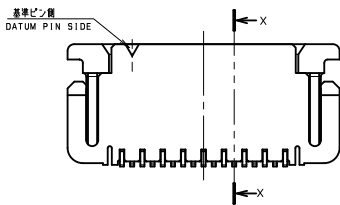
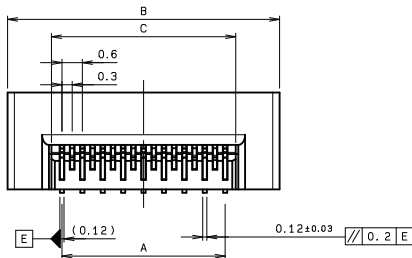

極数 NO. OF POS.	A	B	C
15	4.2	7.4	4.86
17	4.8	8.0	5.46
19	5.4	8.6	6.06
21	6.0	9.2	6.66
23	6.6	9.8	7.26
25	7.2	10.4	7.86
27	7.8	11.0	8.46
29	8.4	11.6	9.06
31	9.0	12.2	9.66
33	9.6	12.8	10.26
35	10.2	13.4	10.86
37	10.8	14.0	11.46
39	11.4	14.6	12.06
41	12.0	15.2	12.66
43	12.6	15.8	13.26
45	13.2	16.4	13.86
47	13.8	17.0	14.46
49	14.4	17.6	15.06
51	15.0	18.2	15.66

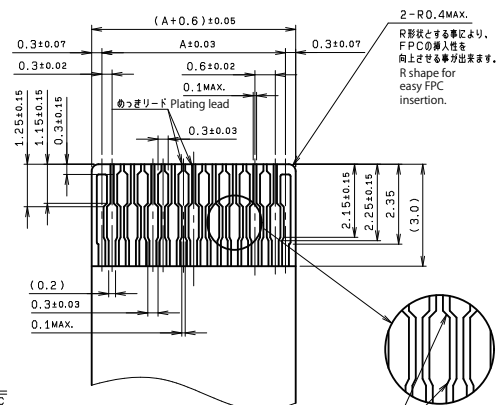
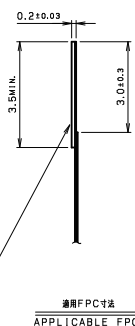
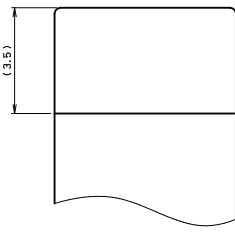
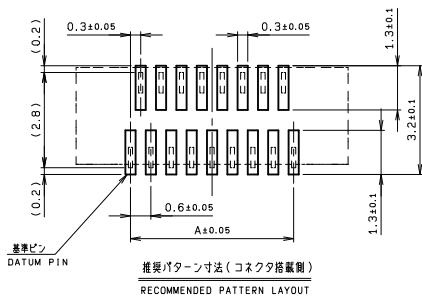

テーパ部をオーバーラップさせる事により、
屈曲時の断線が発生しにくくなります。
For prevention against an open
circuit in being bent, the tapered
areas shall be laid as indicated.

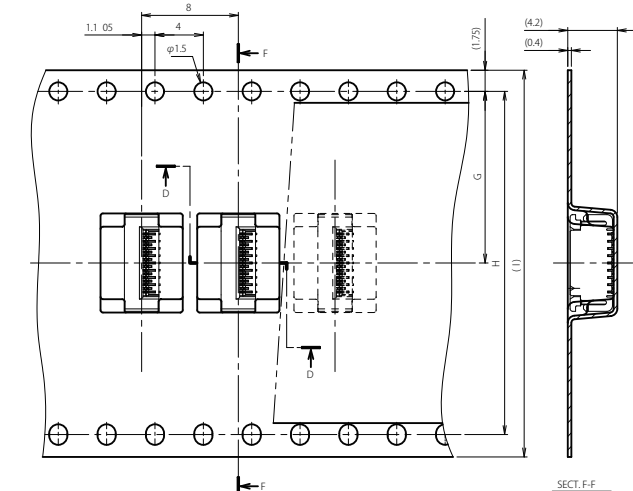

極数 NO. OF POS.	G	H	I
15	7.5	—	16.0
17	7.5	—	16.0
19	11.5	—	24.0
21	—	—	—
23	—	—	—
25	—	—	—
27	—	—	—
29	—	—	—
31	—	—	—
33	—	—	—
35	—	—	—
37	—	—	—
39	—	—	—
41	—	—	—
43	—	—	—
45	11.5	—	24.0
47	14.2	28.4	32.0
49	14.2	28.4	32.0
51	14.2	28.4	32.0

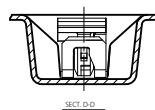

注文コード ORDERING CODE
04 6841 0XX X00 846+

RoHS 対応品
RoHS Compliant Product

金めっき Au plated

エンボス仕様 Tape&Reel

1: 標準品 (メカチャック対応) Standard (Able to Mechanical chucking)

0: 吸着専用 Vacuum only type

極数 NUMBER OF POSITIONS

生産対応可能極数については、営業部にご確認願います。

Feel free to contact our sales department for available numbers of positions.

梱包数量 2000個/リール
PACKING QUANTITY : 2000 /Reel