

## GaAs PHEMT MMIC MEDIUM POWER AMPLIFIER, 5 - 18 GHz

### Typical Applications

The HMC451LP3(E) is ideal for:

- Microwave Radio & VSAT
- Military & Space
- Test Equipment & Sensors
- Fiber Optics
- LO Driver for HMC Mixers

### Features

- Gain: 18 dB
- Saturated Power: +21 dBm @ 18% PAE
- Output IP3: +28 dBm
- Single Supply: +5V @ 120 mA
- 50 Ohm Matched Input/Output
- 16 Lead 3x3mm SMT Package: 9mm<sup>2</sup>

### Functional Diagram

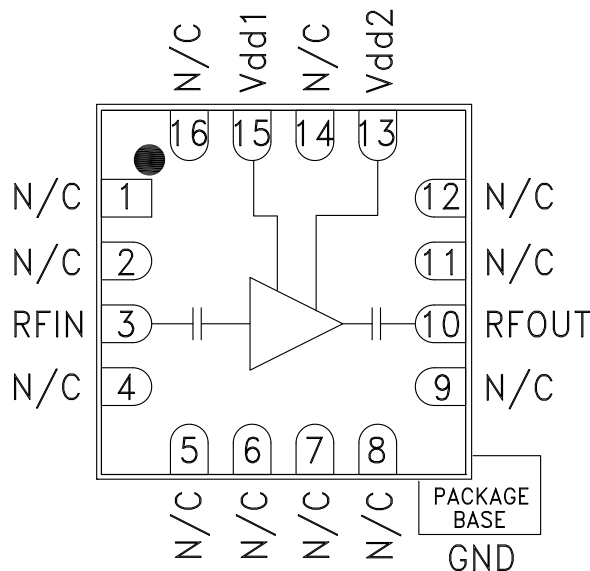

### General Description

The HMC451LP3(E) is an efficient GaAs PHEMT MMIC Medium Power Amplifier housed in a leadless RoHS compliant SMT package. Operating between 5 and 18 GHz, the amplifier provides 18 dB of gain, +21 dBm of saturated power and 18% PAE from a single +5V supply. This 50 Ohm matched amplifier does not require any external components and the RF I/O's are DC blocked, making it an ideal linear gain block or LO driver for HMC mixers. The HMC451LP3(E) eliminates the need for wire bonding, and allows the use of surface mount manufacturing techniques.

### Electrical Specifications, $T_A = +25^\circ \text{C}$ , $V_{dd1} = V_{dd2} = +5\text{V}$

Parameter	Min.	Typ.	Max.	Min.	Typ.	Max.	Units
Frequency Range	5 - 16		16 - 18				GHz
Gain	15	18		12.5	16		dB
Gain Variation Over Temperature		0.02	0.03		0.02	0.03	dB/°C
Input Return Loss		13			13		dB
Output Return Loss		12			8		dB
Output Power for 1 dB Compression (P1dB)	16.5	19.5		16	19		dBm
Saturated Output Power (Psat)		21			20		dBm
Output Third Order Intercept (IP3)		28			25		dBm
Noise Figure		7			7		dB
Supply Current (I <sub>dd</sub> )		120	150		120	150	mA

**GaAs PHEMT MMIC MEDIUM POWER AMPLIFIER, 5 - 18 GHz**

**Broadband Gain & Return Loss**

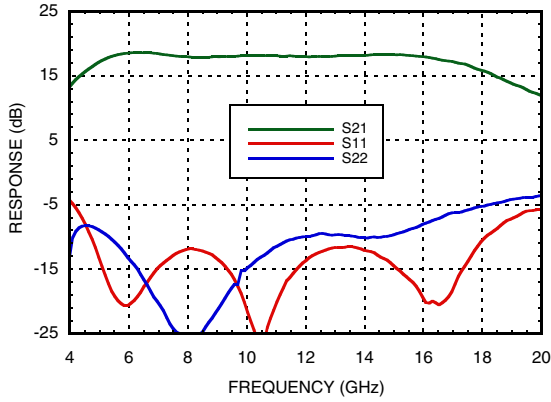

**Gain vs. Temperature**

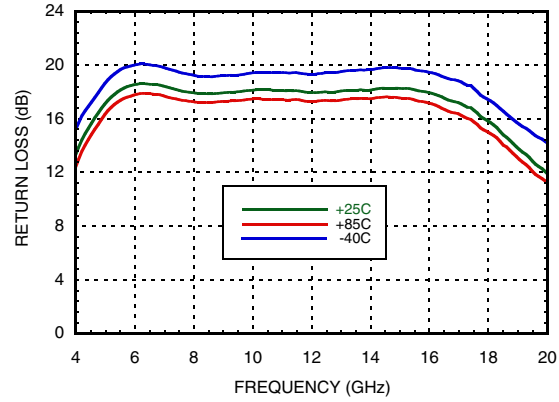

**Input Return Loss vs. Temperature**

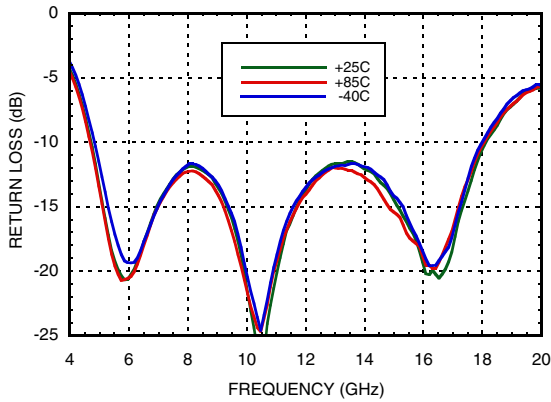

**Output Return Loss vs. Temperature**

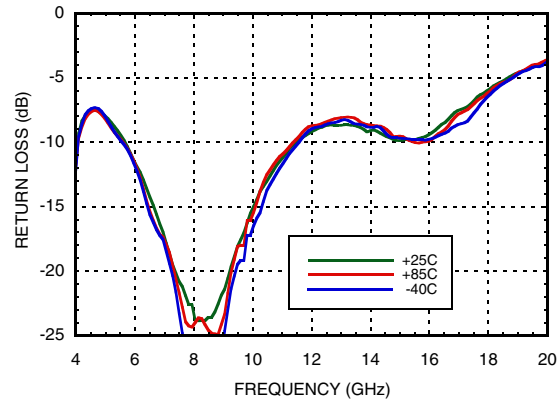

**P1dB vs. Temperature**

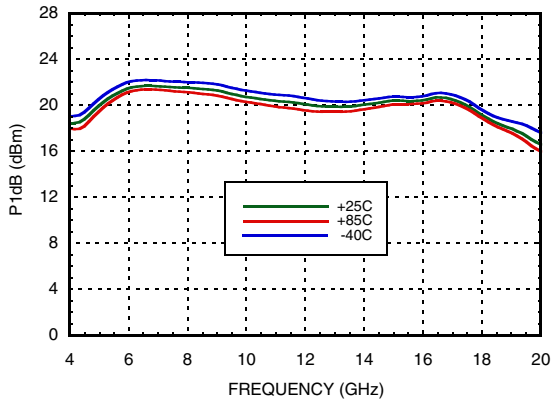

**Psat vs. Temperature**

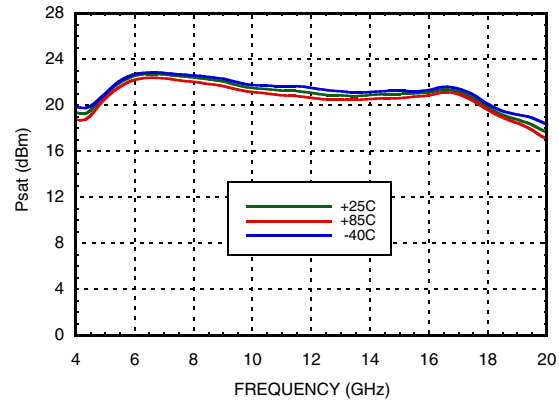

**GaAs PHEMT MMIC MEDIUM POWER AMPLIFIER, 5 - 18 GHz**

**Power Compression @ 10 GHz**

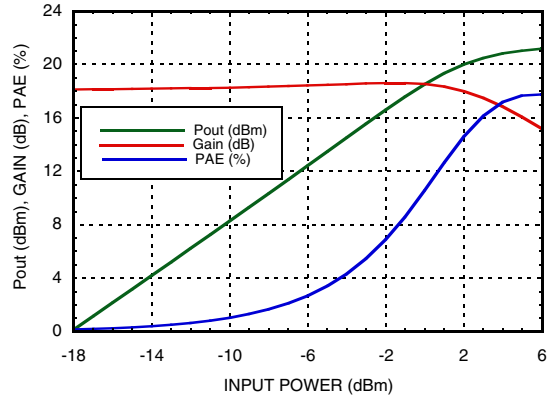

**Power Compression @ 17 GHz**

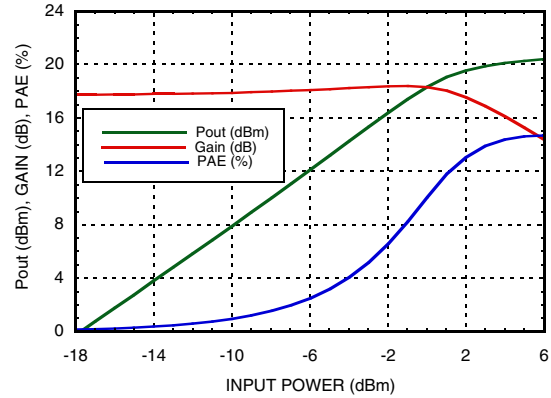

**Output IP3 vs. Temperature**

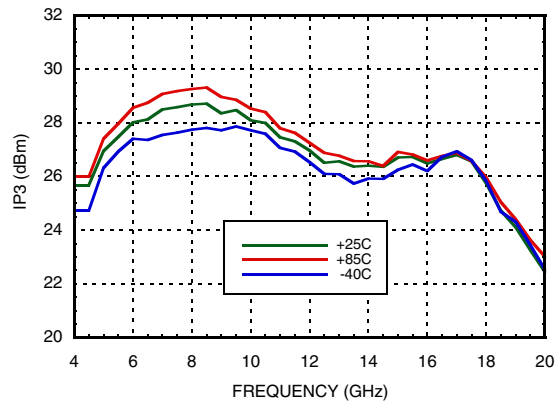

**Noise Figure vs. Temperature**

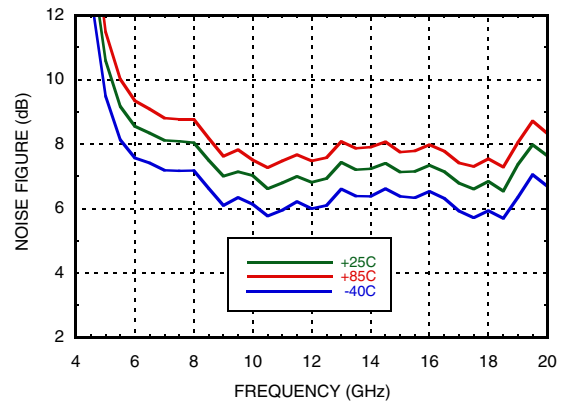

**Gain, P1dB & PSAT vs. Supply Voltage @ 11 GHz**

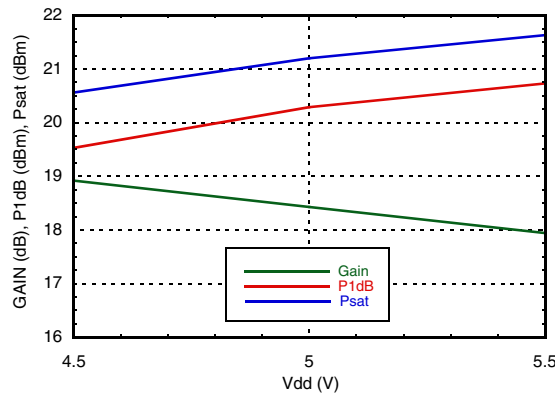

**Reverse Isolation vs. Temperature**

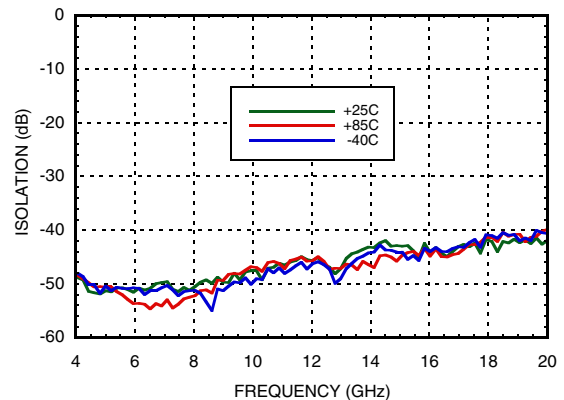

## GaAs PHEMT MMIC MEDIUM POWER AMPLIFIER, 5 - 18 GHz

### Absolute Maximum Ratings

Drain Bias Voltage ( $V_{dd_1} = V_{dd_2}$ )	+5.5V
RF Input Power (RFIN)( $V_{dd} = +5V_{dc}$ )	+10 dBm
Channel Temperature	175 °C
Continuous $P_{diss}$ (T = 85 °C) (derate 12.8 mW/°C above 85 °C)	1.15 W
Thermal Resistance (channel to ground paddle)	78 °C/W
Storage Temperature	-65 to +150 °C
Operating Temperature	-40 to +85 °C
ESD Sensitivity (HBM)	Class 1A, passed 250V

### Typical Supply Current vs. $V_{dd_1} = V_{dd_2}$

$V_{dd_1} = V_{dd_2}$ (V)	$I_{dd_1} + I_{dd_2}$ (mA)
+4.5	120
+5.0	122
+5.5	124

Note: Amplifier will operate over full voltage range shown above



**ELECTROSTATIC SENSITIVE DEVICE  
OBSERVE HANDLING PRECAUTIONS**

**GaAs PHEMT MMIC MEDIUM  
POWER AMPLIFIER, 5 - 18 GHz**

**Outline Drawing - HMC451LP3**

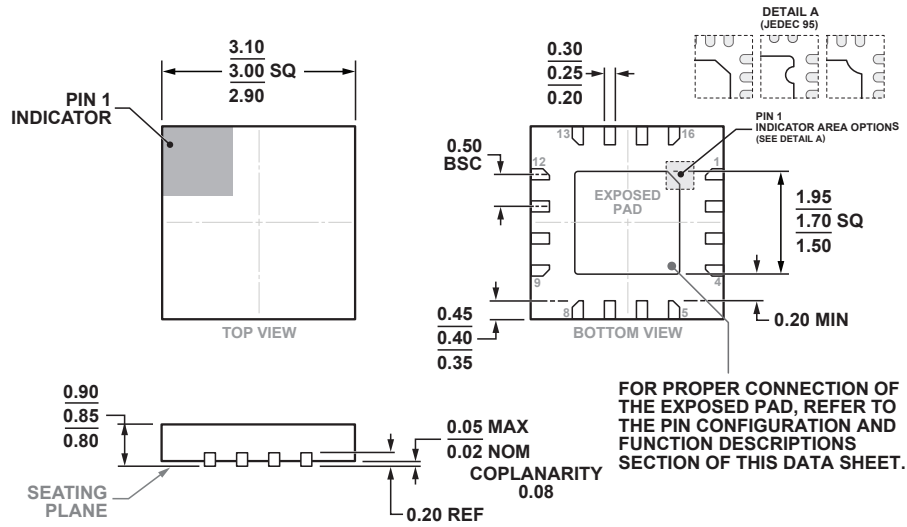

COMPLIANT WITH JEDEC STANDARDS MO-220-VEED-4.

16-Lead Lead Frame chip Scale Package [LFCSP]  
3 mm x 3 mm Body and 0.85 mm Package Height  
(HCP-16-1)

Dimensions shown in millimeters.

PKG-000003

03-15-2017-B

## GaAs PHEMT MMIC MEDIUM POWER AMPLIFIER, 5 - 18 GHz

### Outline Drawing - HMC451LP3E

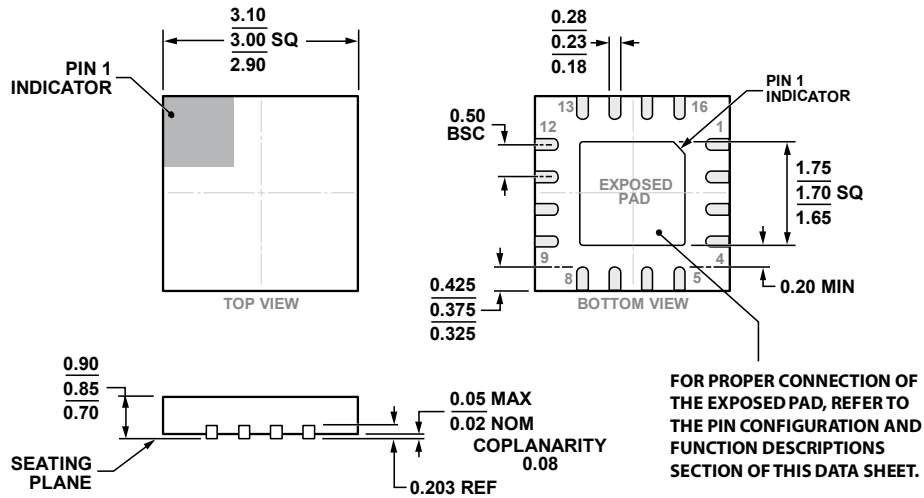

16-Lead Lead Frame chip Scale Package [LFCSP]  
 3 mm × 3 mm Body and 0.85 mm Package Height  
 (HCP-16-3)  
 Dimensions shown in millimeters.

### Package Information

Part Number	Package Body Material	Lead Finish	MSL Rating	Package Marking <sup>[3]</sup>
HMC451LP3	Low Stress Injection Molded Plastic	Sn/Pb Solder	MSL1 <sup>[1]</sup>	H451 XXXX
HMC451LP3E	RoHS-compliant Low Stress Injection Molded Plastic	100% matte Sn	MSL1 <sup>[2]</sup>	451 XXXX

[1] Max peak reflow temperature of 235 °C  
 [2] Max peak reflow temperature of 260 °C  
 [3] 4-Digit lot number XXXX

## GaAs PHEMT MMIC MEDIUM POWER AMPLIFIER, 5 - 18 GHz

### Pin Descriptions

Pin Number	Function	Description	Interface Schematic
1, 2, 4 - 9, 11, 12, 14, 16	N/C	This pin may be connected to RF/DC ground. Performance will not be affected.	
3	RFIN	This pin is AC coupled and matched to 50 Ohms.	RFIN
10	RFOUT	This pin is AC coupled and matched to 50 Ohms.	RFOUT
13	Vdd2	Power Supply Voltage for the amplifier. External bypass capacitors of 100 pF, 1,000 pF and 2.2 μF are required.	
15	Vdd1	Power Supply Voltage for the amplifier. External bypass capacitors of 100 pF, 1,000 pF and 2.2 μF are required.	
	GND	Package bottom must be connected to RF/DC ground.	

### Application Circuit

Component	Value
C1, C2	100 pF
C3, C4	1,000 pF
C5, C6	2.2 μF

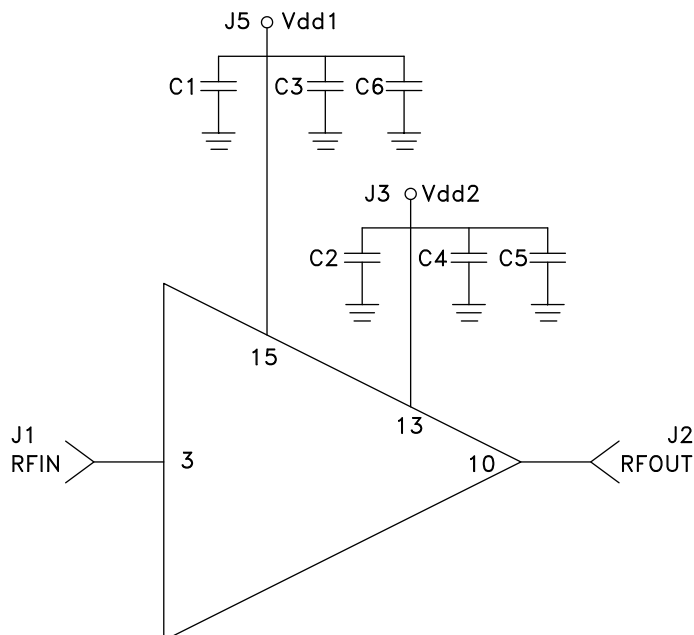

### Evaluation PCB

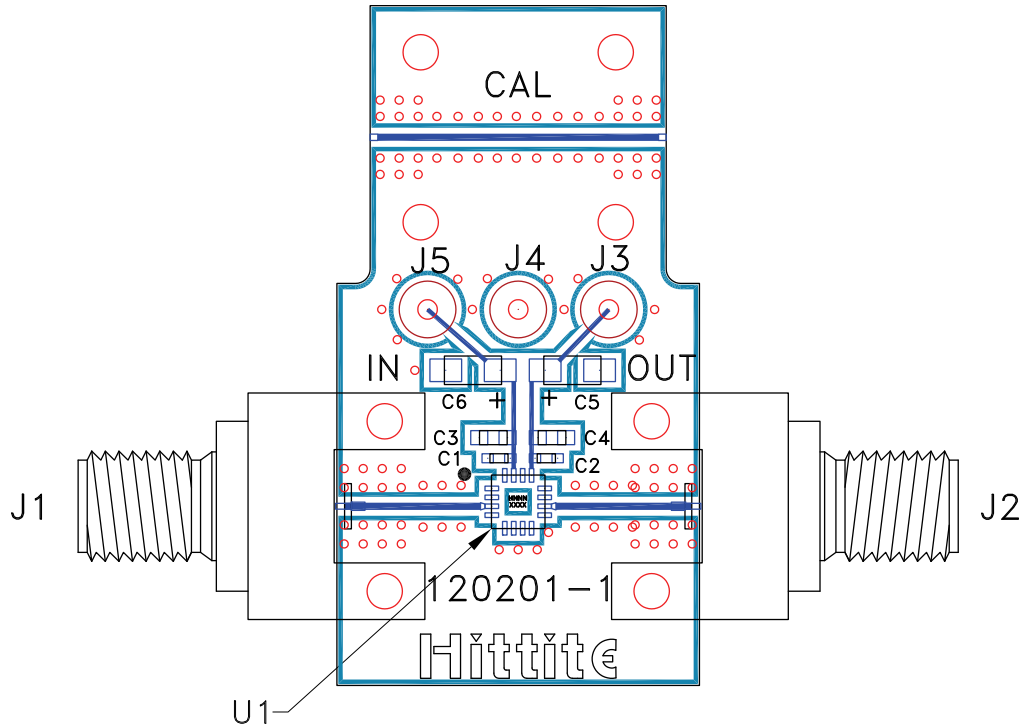

### List of Materials for Evaluation PCB 120202 [1]

Item	Description
J1 - J2	PCB Mount SMA Connector
J3 - J5	DC Pin
C1, C2	100 pF Capacitor, 0402 Pkg.
C3, C4	1000 pF Capacitor, 0603 Pkg.
C5, C6	2.2 μF Capacitor, Tantalum
U1	HMC451LP3(E) Amplifier
PCB [2]	120201 Evaluation PCB

[1] Reference this number when ordering complete evaluation PCB

[2] Circuit Board Material: Arlon 25FR

The circuit board used in the application should use RF circuit design techniques. Signal lines should have 50 Ohm impedance while the package ground leads and exposed paddle should be connected directly to the ground plane similar to that shown. A sufficient number of via holes should be used to connect the top and bottom ground planes. The evaluation board should be mounted to an appropriate heat sink. The evaluation circuit board shown is available from Analog Devices, upon request.