

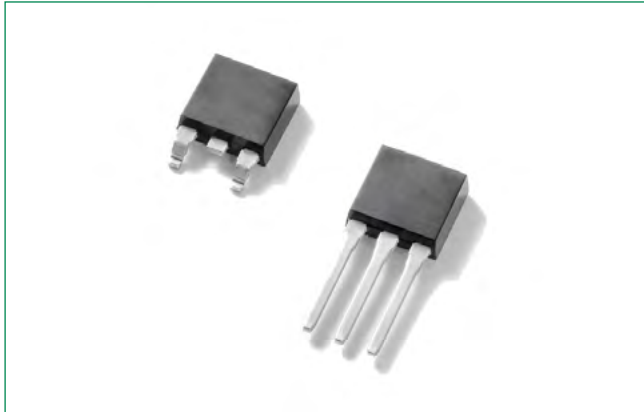

MCR70xA Series

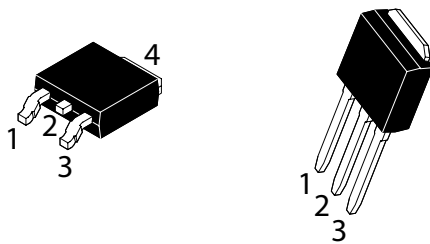

Pin Out



Description

The MCR70xA Series is a PNP component designed for high volume, low cost consumer applications such as temperature, light and speed control; process and remote control; and warning systems where reliability of operation is critical.

Features

- Small Size
- Passivated Die Surface for Reliability and Uniformity
- Low Level Triggering and Holding Characteristics
- Recommend Electrical Replacement for C106
- Surface Mount Package – Case 369C
- To Obtain “DPAK” in Straight Lead Version (Shipped in Sleeves): Add ‘1’ Suffix to Component Number, i.e., MCR706A1
- UL Recognized compound meeting flammability rating V-0.
- ESD Ratings: Human Body Model, 3B > 8000 V Machine Model, C > 400 V
- Pb-Free Packages are Available

Additional Information



Resources

Functional Diagram

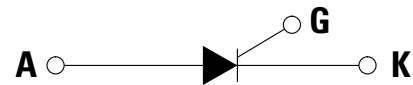

Maximum Ratings ($T_J = 25^\circ\text{C}$ unless otherwise noted)

Rating	Symbol	Value	Unit
Peak Repetitive Off-State Voltage (Note 1) ($T_C = -40$ to $+110^\circ\text{C}$, Sine Wave, 50 to 60 Hz, $R_{GK} = 1\text{ k}\Omega$)	MCR703A MCR706A MCR708A V_{DRM} V_{RRM}	100 400 600	V
Peak Non-Repetitive Off-State Voltage (180° Conduction Angles; $T_C = 85^\circ\text{C}$)	MCR703A MCR706A MCR708A V_{DSM}	150 450 650	V
On-State RMS Current (180° Conduction Angles; $T_C = 90^\circ\text{C}$)	$I_{T(RMS)}$	4.0	A
Average On-State Current (180° Conduction Angles)	$T_C = -40$ to $+90^\circ\text{C}$ $T_C = +100^\circ\text{C}$ $I_{T(AV)}$	2.6 1.6	A
Non-Repetitive Surge Current (1/2 Cycle, Sine Wave 60 Hz, $T_J = 110^\circ\text{C}$) (1/2 Cycle, Sine Wave 1.5 ms, $T_J = 110^\circ\text{C}$)	I_{TSM}	25 35	A
Circuit Fusing Consideration ($t = 8.3\text{ ms}$)	I^2t	2.6	A ² sec
Forward Peak Gate Power (Pulse Width $\leq 1.0\text{ }\mu\text{sec}$, $T_C = 90^\circ\text{C}$)	P_{GM}	0.5	W
Forward Peak Gate Current (Pulse Width $\leq 1.0\text{ }\mu\text{sec}$, $T_C = 90^\circ\text{C}$)	I_{GM}	0.2	A
Forward Average Gate Power ($t = 8.3\text{ ms}$, $T_C = 90^\circ\text{C}$)	$P_{G(AV)}$	0.1	W
Operating Junction Temperature Range	T_J	-40 to +110	$^\circ\text{C}$
Storage Temperature Range	T_{STG}	-40 to +150	$^\circ\text{C}$

Stresses exceeding Maximum Ratings may damage the Component. Maximum Ratings are stress ratings only. Functional operation above the Recommended Operating Conditions is not implied. Extended exposure to stresses above the Recommended Operating Conditions may affect Component reliability.

1. V_{DRM} and V_{RRM} for all types can be applied on a continuous basis. Ratings apply for zero or negative gate voltage; however, positive gate voltage shall not be applied concurrent with negative potential on the anode. Blocking voltages shall not be tested with a constant current source such that the voltage ratings of the Components are exceeded.

Thermal Characteristics*

Rating	Symbol	Value	Unit
Thermal Resistance, Junction-to-Case	$R_{\theta JC}$	3.0	$^\circ\text{C}/\text{W}$
Thermal Resistance, Junction-to-Ambient (Note 2)	$R_{\theta JA}$	80	
Maximum Lead Temperature for Soldering Purposes 1/8" from Case for 10 Seconds	T_L	260	$^\circ\text{C}$

2. Case 369C when surface mounted on minimum pad sizes recommended.

Electrical Characteristics - OFF ($T_J = 25^\circ\text{C}$ unless otherwise noted)

Characteristic	Symbol	Min	Typ	Max	Unit
Peak Repetitive Forward or Reverse Blocking Current ($V_{AK} = \text{Rated } V_{DRM}$ or V_{RRM} ; $R_{GK} = 1\text{ k}\Omega$)	$T_J = 25^\circ\text{C}$ $T_J = 110^\circ\text{C}$ I_{DRM} I_{RRM}	-	-	10 200	μA

Electrical Characteristics - ON ($T_J = 25^\circ\text{C}$ unless otherwise noted)

Characteristic	Symbol	Min	Typ	Max	Unit
Peak Forward "On" Voltage ($I_{TM} = 8.2\text{ A}$ Peak, Pulse Width = 1 to 2 ms, 2% Duty Cycle)	V_{TM}	-	-	2.2	V
Gate Trigger Current (Continuous dc) (Note 3) ($V_{AK} = 12\text{ V}$; $R_L = 24\text{ }\Omega$)	$T_J = 25^\circ\text{C}$ $T_J = -40^\circ\text{C}$ I_{GT}	-	25	75 300	μA
Gate Trigger Voltage (Continuous dc) (Note 3) ($V_{AK} = 12\text{ V}$; $R_L = 24\text{ }\Omega$)	$T_J = 25^\circ\text{C}$ $T_J = -40^\circ\text{C}$ V_{GT}	-	-	0.8 1.0	V
Gate Non-Trigger Voltage (Note 3) ($V_{AK} = 12\text{ Vdc}$; $R_L = 100\text{ }\Omega$; $T_C = 110^\circ$)	V_{GD}	0.2	-	-	V
Holding Current ($V_{AK} = 12\text{ Vdc}$, $R_{GK} = 1\text{ k}\Omega$) $T_C = 25^\circ\text{C}$ (Initiating Current = 20 mA) $T_C = -40^\circ\text{C}$	I_H	-	-	5.0 10	mA
Peak Reverse Gate Blocking Voltage ($I_{GR} = 10\text{ }\mu\text{A}$)	V_{RGM}	10	12.5	18	V
Peak Reverse Gate Blocking Current ($V_{GR} = 10\text{ V}$)	I_{RGM}	-	-	1.2	μA
Total Turn-On Time (Source Voltage = 12 V, $R_S = 6\text{ k}\Omega$) ($I_{TM} = 8.2\text{ A}$, $I_{GT} = 2\text{ mA}$, Rated V_{DRM}) (Rise Time = 20 ns, Pulse Width = 10 μs)	t_{GT}	-	2.0	-	μs

Dynamic Characteristics*

Characteristic	Symbol	Min	Typ	Max	Unit
Critical Rate of Rise of Off-State Voltage ($V_D = \text{Rated } V_{DRM}$, $R_{GK} = 1 \text{ k}\Omega$, Exponential Waveform, Gate Open, $T_c = 110^\circ\text{C}$)	dv/dt	-	10	-	V/ μs
Repetitive Critical Rate of Rise of On-State Current (Cf = 60 Hz, $I_{PK} = 30 \text{ A}$, PW = 100 μs , diG/dt = 1 A/ μs)	di/dt	-	-	100	A/ μs

3. RGK current not included in measurement.

Voltage Current Characteristic of SCR

Symbol	Parameter
V_{DRM}	Peak Repetitive Forward Off State Voltage
I_{DRM}	Peak Forward Blocking Current
V_{RRM}	Peak Repetitive Reverse Off State Voltage
I_{RRM}	Peak Reverse Blocking Current
V_{TM}	Maximum On State Voltage
I_H	Holding Current

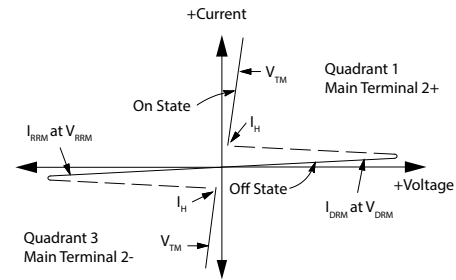

Figure 1. RMS Current Derating

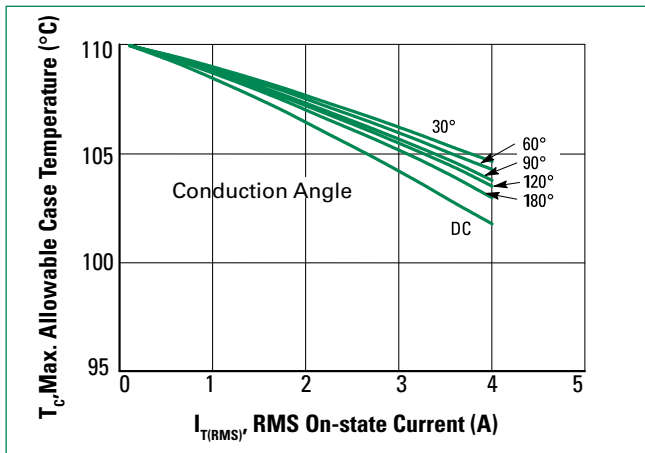

Figure 2. On-State Power Dissipation

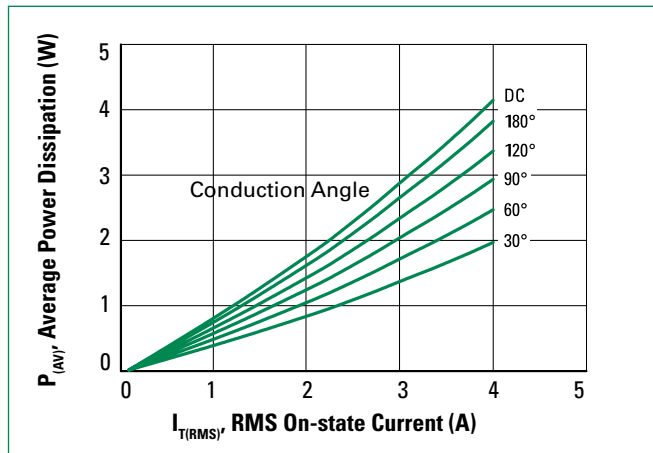

Figure 3. On-State Characteristics

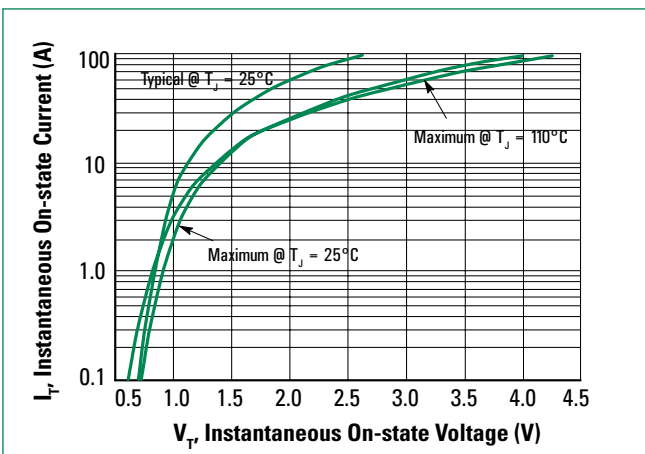

Figure 4. Transient Thermal Response

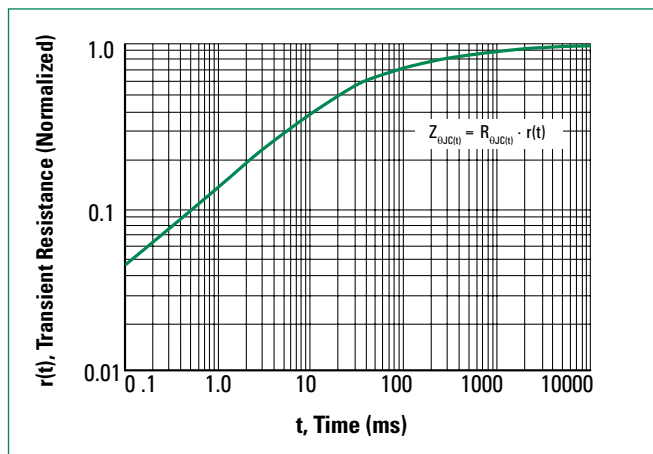

Figure 5. Typical Gate Trigger Current vs Junction Temperature

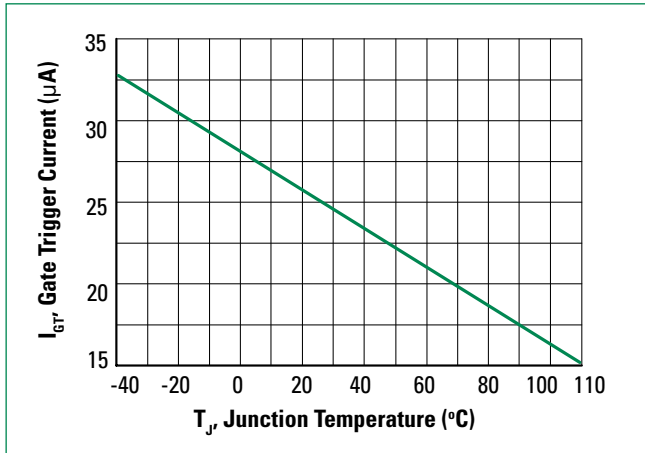

Figure 6. Typical Gate Trigger Voltage vs Junction Temperature

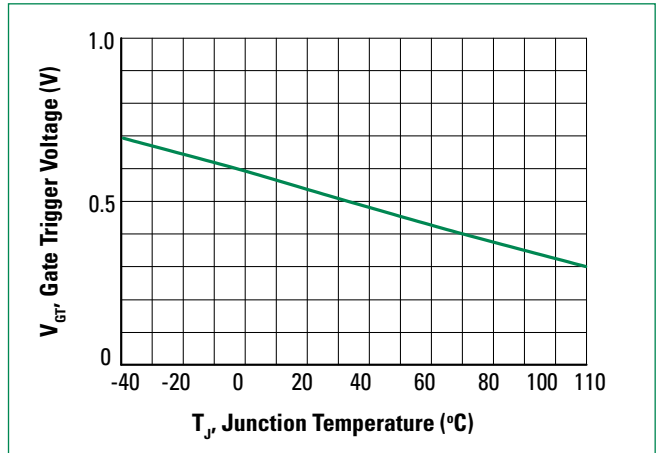

Figure 7. Typical Holding Current vs Junction Temperature

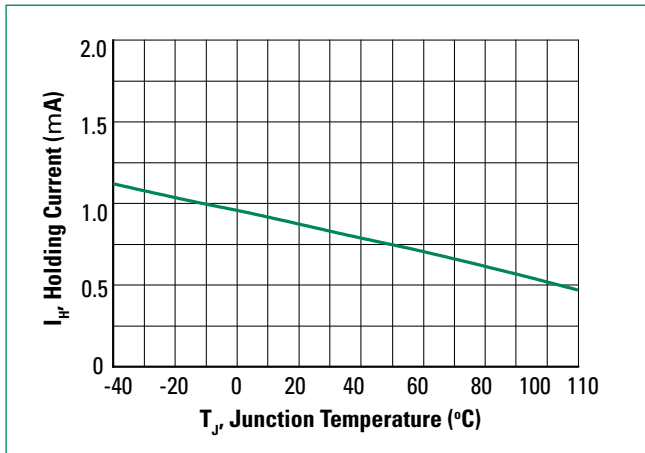
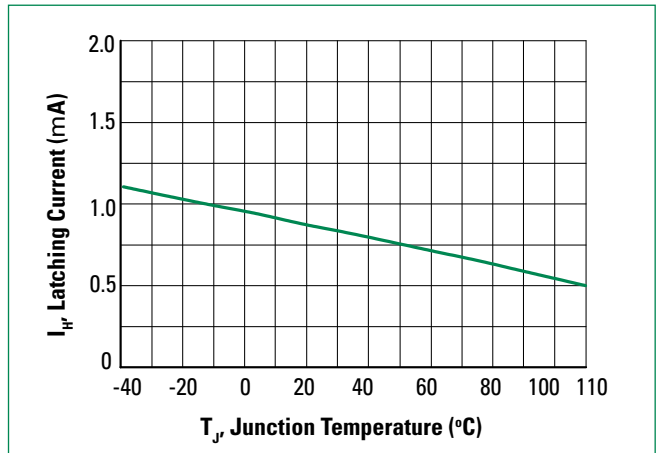
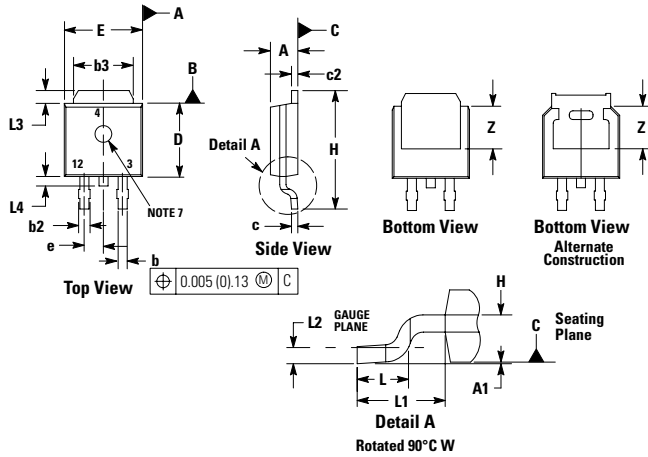

Figure 8. Typical Latching Current vs Junction Temperature



Dimensions



Soldering Footprint

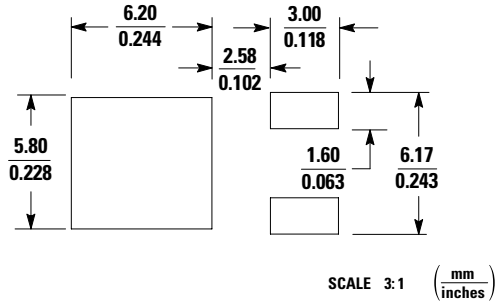

Dim	Inches		Millimeters	
	Min	Max	Min	Max
A	0.087	0.094	2.20	2.40
A1	0.000	0.005	0.00	0.12
b	0.022	0.030	0.55	0.75
b2	0.026	0.033	0.65	0.85
b3	0.209	0.217	5.30	5.50
c	0.019	0.023	0.49	0.59
c2	0.019	0.023	0.49	0.59
D	0.213	0.224	5.40	5.70
E	0.252	0.260	6.40	6.60
e	0.091		2.30	
H	0.374	0.406	9.50	10.30
L	0.058	0.070	1.47	1.78
L1	0.114		2.90	
L2	0.019	0.023	0.49	0.59
L3	0.053	0.065	1.35	1.65
L4	0.028	0.039	0.70	1.00
Z	0.154	-	3.90	-

1. Dimensioning and Tolerancing per ANSI Y14.5M, 1982.
2. Controlling Dimension: Inch.

STYLE 6:
PIN 1. GATE
2. ANODE
3. CATHODE
4. ANODE

Dimensions

DPAK-3
Case 369D-01
Issue B

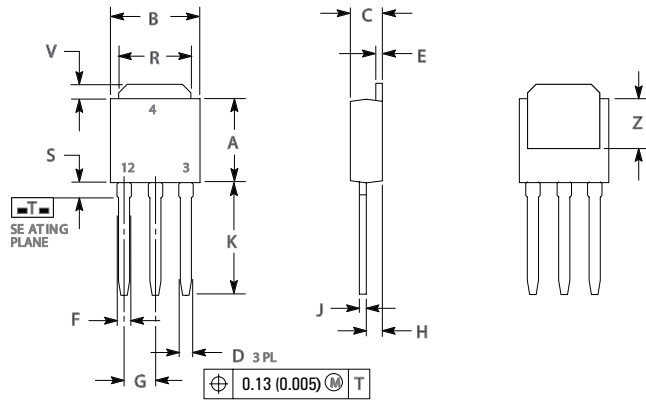

Dim	Inches		Millimeters	
	Min	Max	Min	Max
A	0.213	0.224	5.40	5.70
B	0.252	0.260	6.40	6.60
C	0.087	0.094	2.20	2.40
D	0.024	0.030	0.60	0.75
E	0.022	0.026	0.55	0.65
F	0.031	0.039	0.78	0.98
G	0.091		2.30	
H	0.046	0.050	1.18	1.28
J	0.019	0.023	0.49	0.59
K	0.291	0.315	7.40	8.00
R	0.209	0.217	5.30	5.50
S	0.063		1.60	
V	0.053	0.065	1.35	1.65
Z	0.150		3.80	

1. Dimensioning and Tolerancing per ANSI Y14.5M, 1982.
2. Controlling Dimension: Inch.

STYLE 6:
PIN 1: GATE
2: ANODE
3: CATHODE
4: ANODE

Part Marking System

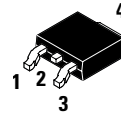

DPAK
Case 369C
Style 6

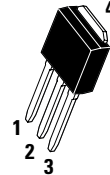
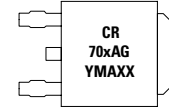

DPAK-3
Case 369D
Style 6

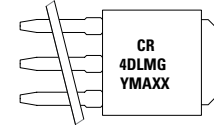

x =D, M, or N
Y =Year
M =Month
A =Assembly Site
XX =Lot Serial Code
G =Pb-Free Package

Pin Assignment	
1	Gate
2	Anode
3	Cathode
4	Anode

Ordering Information

Component	Package		Shipping
MCR703AT4	DPAK	369C	2500 Tape & Reel
MCR703AT4G		369C (Pb-Free)	
MCR706AT4		369C	
MCR706AT4G		369C (Pb-Free)	
MCR708A	DPAK-3	369C	4000 Units/ Box
MCR708AG		369C (Pb-Free)	
MCR708A1		369D	
MCR708A1G		369D (Pb-Free)	
MCR708AT4	DPAK	369C	2500 Tape & Reel
MCR708AT4G		369C (Pb-Free)	