

## LOW DROPOUT VOLTAGE REGULATOR

### ■ GENERAL DESCRIPTION

The NJM2888 is a low dropout voltage regulator with ON/OFF control.

Advanced Bipolar technology achieves low noise, high ripple rejection and low quiescent current.

Small packaging, 1.0 $\mu$ F small decoupling capacitor and built-in noise bypass capacitor less make the NJM2888 suitable for space conscious applications.

### ■ PACKAGE OUTLINE

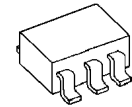

NJM2888F

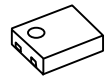

NJM2888KF1

### ■ FEATURES

- High Ripple Rejection      75dB typ. (f=1kHz, Vo=3V Version)
- Low Output Noise Voltage   Vno=45 $\mu$ Vrms typ.
- Output capacitor with 1.0 $\mu$ F ceramic capacitor (Vo $\geq$ 2.7V)
- Output Current                Io(max.)=300mA
- High Precision Output        Vo $\pm$ 1.0%
- Low Dropout Voltage         0.10V typ. (Io=100mA)
- ON/OFF Control
- Internal Thermal Overload Protection
- Internal Short Circuit Current Limit
- Bipolar Technology
- Package Outline                SOT-23-5(NJM2888F) / ESON4(NJM2888KF1)

### ■ PIN CONFIGURATION

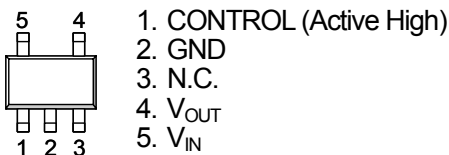

NJM2888F

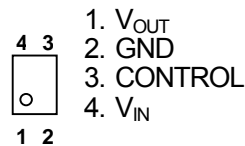

NJM2888KF1

### ■ EQUIVALENT CIRCUIT

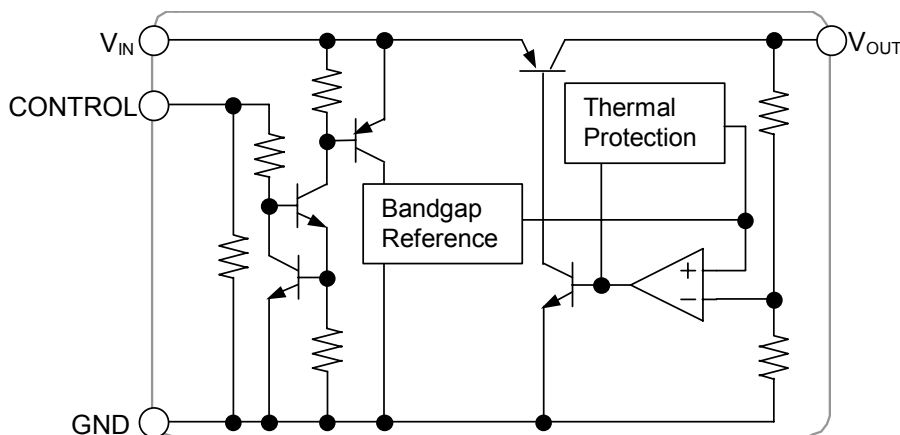

# NJM2888

## ■ OUTPUT VOLTAGE RANK LIST

The WHITE column shows applicable Voltage Rank(s)

Device Name	V <sub>out</sub>	Device Name	V <sub>out</sub>
NJM2888F15	1.5V	NJM2888F35	3.5V
NJM2888F16	1.6V	NJM2888F36	3.6V
NJM2888F17	1.7V	NJM2888F37	3.7V
NJM2888F18	1.8V	NJM2888F38	3.8V
NJM2888F19	1.9V	NJM2888F39	3.9V
NJM2888F02	2.0V	NJM2888F04	4.0V
NJM2888F21	2.1V	NJM2888F41	4.1V
NJM2888F22	2.2V	NJM2888F42	4.2V
NJM2888F23	2.3V	NJM2888F43	4.3V
NJM2888F24	2.4V	NJM2888F44	4.4V
NJM2888F25	2.5V	NJM2888F45	4.5V
NJM2888F26	2.6V	NJM2888F46	4.6V
NJM2888F27	2.7V	NJM2888F47	4.7V
NJM2888F28	2.8V	NJM2888F48	4.8V
NJM2888F29	2.9V	NJM2888F49	4.9V
NJM2888F03	3.0V	NJM2888F05	5.0V
NJM2888F31	3.1V		
NJM2888F32	3.2V		
NJM2888F33	3.3V		
NJM2888F34	3.4V		

The WHITE column shows applicable Voltage Rank(s)

Device Name	V <sub>out</sub>	Device Name	V <sub>out</sub>
NJM2888KF1-15	1.5V	NJM2888KF1-35	3.5V
NJM2888KF1-16	1.6V	NJM2888KF1-36	3.6V
NJM2888KF1-17	1.7V	NJM2888KF1-37	3.7V
NJM2888KF1-18	1.8V	NJM2888KF1-38	3.8V
NJM2888KF1-19	1.9V	NJM2888KF1-39	3.9V
NJM2888KF1-02	2.0V	NJM2888KF1-04	4.0V
NJM2888KF1-21	2.1V	NJM2888KF1-41	4.1V
NJM2888KF1-22	2.2V	NJM2888KF1-42	4.2V
NJM2888KF1-23	2.3V	NJM2888KF1-43	4.3V
NJM2888KF1-24	2.4V	NJM2888KF1-44	4.4V
NJM2888KF1-25	2.5V	NJM2888KF1-45	4.5V
NJM2888KF1-26	2.6V	NJM2888KF1-46	4.6V
NJM2888KF1-27	2.7V	NJM2888KF1-47	4.7V
NJM2888KF1-28	2.8V	NJM2888KF1-48	4.8V
NJM2888KF1-29	2.9V	NJM2888KF1-49	4.9V
NJM2888KF1-03	3.0V	NJM2888KF1-05	5.0V
NJM2888KF1-31	3.1V		
NJM2888KF1-32	3.2V		
NJM2888KF1-33	3.3V		
NJM2888KF1-34	3.4V		

**■ ABSOLUTE MAXIMUM RATINGS** (Ta=25°C)

PARAMETER	SYMBOL	RATINGS	UNIT	
Input Voltage	V <sub>IN</sub>	+10	V	
Control Voltage	V <sub>CONT</sub>	+10	V	
Power Dissipation	P <sub>D</sub>	SOT-23-5	350(*1)	mW
			200(*2)	
		ESON4	150(*3)	
			800(*4)	
Operating Temperature	Topr	-40 ~ +85	°C	
Storage Temperature	Tstg	-40 ~ +125	°C	

(\*1): Mounted on glass epoxy board based on EIA/JEDEC. (114.3×76.2×1.6mm: 2Layers FR-4)

(\*2): Device itself.

(\*2): Mounted on glass epoxy board based on EIA/JEDEC STANDARD. (101.5×114.5×1.6mm: 2Layers FR-4)

(\*3): Mounted on glass epoxy board based on EIA/JEDEC STANDARD. (101.5 × 114.5 × 1.6mm: 4Layers FR-4, Internal foil area size: 99.5 × 99.5mm, Applying a thermal via hole to a board based on JEDEC standard JESD51-5)

**■ Operating voltage**

V<sub>IN</sub>=+2.3 ~ +9V (In case of Vo<2.1V version)

**■ ELECTRICAL CHARACTERISTICS**

(V<sub>IN</sub>=Vo+1V, C<sub>IN</sub>=0.1μF, Co=1.0μF: Vo≥2.7V (Co=2.2μF : 1.8V<Vo≤2.6V, Co=4.7μF : Vo≤1.8V), Ta=25°C)

PARAMETER	SYMBOL	TEST CONDITION	MIN.	TYP.	MAX.	UNIT
Output Voltage	Vo	Io=30mA	-1.0%	-	+1.0%	V
Quiescent Current	I <sub>Q</sub>	Io=0mA, Except I <sub>CONT</sub>	-	130	195	μA
Quiescent Current at Control OFF	I <sub>Q(OFF)</sub>	V <sub>CONT</sub> =0V	-	-	100	nA
Output Current	Io	Vo - 0.3V	300	400	-	mA
Line Regulation	ΔVo/ΔV <sub>IN</sub>	V <sub>IN</sub> =Vo+1V ~ Vo+6V (Vo≤3V Version), V <sub>IN</sub> =Vo+1V ~ 9V (Vo>3V Version), Io=30mA	-	-	0.10	%/V
Load Regulation	ΔVo/ΔIo	Io=0 ~ 300mA	-	-	0.009	%/mA
Dropout Voltage (*5)	ΔV <sub>I-O</sub>	Io=100mA	-	0.10	0.18	V
Ripple Rejection	RR	ein=200mVrms, f=1kHz, Io=10mA, Vo=3V Version	-	75	-	dB
Average Temperature Coefficient of Output Voltage	ΔVo/ΔTa	Ta=0 ~ 85°C, Io=10mA	-	± 50	-	ppm/°C
Output Noise Voltage	V <sub>NO</sub>	f=10Hz ~ 80kHz, Io=10mA, Vo=3V Version	-	45	-	μVrms
Control Current	I <sub>CONT</sub>	V <sub>CONT</sub> =1.6V	-	3	12	μA
Control Voltage for ON-state	V <sub>CONT(ON)</sub>		1.6	-	-	V
Control Voltage for OFF-state	V <sub>CONT(OFF)</sub>		-	-	0.6	V
Input Voltage	V <sub>IN</sub>		-	-	9	V

(\*5): The output voltage excludes under 2.1V.

The above specification is a common specification for all output voltages.

Therefore, it may be different from the individual specification for a specific output voltage.

# NJM2888

## ■ TEST CIRCUIT

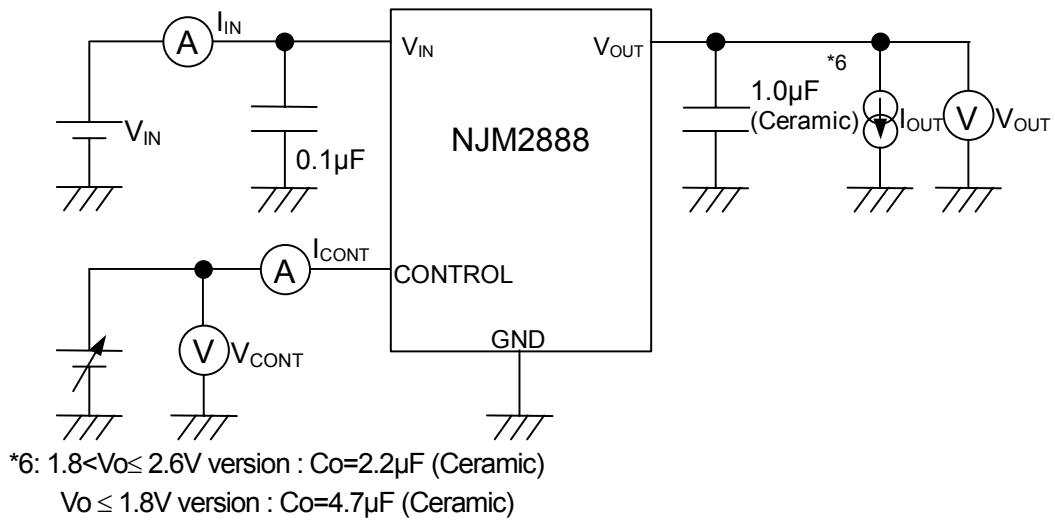

## ■ TYPICAL APPLICATION

① In the case where ON/OFF Control is not required:

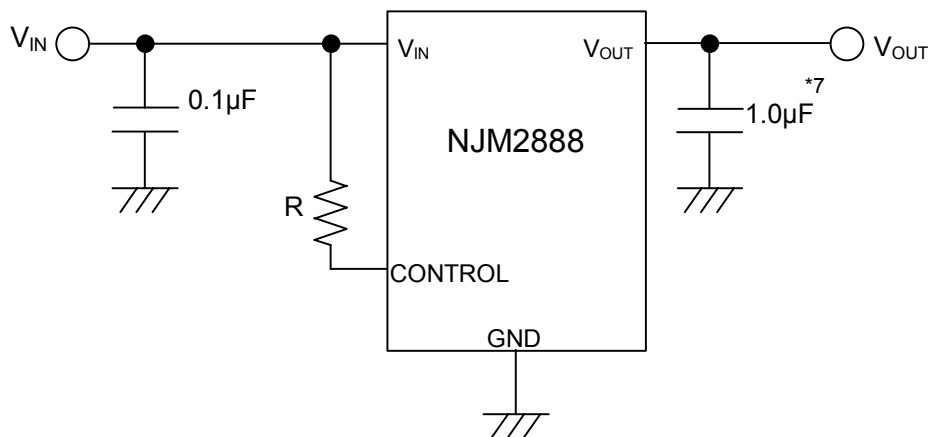

Connect control terminal to  $V_{IN}$  terminal

② In use of ON/OFF CONTROL:

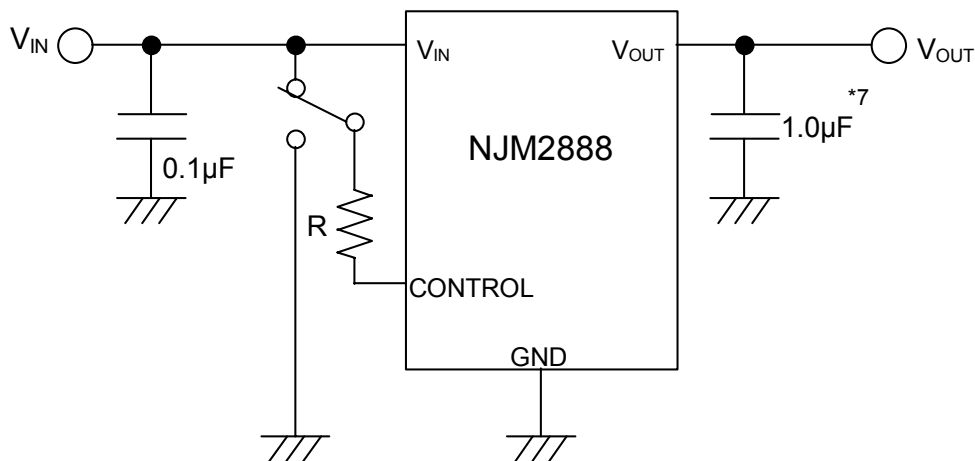

\*7: 1.8<V<sub>o</sub>≤ 2.6V version : C<sub>o</sub>=2.2µF  
 V<sub>o</sub> ≤ 1.8V version : C<sub>o</sub>=4.7µF

State of control terminal:

- “H” → output is enabled.
- “L” or “open” → output is disabled.

**\*Input Capacitance C<sub>IN</sub>**

Input Capacitance C<sub>IN</sub> is required to prevent oscillation and reduce power supply ripple for applications with high power supply impedance or a long power supply line.  
 Use the C<sub>IN</sub> value of 0.1µF greater to avoid the problem.  
 C<sub>IN</sub> should connect between GND and V<sub>IN</sub> as short as possible.

**\*In the case of using a resistance "R" between V<sub>IN</sub> and control.**

The current flow into the control terminal while the IC is ON state (I<sub>CONT</sub>) can be reduced when a pull up resistance "R" is inserted between V<sub>IN</sub> and the control terminal.  
 The minimum control voltage for ON state (V<sub>CONT(ON)</sub>) is increased due to the voltage drop caused by I<sub>CONT</sub> and the resistance "R". The I<sub>CONT</sub> is temperature dependence as shown in the "Control Current vs. Temperature" characteristics. Therefore, the resistance "R" should be carefully selected to ensure the control voltage exceeds the V<sub>CONT(ON)</sub> over the required temperature range.

# NJM2888

## POWER DISSIPATION vs. AMBIENT TEMPERATURE

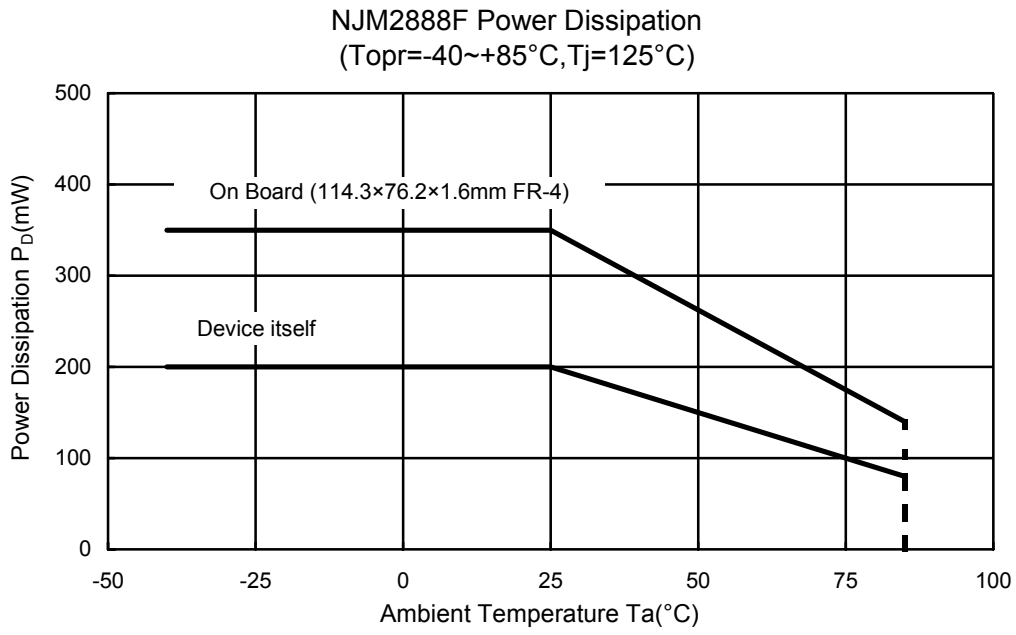

## ■ TYPICAL CHARACTERISTICS

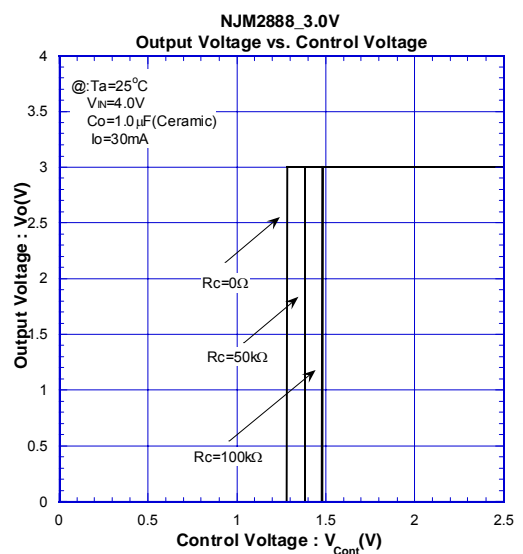
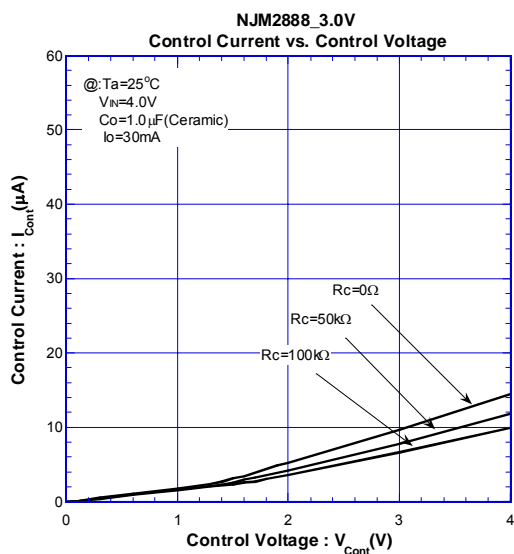
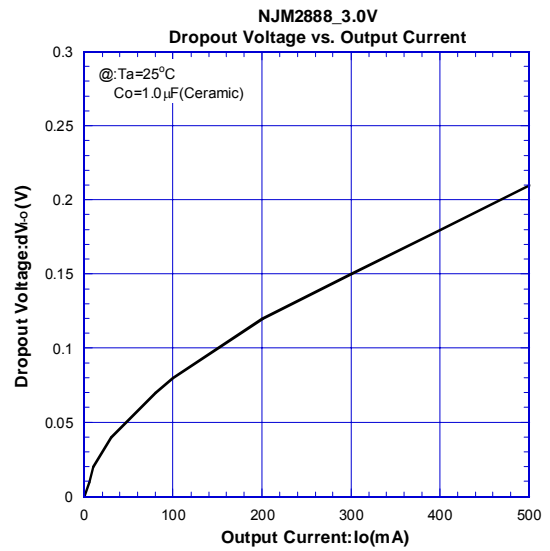
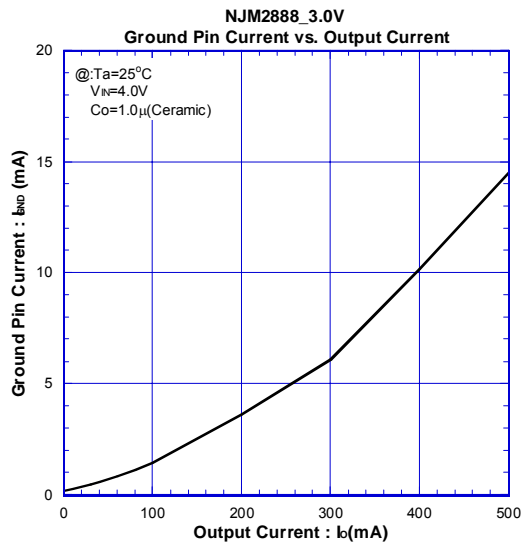
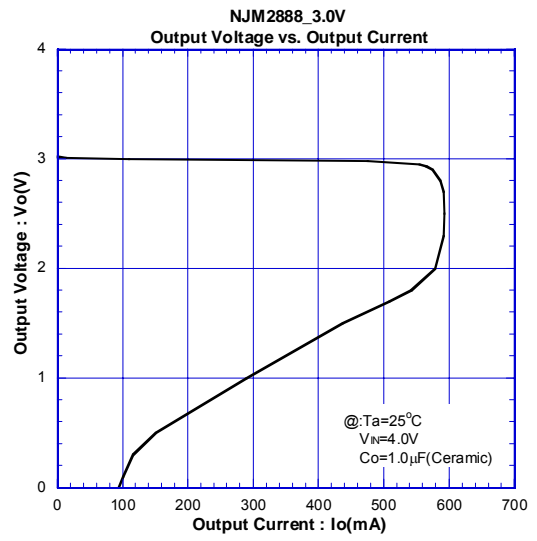
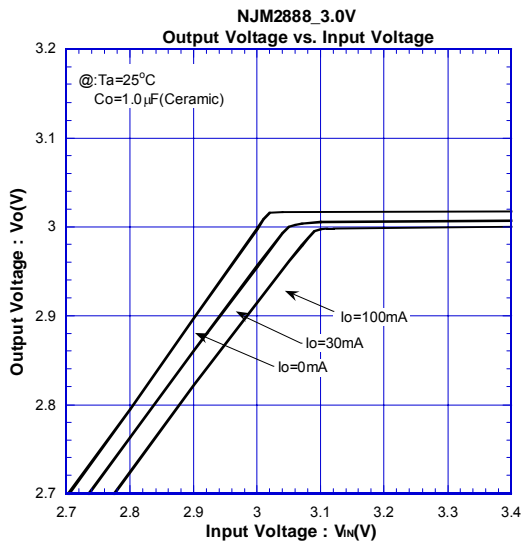

# NJM2888

## TYPICAL CHARACTERISTICS

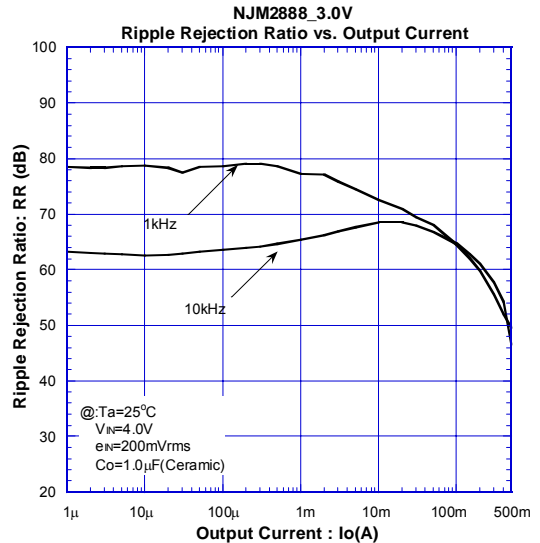
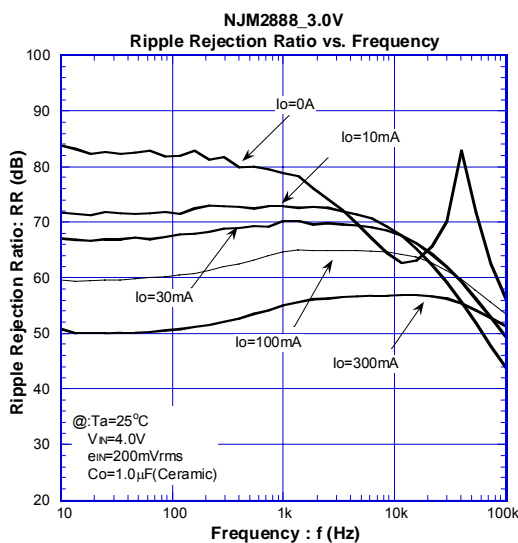
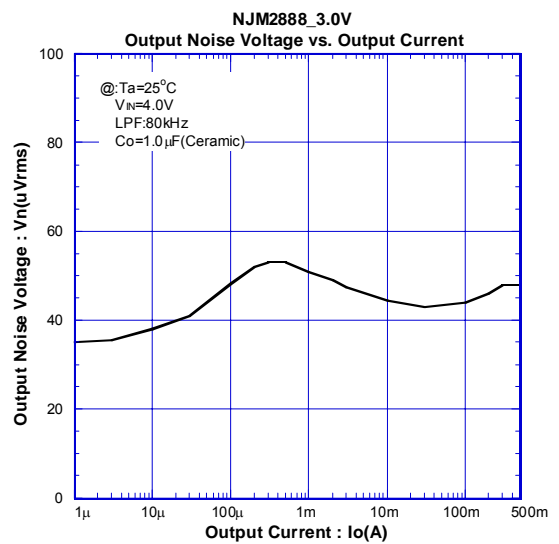
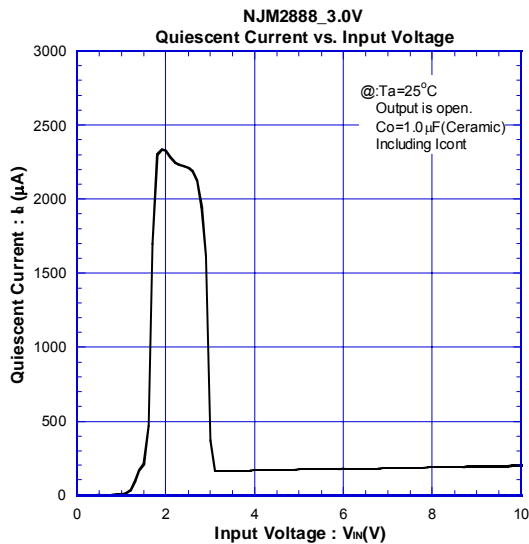
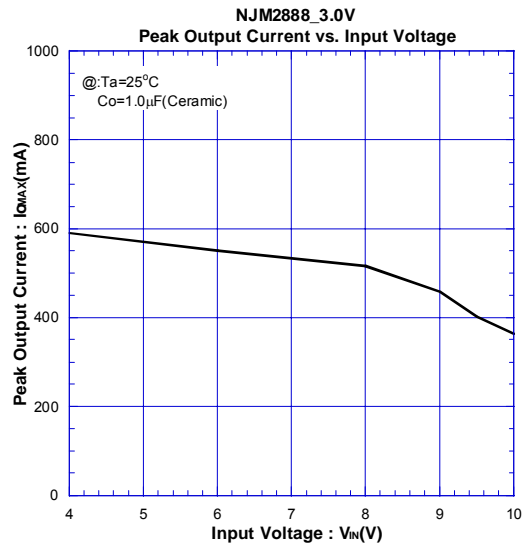
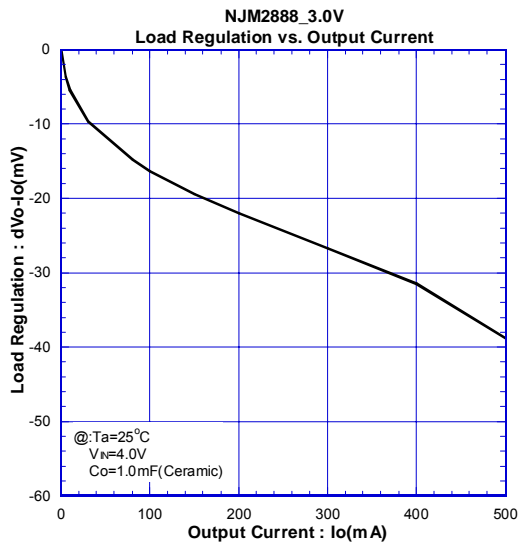



## ■ TYPICAL CHARACTERISTICS

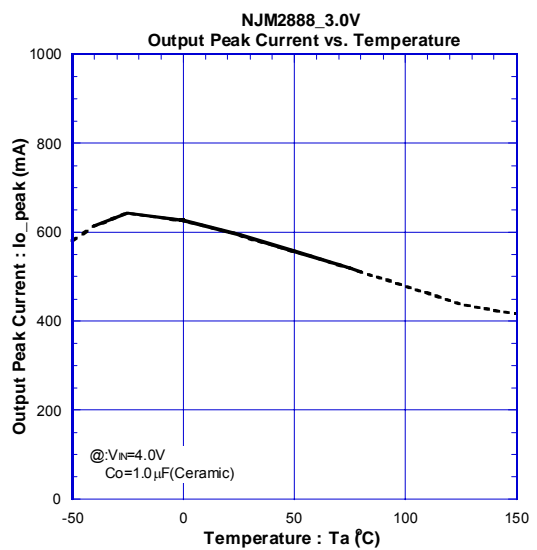
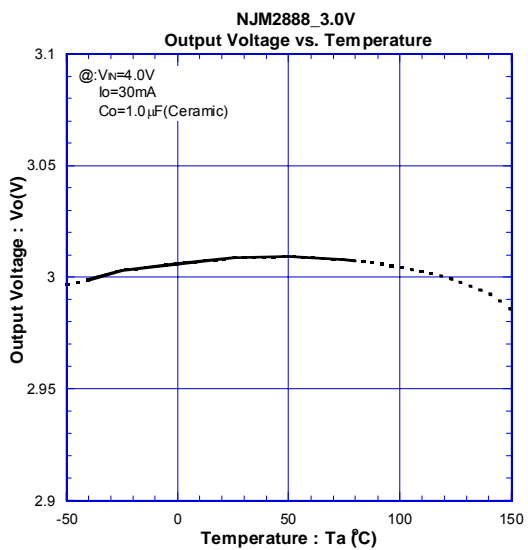
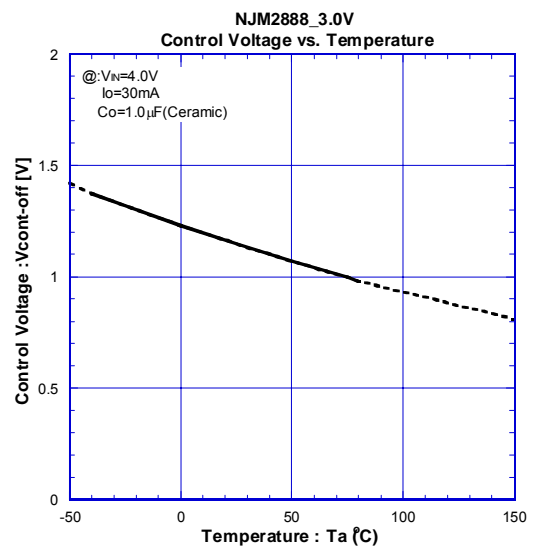
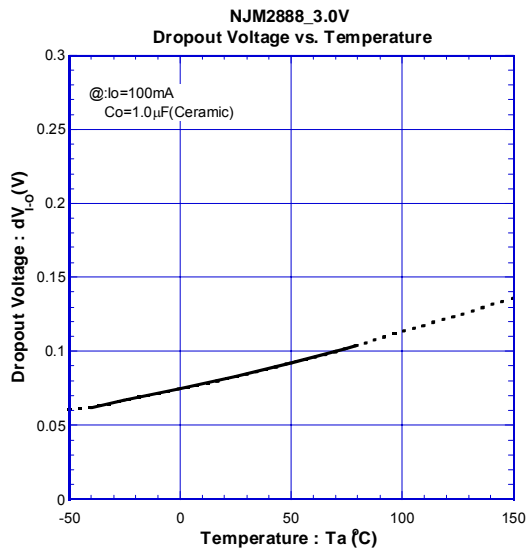
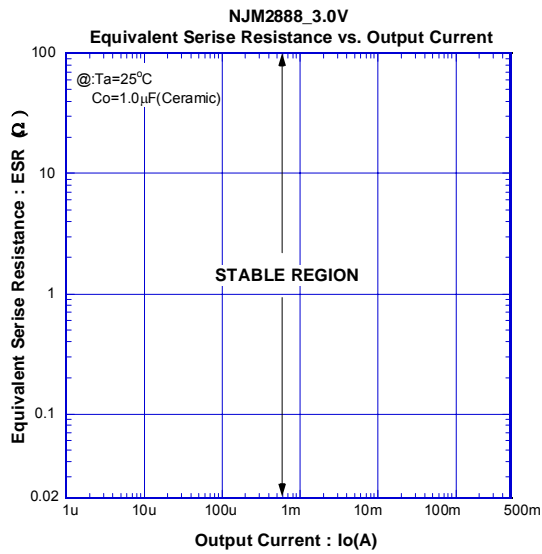

## TYPICAL CHARACTERISTICS

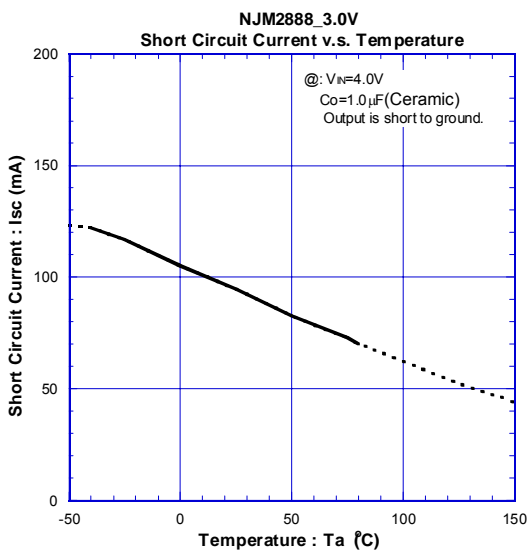
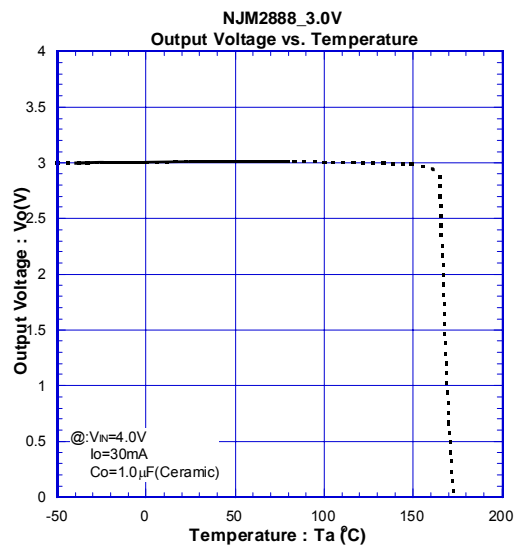
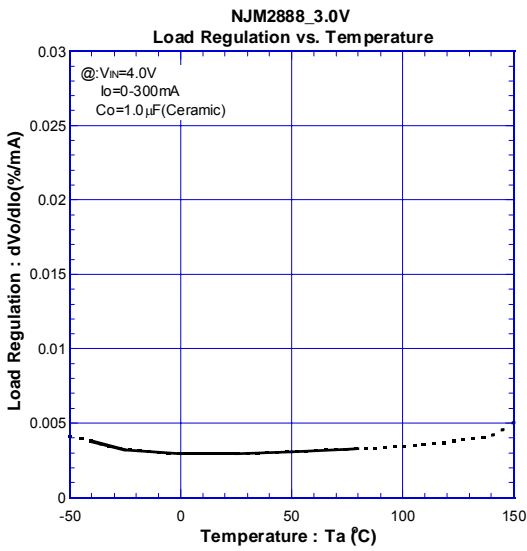
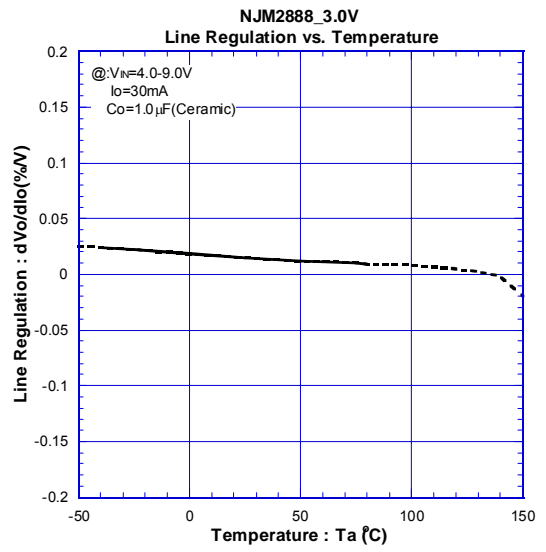
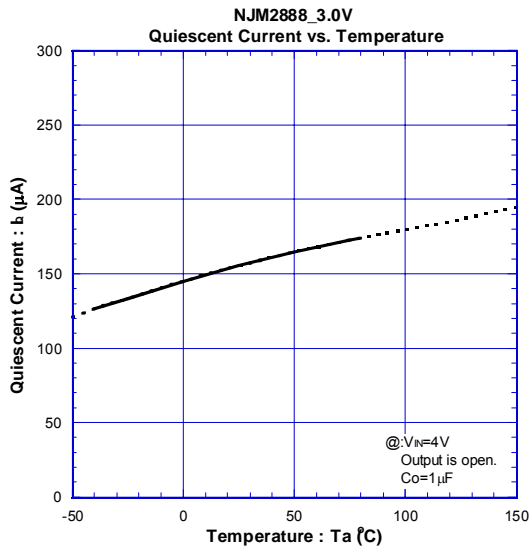

## TYPICAL CHARACTERISTICS

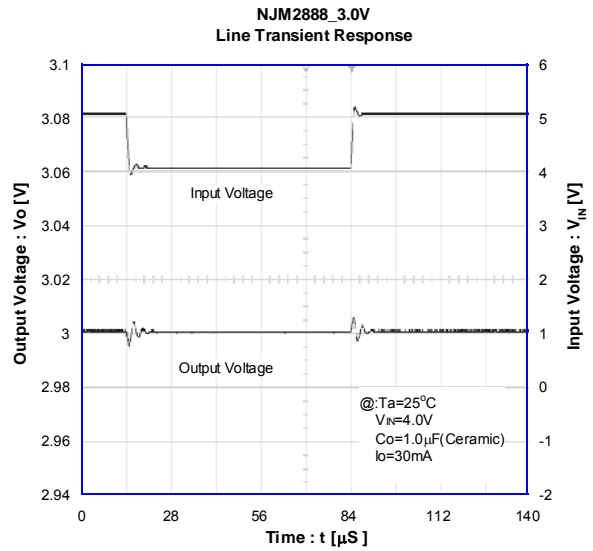
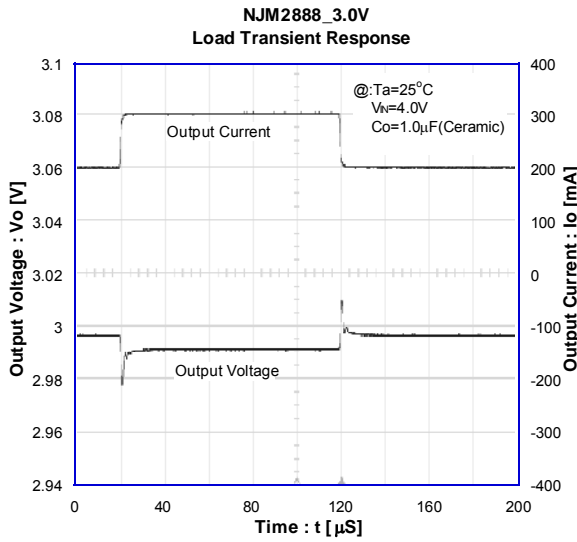
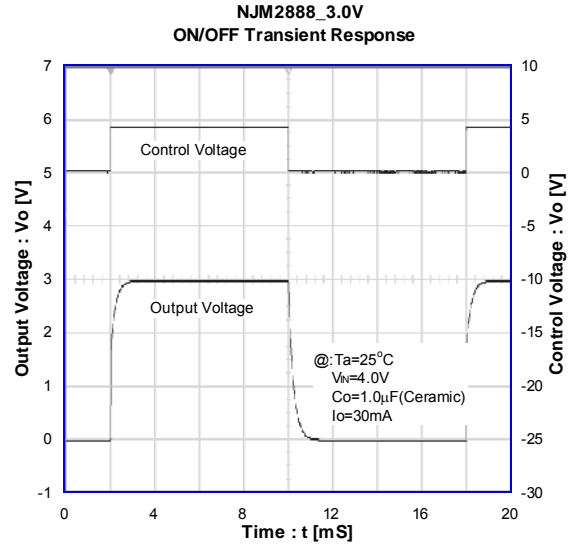
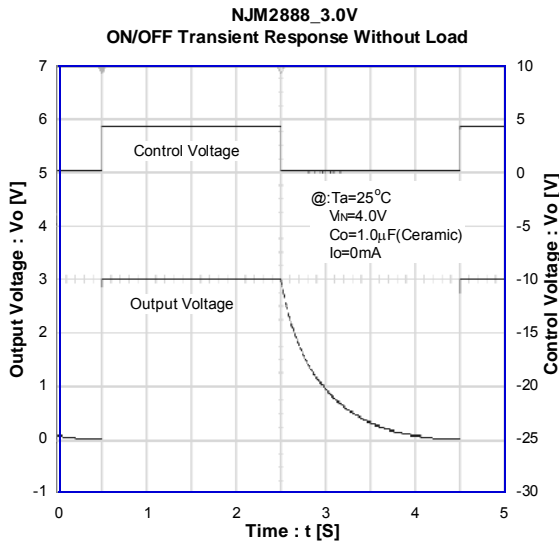

[CAUTION]  
The specifications on this databook are only given for information, without any guarantee as regards either mistakes or omissions. The application circuits in this databook are described only to show representative usages of the product and not intended for the guarantee or permission of any right including the industrial rights.