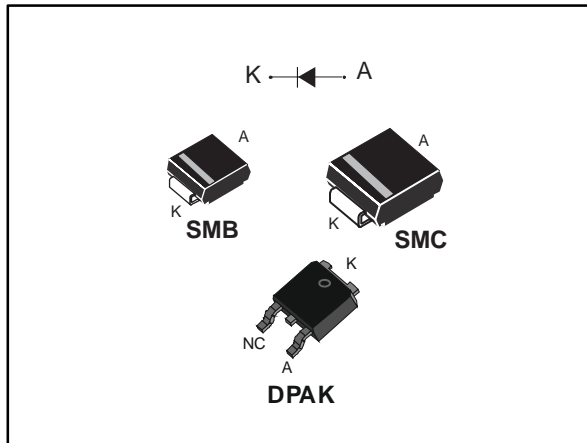


## Automotive ultrafast recovery diode

Datasheet - production data



### Features

- Very low conduction losses
- Negligible switching losses
- Low forward and reverse recovery times
- High junction temperature
- PPAP capable
- AEC-Q101 qualified

### Description

This device uses ST's new 200 V planar Pt doping technology, and it is especially suited for switching mode base drive and transistor circuits.

Packaged in SMB, SMC and DPAK, it is intended for use in low voltage, high frequency inverters, freewheeling and polarity protection in automotive applications.

**Table 1: Device summary**

Symbol	Value
$I_{F(AV)}$	4 A
$V_{RRM}$	200 V
$T_j$ (max.)	175 °C
$V_F$ (typ.)	0.76 V
$t_{rr}$ (typ.)	16 ns

# 1 Characteristics

**Table 2: Absolute ratings (limiting values at 25 °C, unless otherwise specified)**

Symbol	Parameter		Value	Unit
V <sub>R</sub> RM	Repetitive peak reverse voltage	T <sub>j</sub> = -40 °C to + 175 °C	200	V
I <sub>F</sub> (RMS)	Forward rms current		10	A
I <sub>F</sub> (AV)	Average forward current δ = 0.5, square wave	DPAK	4	A
		SMB, SMC		
I <sub>F</sub> SM	Surge non repetitive forward current	t <sub>p</sub> = 10 ms sinusoidal	70	A
T <sub>stg</sub>	Storage temperature range		-65 to +175	°C
T <sub>j</sub>	Maximum operating junction temperature <sup>(1)</sup>		-40 to +175	°C

**Notes:**

<sup>(1)</sup>(dP<sub>tot</sub>/dT<sub>j</sub>) < (1/R<sub>th(j-a)</sub>) condition to avoid thermal runaway for a diode on its own heatsink.

**Table 3: Thermal parameters**

Symbol	Parameter		Maximum	Unit
R <sub>th(j-c)</sub>	Junction to case	DPAK	3.5	°C/W
R <sub>th(j-l)</sub>	Junction to lead	SMB, SMC	20	

**Table 4: Static electrical characteristics**

Symbol	Parameter	Test conditions		Min.	Typ.	Max.	Unit
I <sub>R</sub> <sup>(1)</sup>	Reverse leakage current	T <sub>j</sub> = 25 °C	V <sub>R</sub> = V <sub>R</sub> RM	-		3	μA
		T <sub>j</sub> = 125 °C		-	2	20	
V <sub>F</sub> <sup>(2)</sup>	Forward voltage drop	T <sub>j</sub> = 25 °C	I <sub>F</sub> = 4 A	-	0.95	1.05	V
		T <sub>j</sub> = 150 °C		-	0.76	0.83	

**Notes:**

<sup>(1)</sup>Pulse test: t<sub>p</sub> = 5 ms, δ < 2%

<sup>(2)</sup>Pulse test: t<sub>p</sub> = 380 μs, δ < 2%

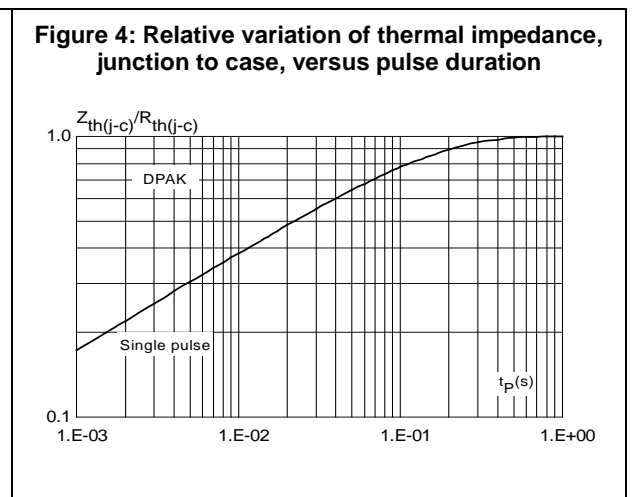
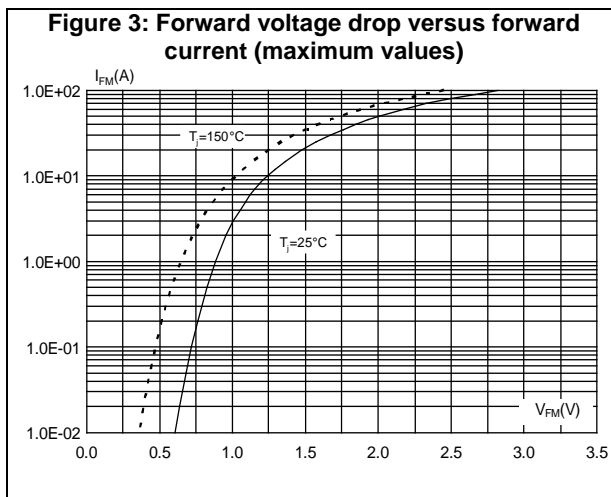
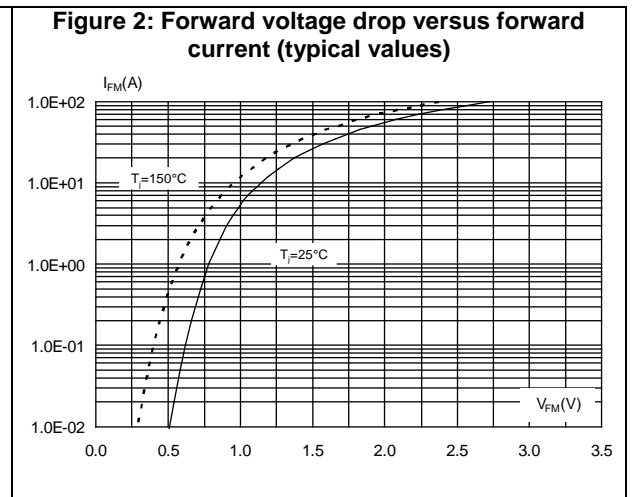
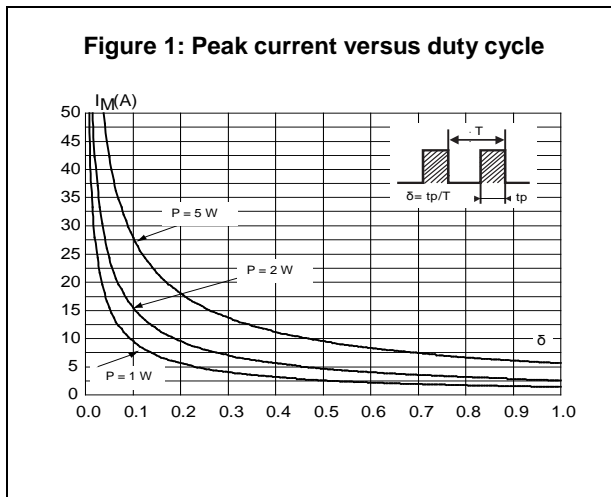
To evaluate the conduction losses use the following equation:

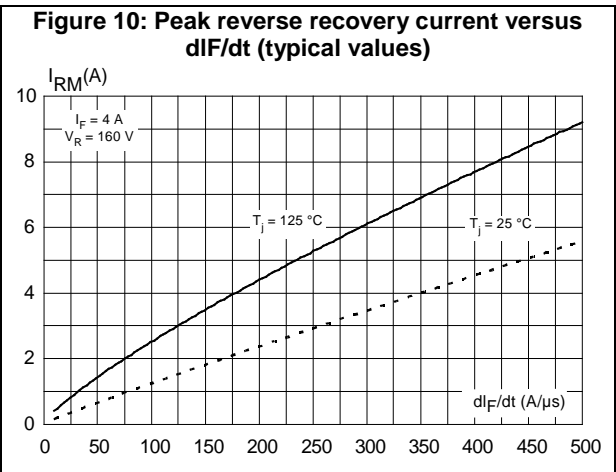
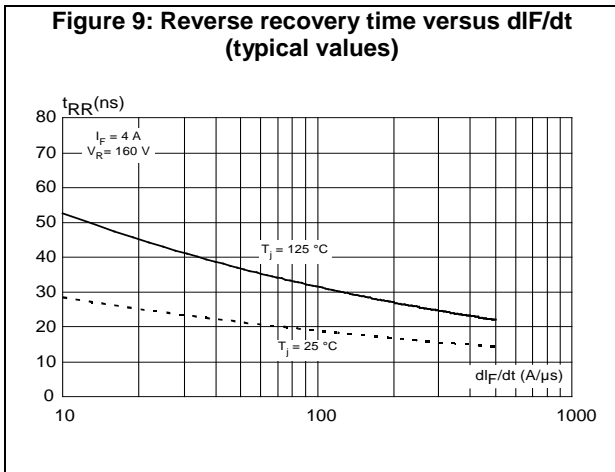
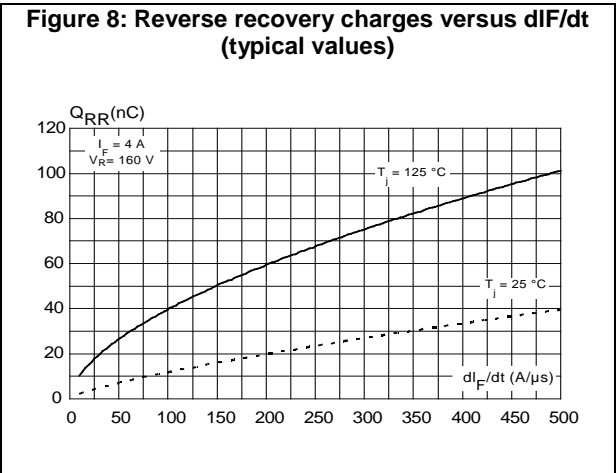
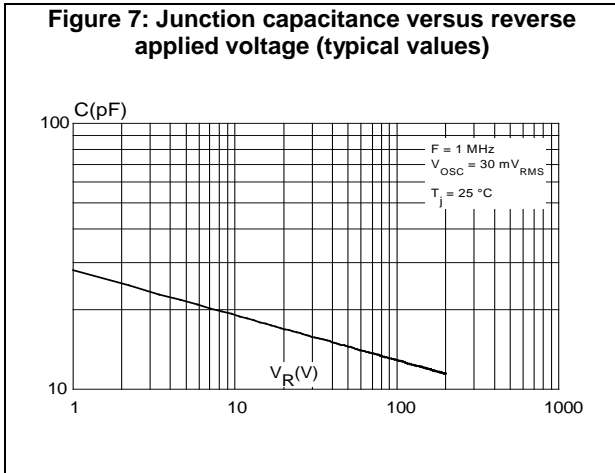
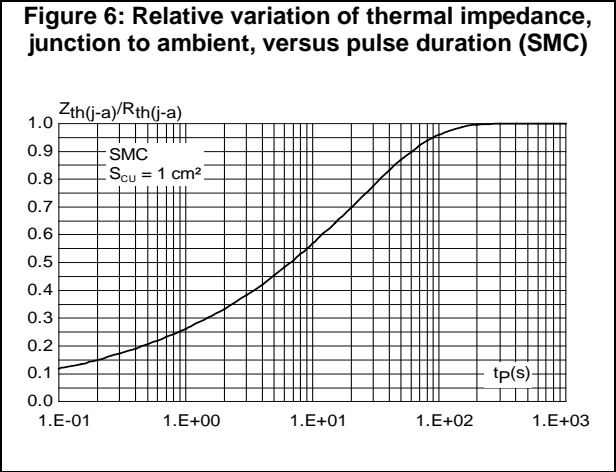
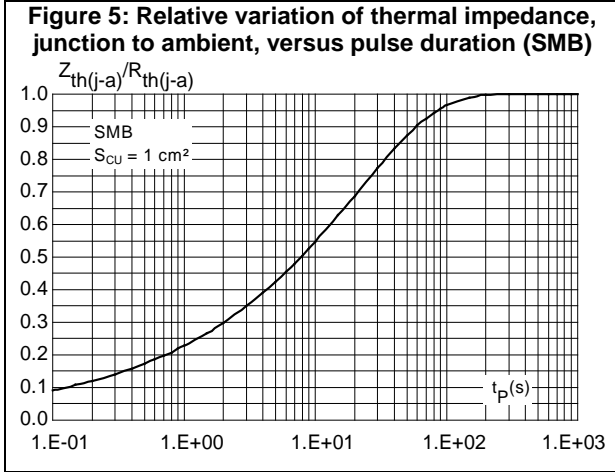
$$P = 0.67 \times I_{F(AV)} + 0.04 I_{F(RMS)}^2$$

Table 5: Dynamic characteristics

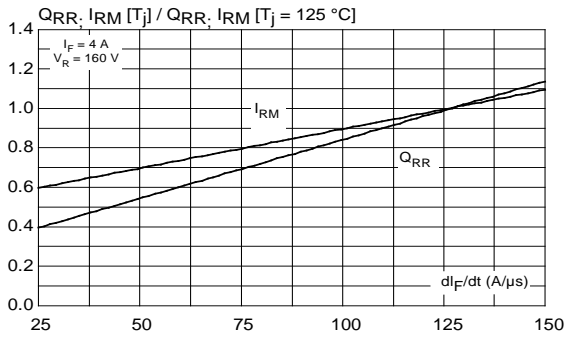
Symbol	Parameters	Test conditions		Min.	Typ.	Max.	Unit
$t_{rr}$	Reverse recovery time	$T_j = 25\text{ }^\circ\text{C}$	$I_F = 1\text{ A}; dI_F/dt = -50\text{ A}/\mu\text{s}; V_R = 30\text{ V}$	-	24	30	ns
			$I_F = 1\text{ A}; dI_F/dt = -100\text{ A}/\mu\text{s}; V_R = 30\text{ V}$	-	16	20	
$I_{RM}$	Reverse recovery current	$T_j = 125\text{ }^\circ\text{C}$	$I_F = 4\text{ A}; dI_F/dt = -200\text{ A}/\mu\text{s}; V_R = 160\text{ V}$	-	4.4	5.5	A
$t_{rr}$	Reverse recovery time			-	27		ns
$Q_{rr}$	Reverse recovery charges			-	60		nC

### 1.1 Characteristics (curves)

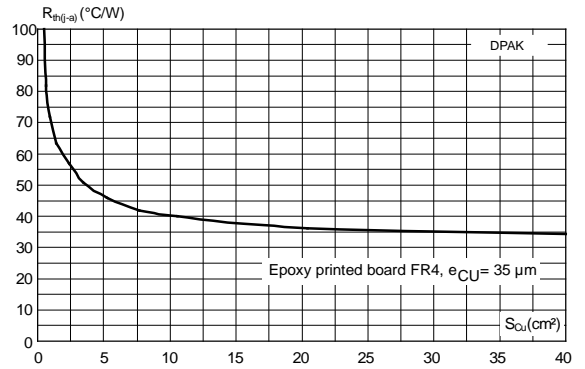




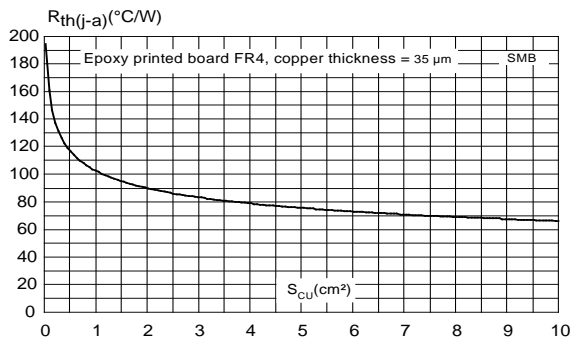
**Figure 11: Dynamic parameters versus junction temperature**



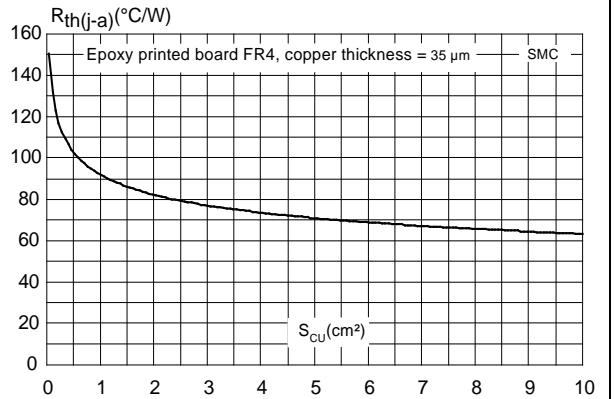
**Figure 12: Thermal resistance, junction to ambient, versus copper surface under tab**



**Figure 13: Thermal resistance, junction to ambient, versus copper surface under each lead**



**Figure 14: Thermal resistance, junction to ambient, versus copper surface under each lead**



## 2 Package information

In order to meet environmental requirements, ST offers these devices in different grades of ECOPACK® packages, depending on their level of environmental compliance. ECOPACK® specifications, grade definitions and product status are available at: [www.st.com](http://www.st.com). ECOPACK® is an ST trademark.

### 2.1 DPAK package information

Figure 15: DPAK package outline

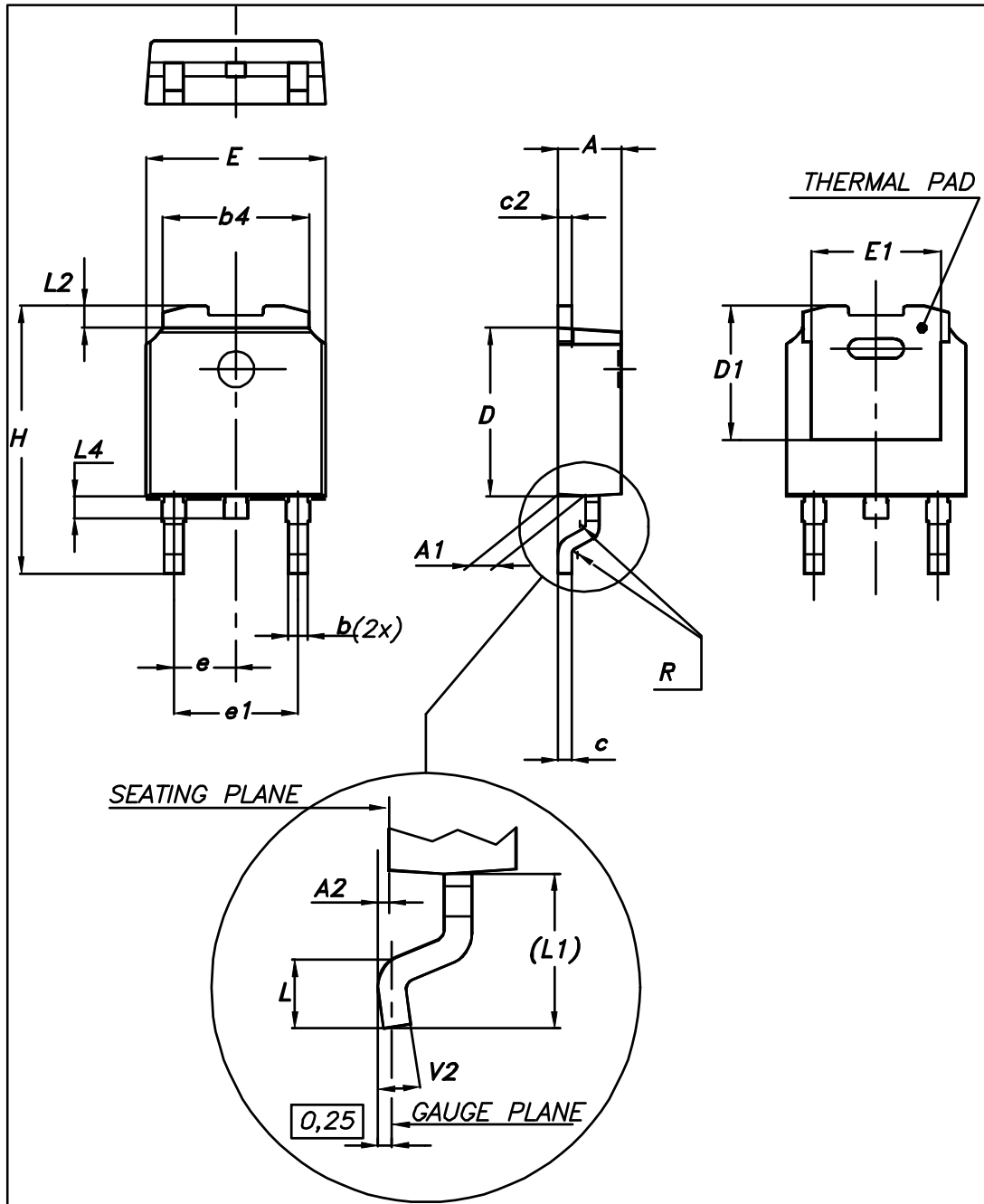
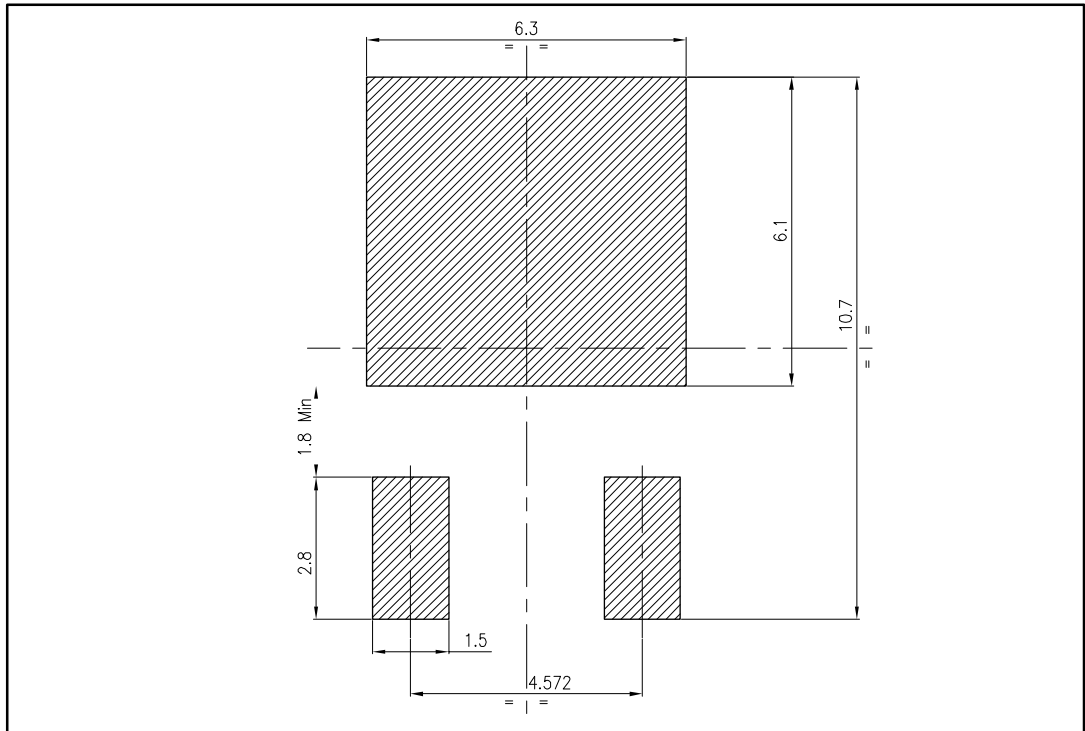


Table 6: DPAK mechanical data

Dim.	Dimensions					
	Millimeters			Inches		
	Min.	Typ.	Max.	Min.	Typ.	Max.
A	2.20		2.40	0.087		0.094
A1	0.90		1.10	0.035		0.043
A2	0.03		0.23	0.001		0.009
b	0.64		0.90	0.025		0.035
b4	5.20		5.40	0.205		0.213
c	0.45		0.60	0.018		0.024
c2	0.48		0.60	0.019		0.024
D	6.00		6.20	0.236		0.244
D1	4.95	5.10	5.25	0.201	0.195	0.207
E	6.40		6.60	0.252		0.260
E1	4.60	4.70	4.80	0.181	0.185	0.189
e	2.16	2.28	2.40	0.085	0.090	0.094
e1	4.40		4.60	0.173		0.181
H	9.35		10.10	0.368		0.398
L	1.00		1.50	0.039		0.059
(L1)	2.60	2.80	3.00	0.102	0.110	0.118
L2	0.65	0.80	0.95	0.026	0.031	0.037
L4	0.60		1.00	0.024		0.039
R		0.20			0.008	
V2	0°		8°	0°		8°

Figure 16: DPAK recommended footprint (dimensions are in mm)





## 2.2 SMC package information

Figure 17: SMC package outline

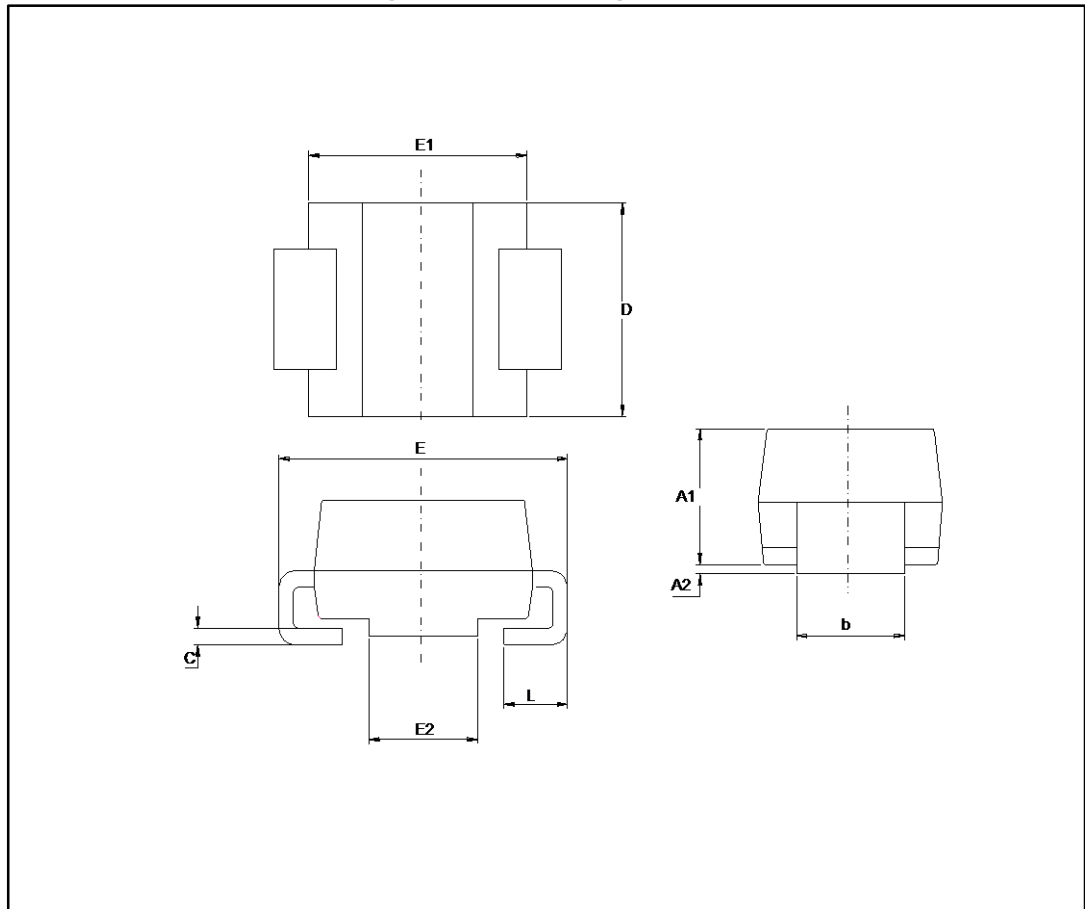
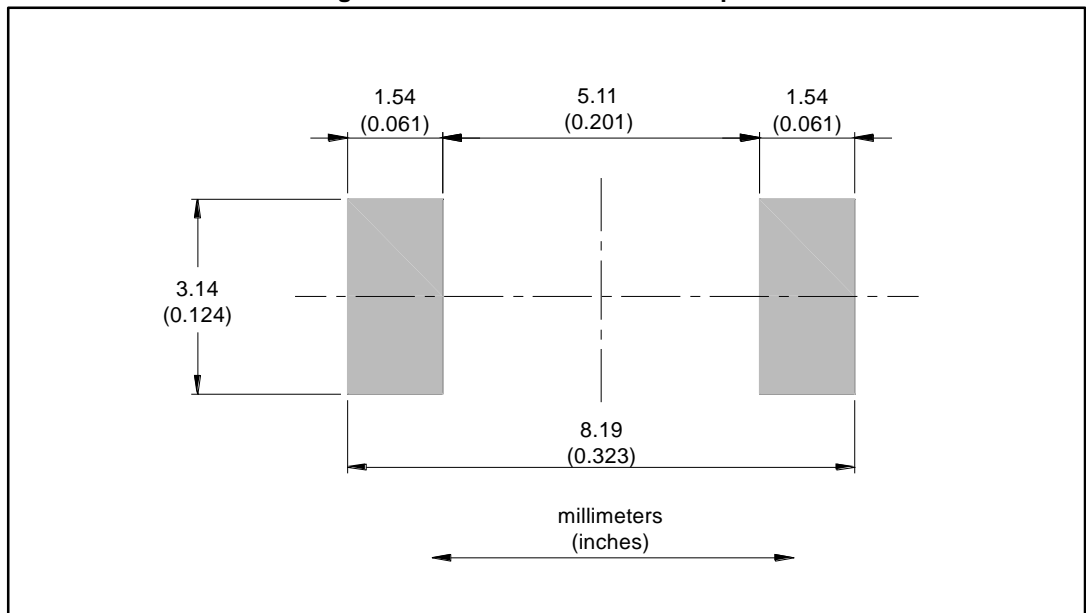


Table 7: SMC package mechanical data

Ref.	Dimensions			
	Millimeters		Inches	
	Min.	Max.	Min.	Max.
A1	1.90	2.45	0.0748	0.0965
A2	0.05	0.20	0.0020	0.0079
b	2.90	3.20	0.1142	0.1260
c	0.15	0.40	0.0059	0.0157
D	5.55	6.25	0.2185	0.2461
E	7.75	8.15	0.3051	0.3209
E1	6.60	7.15	0.2598	0.2815
E2	4.40	4.70	0.1732	0.1850
L	0.75	1.50	0.0295	0.0591

Figure 18: SMC recommended Footprint



### 2.3 SMB package information

Figure 19: SMB package outline

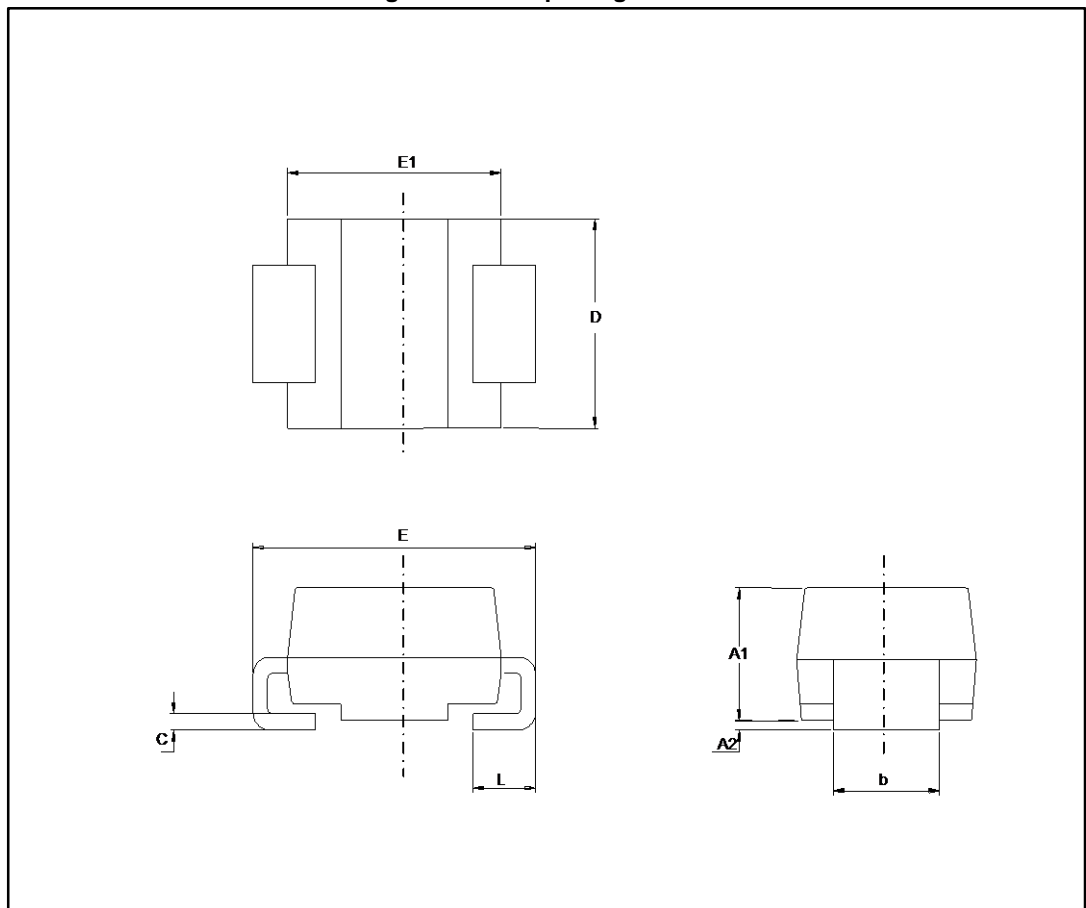
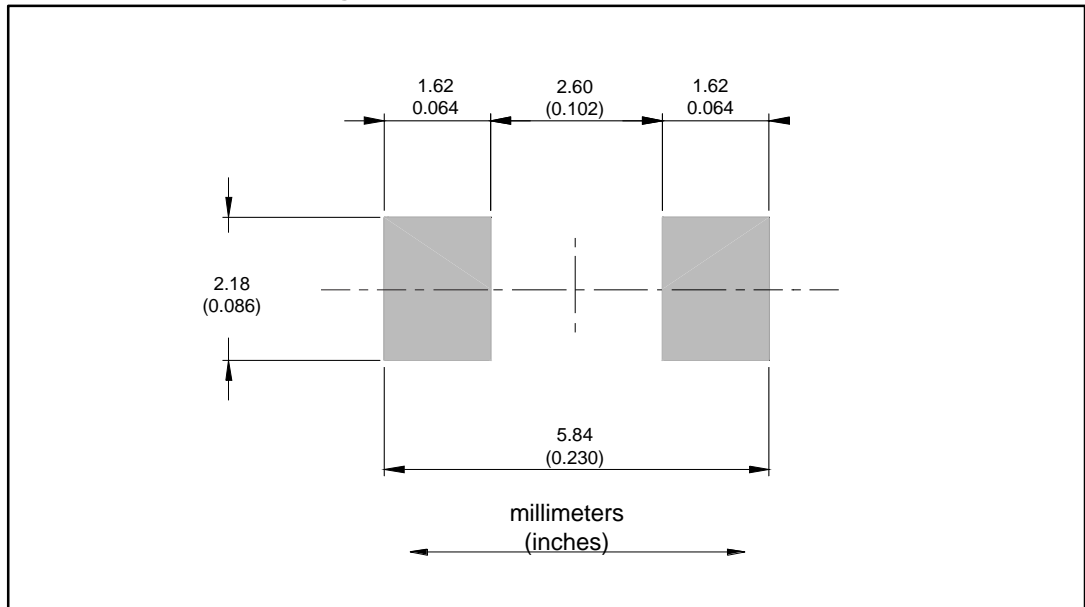


Table 8: SMB package mechanical data

Ref.	Dimensions			
	Millimeters		Inches	
	Min.	Max.	Min.	Max.
A1	1.90	2.45	0.0748	0.0965
A2	0.05	0.20	0.0020	0.0079
b	1.95	2.20	0.0768	0.0867
c	0.15	0.40	0.0059	0.0157
D	3.30	3.95	0.1299	0.1556
E	5.10	5.60	0.2008	0.2205
E1	4.05	4.60	0.1594	0.1811
L	0.75	1.50	0.0295	0.0591

Figure 20: SMB recommended Footprint



### 3 Ordering information

Figure 21: Ordering information scheme

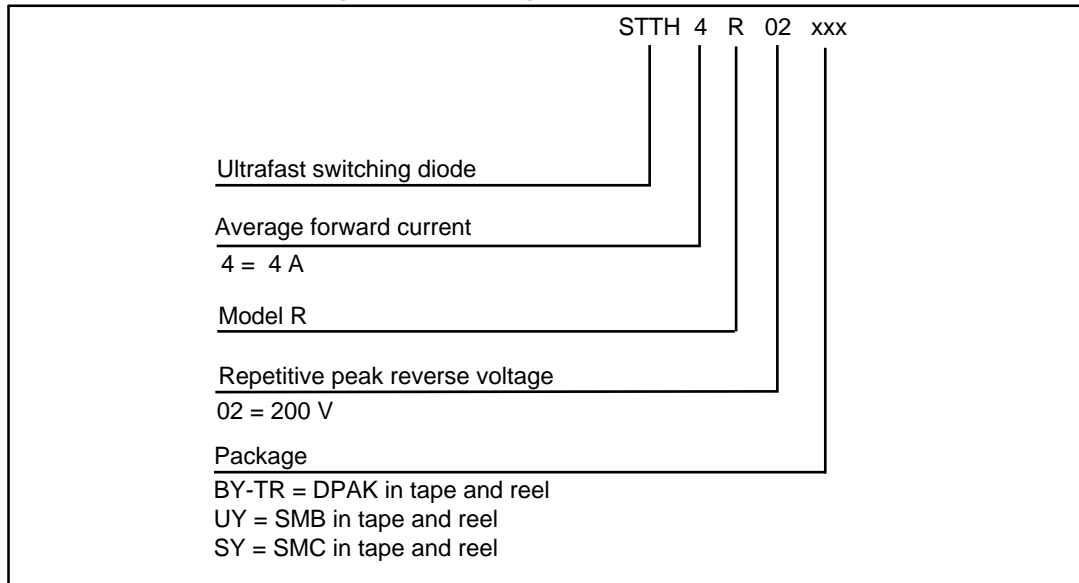


Table 9: Ordering information

Order code	Marking	Package	Weight	Base qty.	Delivery mode
STTH4R02BY-TR	STTH4 R02BY	DPAK	0.320 g	2500	Tape and reel
STTH4R02UY	4R2UY	SMB	0.110 g	2500	Tape and reel
STTH4R02SY	4R2SY	SMC	0.243 g	2500	Tape and reel

## 4 Revision history

**Table 10: Document revision history**

Date	Revision	Changes
03-Dec-2010	1	First issue
14-Apr-2016	2	Added device in DPAK. Updated features and description in cover page. Updated <i>Table 2: "Absolute ratings (limiting values at 25 °C, unless otherwise specified)"</i> , <i>Table 3: "Thermal parameters"</i> and <i>Table 5: "Dynamic characteristics"</i> . Updated <i>Figure 2: "Forward voltage drop versus forward current (typical values)"</i> and <i>Figure 3: "Forward voltage drop versus forward current (maximum values)"</i> . Updated <i>Section 4: "Ordering information"</i> .

**IMPORTANT NOTICE – PLEASE READ CAREFULLY**

STMicroelectronics NV and its subsidiaries ("ST") reserve the right to make changes, corrections, enhancements, modifications, and improvements to ST products and/or to this document at any time without notice. Purchasers should obtain the latest relevant information on ST products before placing orders. ST products are sold pursuant to ST's terms and conditions of sale in place at the time of order acknowledgement.

Purchasers are solely responsible for the choice, selection, and use of ST products and ST assumes no liability for application assistance or the design of Purchasers' products.

No license, express or implied, to any intellectual property right is granted by ST herein.

Resale of ST products with provisions different from the information set forth herein shall void any warranty granted by ST for such product.

ST and the ST logo are trademarks of ST. All other product or service names are the property of their respective owners.

Information in this document supersedes and replaces information previously supplied in any prior versions of this document.

© 2016 STMicroelectronics – All rights reserved