

IC for Human Body Detector

# Amplifier for Pyroelectric Infrared Sensor



BD9251FV

No.11096EAT01

## ●Description

BD9251FV is used for the human body detection application.

Make to single-chip, easy to use then before. Power-saving in the best design.

Reduce the standby power requirement of the device used always. Don't choose the mounting place by a space-saving.

## ●Features

- 1) Amplifier for sensor output
- 2) Comparator for sensor output
- 3) Built-in voltage regulator
- 4) Built-in moving detector

## ●Applications

Lighting, Sensor Light, Security system, WEB camera, TV, PC display, Air Conditioner, Ventilation fan

## ●Absolute Maximum Ratings (Ta=25°C)

| Parameter             | Symbol           | Ratings           | Units |
|-----------------------|------------------|-------------------|-------|
| Supply Voltage        | V <sub>DD</sub>  | -0.3~7.0          | V     |
| Power Dissipation     | P <sub>d</sub>   | 440* <sup>1</sup> | mW    |
| Operating Temperature | T <sub>opr</sub> | -30~75            | °C    |
| Storage Temperature   | T <sub>stg</sub> | -55~125           | °C    |

\*1. It reduces 3.5mW/°C then Ta≥25°C. (On glass epoxy board of 70mm×70mm×1.6mm)

## ●Operating Conditions

| Parameter             | Symbol                     | Ratings |      |      | Units | Conditions               |
|-----------------------|----------------------------|---------|------|------|-------|--------------------------|
|                       |                            | Min.    | Typ. | Max. |       |                          |
| Supply Voltage        | V <sub>DD</sub>            | 2.97    | 5.0  | 6.0  | V     |                          |
| A1P_IN Offset Voltage | V <sub>A1P_IN_OFFSET</sub> | -       | 1.5  | -    | V     | V <sub>DRAIN</sub> =2.3V |

This product doesn't design for protection radioactive rays.

## ●Electric Characteristics (VDD=5.0V, Ta=25°C)

| Parameter                        | Symbol              | Limits               |      |                      | Units | Conditions   |
|----------------------------------|---------------------|----------------------|------|----------------------|-------|--|
|                                  |                     | Min.                 | Typ. | Max.                 |       |  |
| Supply Current                   | I <sub>DD</sub>     | -                    | 300  | 400                  | uA    | Output no load   |
| DRAIN Output Voltage             | V <sub>DRAIN</sub>  | 2.0                  | 2.3  | -                    | V     | V <sub>DD</sub> ≥ 2.97V,<br>I <sub>DRAIN</sub> ≤ 100μA |
| AMP1/AMP2 Input Voltage          | V <sub>IN</sub>     | 0.1                  | -    | V <sub>DD</sub> -0.8 | V     |  |
| AMP1/AMP2 Gain                   | A <sub>G</sub>      | -                    | -    | 46                   | dB    |  |
| AMP1/AMP2 Unity Gain             | A <sub>UG</sub>     | -                    | 1    | -                    | MHz   |  |
| AMP1 Input Offset Voltage        | V <sub>A1OFF</sub>  | -                    | -    | 10                   | mV    |  |
| AMP2 Output Offset Voltage       | V <sub>A2OUT</sub>  | -                    | 1.5  | -                    | V     |  |
| A2_OUT Output Current (source)   | I <sub>A2OUT1</sub> | 20                   | 30   | -                    | μA    |  |
| A2_OUT Output Current (sink)     | I <sub>A2OUT2</sub> | 20                   | 200  | -                    | μA    |  |
| D_OUT / T_OUT Output "H" Voltage | V <sub>OH</sub>     | V <sub>DD</sub> -0.6 | -    | V <sub>DD</sub>      | V     | I <sub>OH</sub> =-1mA                                  |
| D_OUT / T_OUT Output "L" Voltage | V <sub>OL</sub>     | 0                    | -    | 0.6                  | V     | I <sub>OL</sub> =+1mA                                  |

●Electrical characteristic curves (Reference data)

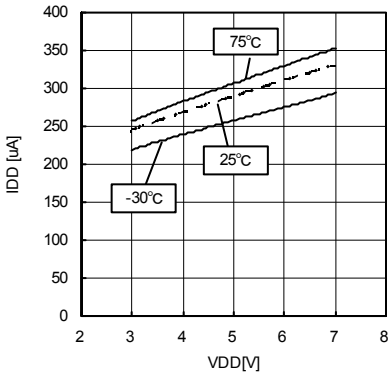

Fig.1 IDD

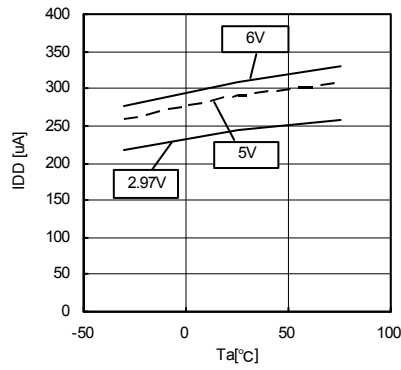

Fig.2 IDD

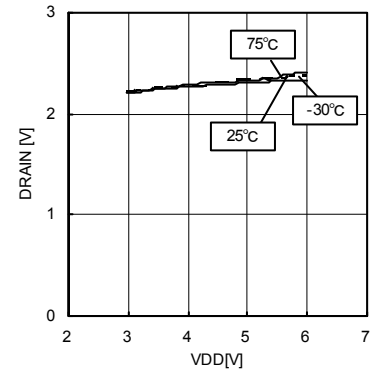

Fig.3 Drain Voltage (source 100μA)

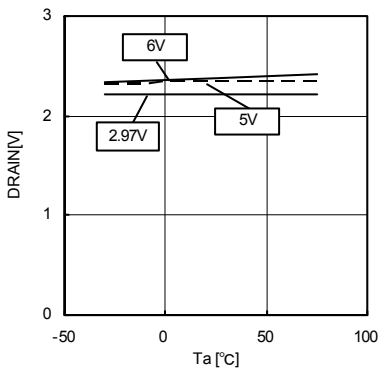

Fig.4 Drain Voltage (source 100μA)

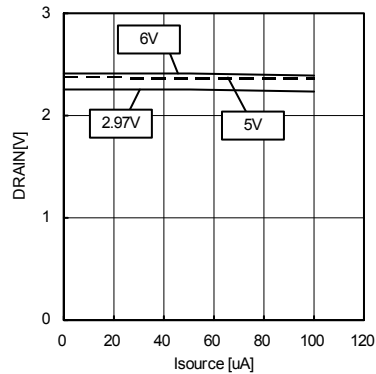

Fig.5 Drain Voltage (Ta=25°C)

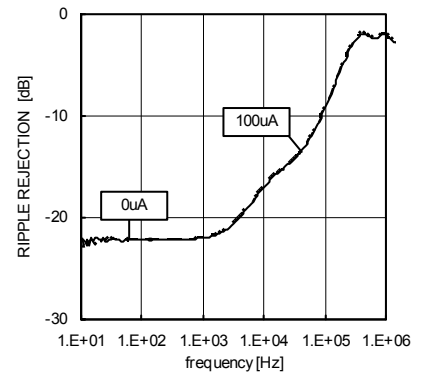

Fig.6 Drain Voltage PSRR (Ta=25°C) VDD=2.97V

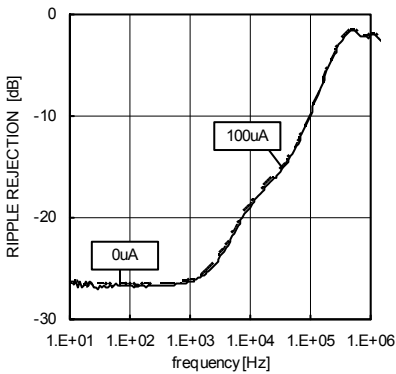

Fig.7 Drain Voltage PSRR (Ta=25°C) VDD=5.0V

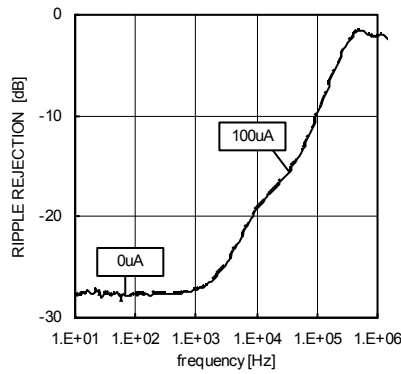

Fig.8 Drain Voltage PSRR (Ta=25°C) VDD=6.0V

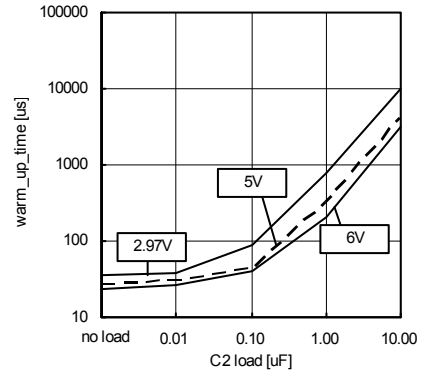

Fig.9 DRAIN VOLTAGE warm\_up\_time (Ta=25°C)

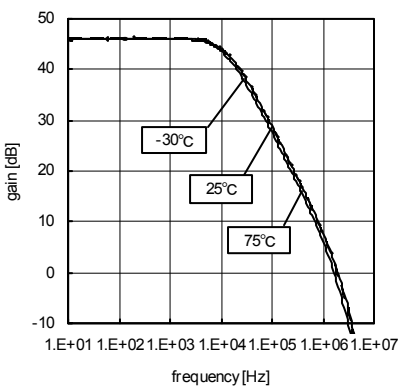

Fig.10 amp1/amp2 closed-loop-gain VDD=2.97V

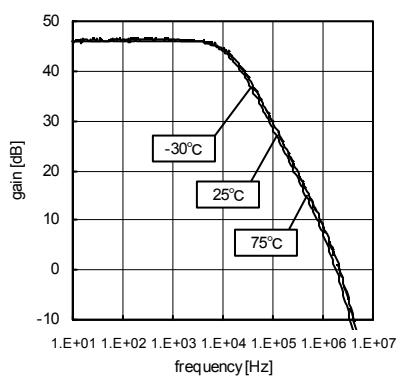

Fig.11 amp1/amp2 closed-loop-gain VDD=5V

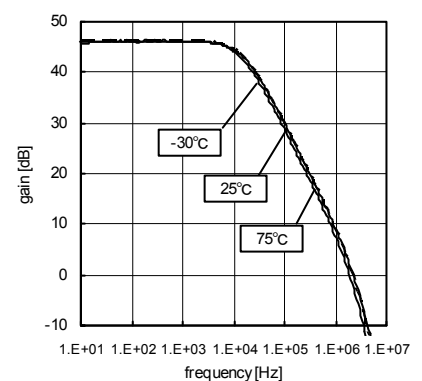

Fig.12 amp1/amp2 closed-loop-gain VDD=6V

●Electrical characteristic curves (Reference data) – Continued

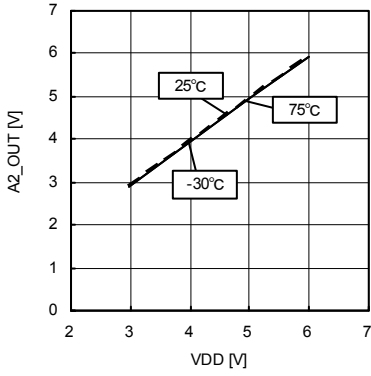

Fig.13 AMP2 Output High Voltage (source 20uA)

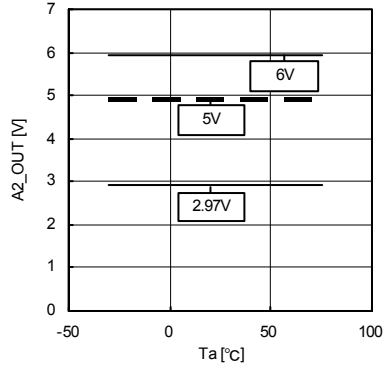

Fig.14 AMP2 Output High Voltage (source 20uA)

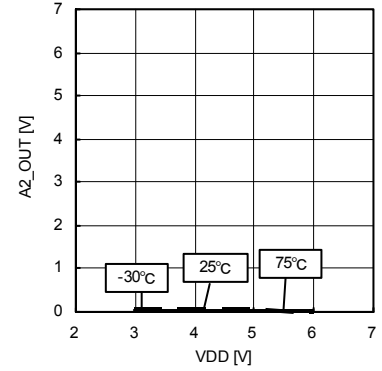

Fig.15 AMP2 Output Low Voltage (sink 20uA)

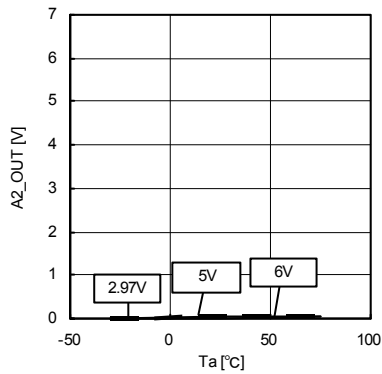

Fig.16 AMP2 Output Low Voltage (source 20uA)

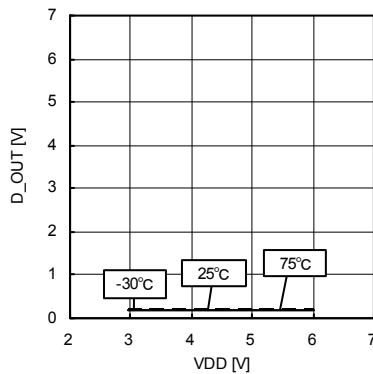

Fig.17 D\_OUT Output Low Voltage (sink 1mA)

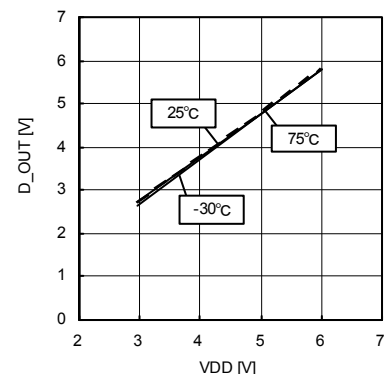

Fig.18 D\_OUT Output High Voltage (source 1mA)

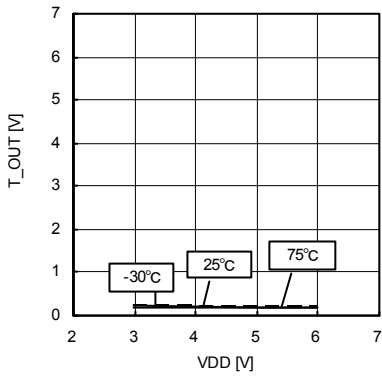

Fig.19 T\_OUT Output Low Voltage (sink 1mA)

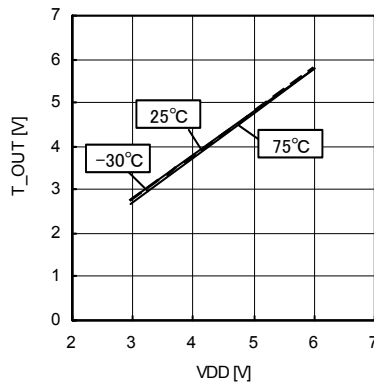
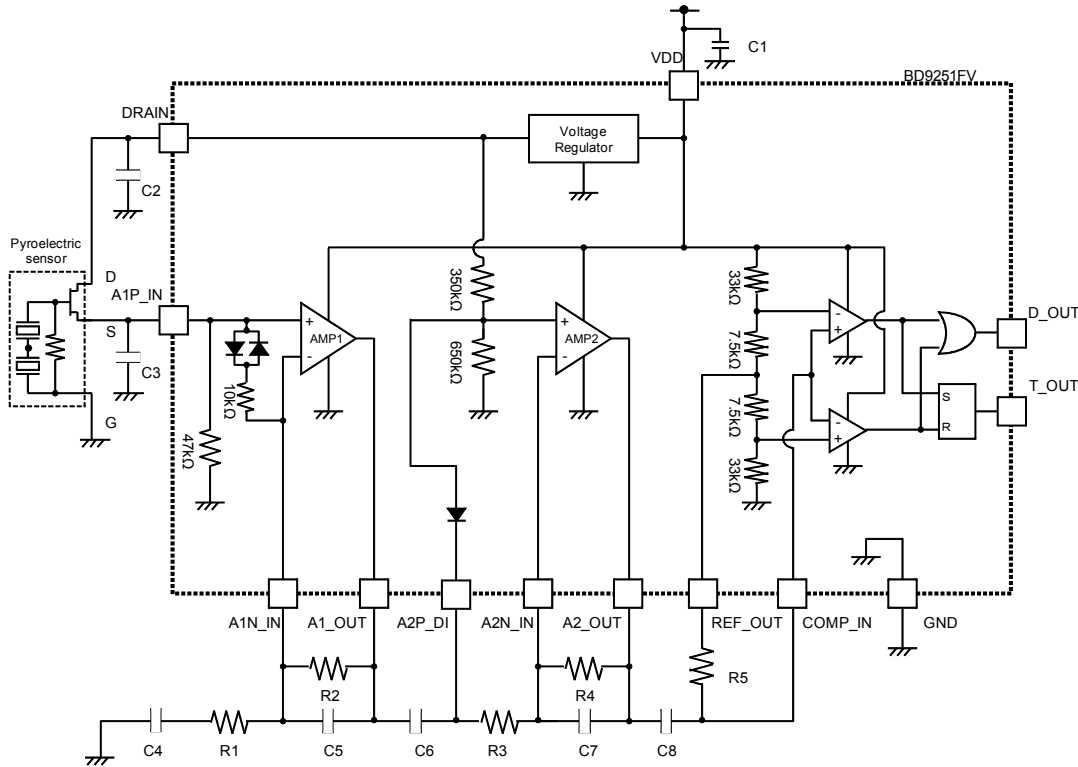

Fig.20 T\_OUT Output High Voltage (source 1mA)

●Block Diagram/Application



※ Please decide the constant after it confirms it enough examining the characteristic and the condition of the pyroelectric sensor.

Example of circuit constant :

- |          |         |       |         |
|----------|---------|-------|---------|
| C1=C2=C3 | : 1uF   | R1=R3 | : 47kΩ  |
| C4=C6    | : 6.9uF | R2=R4 | : 4.7MΩ |
| C5=C7    | : 15nF  | R5    | : 220kΩ |
| C8       | : 10uF  |       |         |

●PIN Description

| PIN No. | PIN Name | Function                                      | Remarks |
|---------|----------|---|---------|
| 1       | GND      | Ground  |         |
| 2       | NC       | NC  |         |
| 3       | DRAIN    | Power supply for pyroelectric infrared sensor |         |
| 4       | A1P_IN   | Sensor input                                  |         |
| 5       | A1N_IN   | Amp1 n-input                                  |         |
| 6       | A1_OUT   | Amp1 output                                   |         |
| 7       | A2P_DI   | Amp2 diode output                             |         |
| 8       | A2N_IN   | Amp2 n-input                                  |         |
| 9       | A2_OUT   | Amp2 output, Analog output                    |         |
| 10      | REF_OUT  | Reference voltage (1/2VDD) output             |         |
| 11      | COMP_IN  | Comparator input                              |         |
| 12      | D_OUT    | Comparator output                             |         |
| 13      | T_OUT    | Moving detection output                       |         |
| 14      | VDD      | Power supply                                  |         |

●Timing chart ( When using dual type pyro sensor )

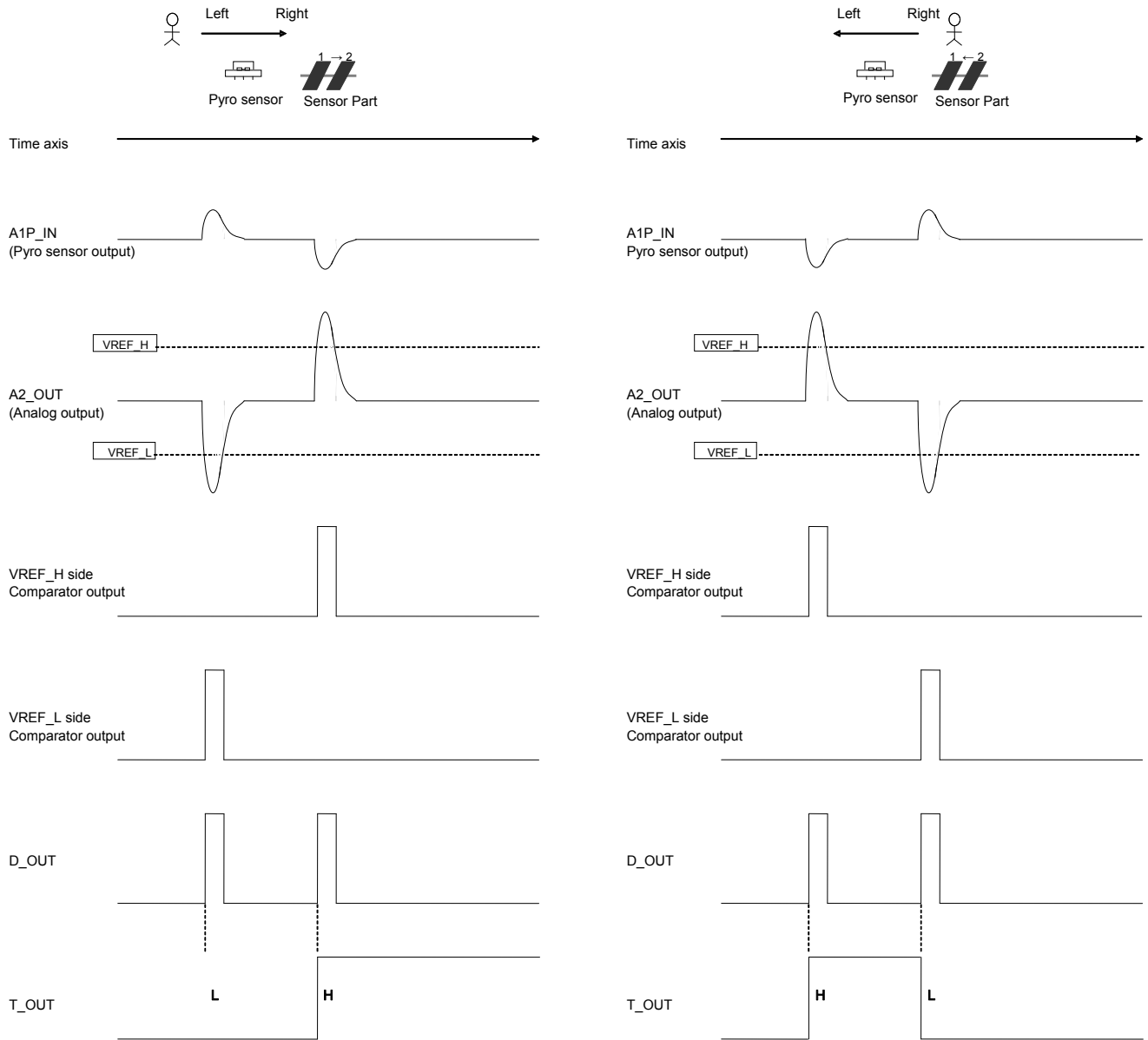

※When using dual type pyro sensor , it's possible to detect the direction of movement by checking the switch of T\_out signal at D\_out=H.

**●Notes for use**

- (1) Absolute maximum ratings  
Use of the IC in excess of absolute maximum ratings such as the applied voltage or operating temperature range may result in IC damage. Assumptions should not be made regarding the state of the IC (short mode or open mode) when such damage is suffered. A physical safety measure such as a fuse should be implemented when use of the IC in a special mode where the absolute maximum ratings may be exceeded is anticipated.
- (2) GND potential  
Ensure a minimum GND pin potential in all operating conditions.
- (3) Short circuit mode between terminals and wrong mounting  
In order to mount the IC on a set PCB, pay thorough attention to the direction and offset of the ICs. Erroneous mounting can destroy the IC. Furthermore, if a short circuit occurs due to foreign matters entering between terminals or between the terminal and the power supply or the GND terminal, the IC can destroy.
- (4) Actions in strong magnetic field  
Use caution when using the IC in the presence of a strong magnetic field as doing so may cause the IC to malfunction.
- (5) Mutual impedance  
Use short and wide wiring tracks for the power supply and ground to keep the mutual impedance as small as possible. Use a capacitor to keep ripple to a minimum.
- (6) About warm-up time  
Operation depends on a power-supply voltage and an external constant for time until stabilizing. Please confirm warm-up time enough when you use it.
- (7) PCB design considerations  
To reduce the noise from OUTPUT to INPUT, COMP\_IN(11pin) and D\_OUT(12pin) and T\_OUT(13pin) lines away from Pyro Sensor and A1P\_IN(4pin).

●Ordering part number

|   |   |
|---|---|
| B | D |
|---|---|

Part No.

|   |   |   |   |
|---|---|---|---|
| 9 | 2 | 5 | 1 |
|---|---|---|---|

Part No.

|   |   |
|---|---|
| F | V |
|---|---|

Package  
FV: SSOP-B14

|   |   |
|---|---|
| E | 2 |
|---|---|

Packaging and forming specification  
E2: Embossed tape and reel

SSOP-B14

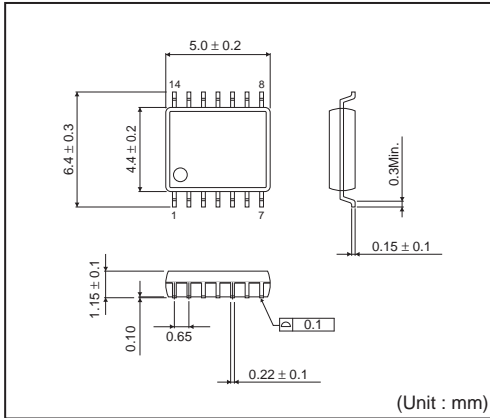

<Tape and Reel information>

|                   |   |
|-------------------|---|
| Tape              | Embossed carrier tape   |
| Quantity          | 2500pcs   |
| Direction of feed | E2<br>( The direction is the 1pin of product is at the upper left when you hold reel on the left hand and you pull out the tape on the right hand ) |

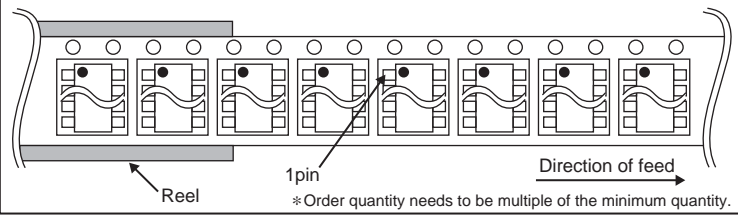



# Notice

## Precaution on using ROHM Products

- Our Products are designed and manufactured for application in ordinary electronic equipments (such as AV equipment, OA equipment, telecommunication equipment, home electronic appliances, amusement equipment, etc.). If you intend to use our Products in devices requiring extremely high reliability (such as medical equipment <sup>(Note 1)</sup>, transport equipment, traffic equipment, aircraft/spacecraft, nuclear power controllers, fuel controllers, car equipment including car accessories, safety devices, etc.) and whose malfunction or failure may cause loss of human life, bodily injury or serious damage to property ("Specific Applications"), please consult with the ROHM sales representative in advance. Unless otherwise agreed in writing by ROHM in advance, ROHM shall not be in any way responsible or liable for any damages, expenses or losses incurred by you or third parties arising from the use of any ROHM's Products for Specific Applications.

(Note1) Medical Equipment Classification of the Specific Applications

| JAPAN     | USA       | EU         | CHINA     |
|-----------|-----------|------------|-----------|
| CLASS III | CLASS III | CLASS II b | CLASS III |
| CLASS IV  |           | CLASS III  |           |

- ROHM designs and manufactures its Products subject to strict quality control system. However, semiconductor products can fail or malfunction at a certain rate. Please be sure to implement, at your own responsibilities, adequate safety measures including but not limited to fail-safe design against the physical injury, damage to any property, which a failure or malfunction of our Products may cause. The following are examples of safety measures:
  - Installation of protection circuits or other protective devices to improve system safety
  - Installation of redundant circuits to reduce the impact of single or multiple circuit failure
- Our Products are designed and manufactured for use under standard conditions and not under any special or extraordinary environments or conditions, as exemplified below. Accordingly, ROHM shall not be in any way responsible or liable for any damages, expenses or losses arising from the use of any ROHM's Products under any special or extraordinary environments or conditions. If you intend to use our Products under any special or extraordinary environments or conditions (as exemplified below), your independent verification and confirmation of product performance, reliability, etc. prior to use, must be necessary:
  - Use of our Products in any types of liquid, including water, oils, chemicals, and organic solvents
  - Use of our Products outdoors or in places where the Products are exposed to direct sunlight or dust
  - Use of our Products in places where the Products are exposed to sea wind or corrosive gases, including Cl<sub>2</sub>, H<sub>2</sub>S, NH<sub>3</sub>, SO<sub>2</sub>, and NO<sub>2</sub>
  - Use of our Products in places where the Products are exposed to static electricity or electromagnetic waves
  - Use of our Products in proximity to heat-producing components, plastic cords, or other flammable items
  - Sealing or coating our Products with resin or other coating materials
  - Use of our Products without cleaning residue of flux (even if you use no-clean type fluxes, cleaning residue of flux is recommended); or Washing our Products by using water or water-soluble cleaning agents for cleaning residue after soldering
  - Use of the Products in places subject to dew condensation
- The Products are not subject to radiation-proof design.
- Please verify and confirm characteristics of the final or mounted products in using the Products.
- In particular, if a transient load (a large amount of load applied in a short period of time, such as pulse. is applied, confirmation of performance characteristics after on-board mounting is strongly recommended. Avoid applying power exceeding normal rated power; exceeding the power rating under steady-state loading condition may negatively affect product performance and reliability.
- De-rate Power Dissipation (Pd) depending on Ambient temperature (Ta). When used in sealed area, confirm the actual ambient temperature.
- Confirm that operation temperature is within the specified range described in the product specification.
- ROHM shall not be in any way responsible or liable for failure induced under deviant condition from what is defined in this document.

## Precaution for Mounting / Circuit board design

- When a highly active halogenous (chlorine, bromine, etc.) flux is used, the residue of flux may negatively affect product performance and reliability.
- In principle, the reflow soldering method must be used; if flow soldering method is preferred, please consult with the ROHM representative in advance.

For details, please refer to ROHM Mounting specification

### Precautions Regarding Application Examples and External Circuits

1. If change is made to the constant of an external circuit, please allow a sufficient margin considering variations of the characteristics of the Products and external components, including transient characteristics, as well as static characteristics.
2. You agree that application notes, reference designs, and associated data and information contained in this document are presented only as guidance for Products use. Therefore, in case you use such information, you are solely responsible for it and you must exercise your own independent verification and judgment in the use of such information contained in this document. ROHM shall not be in any way responsible or liable for any damages, expenses or losses incurred by you or third parties arising from the use of such information.

### Precaution for Electrostatic

This Product is electrostatic sensitive product, which may be damaged due to electrostatic discharge. Please take proper caution in your manufacturing process and storage so that voltage exceeding the Products maximum rating will not be applied to Products. Please take special care under dry condition (e.g. Grounding of human body / equipment / solder iron, isolation from charged objects, setting of ionizer, friction prevention and temperature / humidity control).

### Precaution for Storage / Transportation

1. Product performance and soldered connections may deteriorate if the Products are stored in the places where:
  - [a] the Products are exposed to sea winds or corrosive gases, including Cl<sub>2</sub>, H<sub>2</sub>S, NH<sub>3</sub>, SO<sub>2</sub>, and NO<sub>2</sub>
  - [b] the temperature or humidity exceeds those recommended by ROHM
  - [c] the Products are exposed to direct sunshine or condensation
  - [d] the Products are exposed to high Electrostatic
2. Even under ROHM recommended storage condition, solderability of products out of recommended storage time period may be degraded. It is strongly recommended to confirm solderability before using Products of which storage time is exceeding the recommended storage time period.
3. Store / transport cartons in the correct direction, which is indicated on a carton with a symbol. Otherwise bent leads may occur due to excessive stress applied when dropping of a carton.
4. Use Products within the specified time after opening a humidity barrier bag. Baking is required before using Products of which storage time is exceeding the recommended storage time period.

### Precaution for Product Label

QR code printed on ROHM Products label is for ROHM's internal use only.

### Precaution for Disposition

When disposing Products please dispose them properly using an authorized industry waste company.

### Precaution for Foreign Exchange and Foreign Trade act

Since our Products might fall under controlled goods prescribed by the applicable foreign exchange and foreign trade act, please consult with ROHM representative in case of export.

### Precaution Regarding Intellectual Property Rights

1. All information and data including but not limited to application example contained in this document is for reference only. ROHM does not warrant that foregoing information or data will not infringe any intellectual property rights or any other rights of any third party regarding such information or data. ROHM shall not be in any way responsible or liable for infringement of any intellectual property rights or other damages arising from use of such information or data.:
2. No license, expressly or implied, is granted hereby under any intellectual property rights or other rights of ROHM or any third parties with respect to the information contained in this document.

### Other Precaution

1. This document may not be reprinted or reproduced, in whole or in part, without prior written consent of ROHM.
2. The Products may not be disassembled, converted, modified, reproduced or otherwise changed without prior written consent of ROHM.
3. In no event shall you use in any way whatsoever the Products and the related technical information contained in the Products or this document for any military purposes, including but not limited to, the development of mass-destruction weapons.
4. The proper names of companies or products described in this document are trademarks or registered trademarks of ROHM, its affiliated companies or third parties.

**General Precaution**

1. Before you use our Products, you are requested to carefully read this document and fully understand its contents. ROHM shall not be in any way responsible or liable for failure, malfunction or accident arising from the use of any ROHM's Products against warning, caution or note contained in this document.
2. All information contained in this document is current as of the issuing date and subject to change without any prior notice. Before purchasing or using ROHM's Products, please confirm the latest information with a ROHM sales representative.
3. The information contained in this document is provided on an "as is" basis and ROHM does not warrant that all information contained in this document is accurate and/or error-free. ROHM shall not be in any way responsible or liable for any damages, expenses or losses incurred by you or third parties resulting from inaccuracy or errors of or concerning such information.