

## AS1363 500mA, Low-Dropout Linear Voltage Regulator

### 1 General Description

The AS1363 is a low-dropout linear regulator that operates from a +2.0V to +5.5V supply and delivers a guaranteed 500mA load current with low 150mV dropout.

The device is available in two versions (see Table 1). One version has a high-accuracy output with a preset voltage (1.2, 1.5, 1.8, 3.0, 3.3, or 4.5V). This voltage is internally trimmed and also offers a Bypass pin. With a capacitor connected to this Bypass pin, the PSRR and the Noise performance is improved.

At the other version the output voltage is user-adjustable (1.2V to 5.3V) and offers an SET pin for setting the output voltage.

Table 1. Standard Products

Model	Output Type	BYP	SET
AS1363-AD	Adjustable	No	Yes
AS1363-__	Fixed	Yes	No

A low supply current (65µA typ.) at maximum load is making the device ideal for portable battery-operated equipment.

Other features are included such as an active-low open-drain reset output that indicates when the output is out of regulation, a low-current (30nA typ.) shutdown mode, an integrated short-circuit and a thermal shutdown protection.

The AS1363 is available in a 6-pin SOT23 package.

### 2 Key Features

- Guaranteed Output Current: 500mA
- Low Dropout: 150mV @ 500mA
- 2.0V to 5.5V Input Voltage
- Fixed Output Voltage: 1.2V to 5.0V
- User-Adjustable Output Voltage: 1.2V to 5.3V
- Power OK Output
- Low Quiescent Current: 40µA
- Low Shutdown Current: 30nA
- Thermal Overload Protection
- Output Current Limit
- 6-pin SOT23 Package

### 3 Applications

The device is ideal for laptops, PDAs, portable audio devices, mobile phones, cordless phones, and any other battery-operated portable device.

Figure 1. AS1363 - Typical Application Circuit

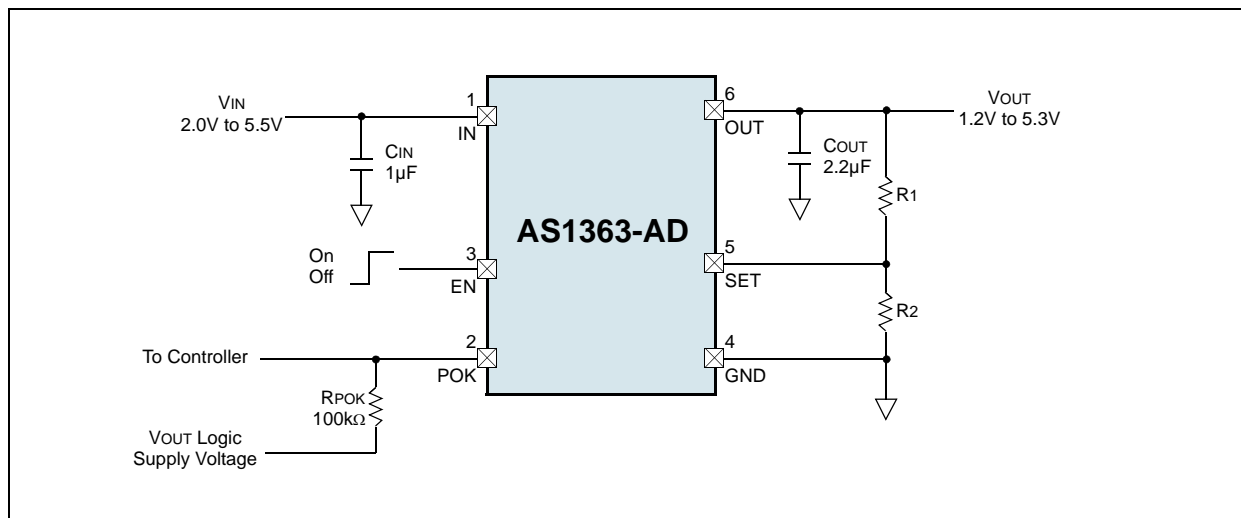

## 4 Pinout

### Pin Assignments

Figure 2. Pin Assignments (Top View)

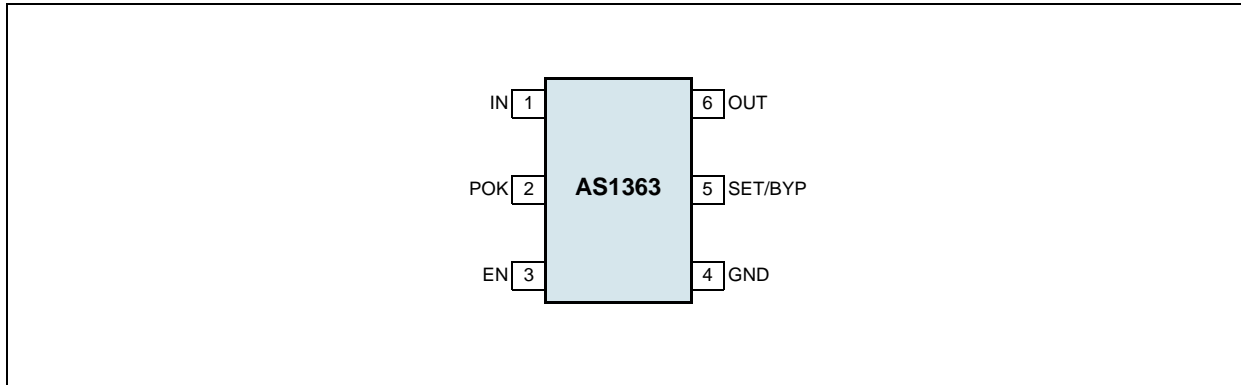

### Pin Descriptions

Table 2. Pin Descriptions

Pin Number	Pin Name	Description
1	IN	<b>+2.0V to +5.5V Supply Voltage.</b> Bypass this pin with a 1 $\mu$ F capacitor to GND (see <a href="#">Capacitor Selection and Regulator Stability on page 11</a> ).
2	POK	<b>Open-Drain POK Output.</b> POK remains low while V <sub>OUT</sub> is below the POK threshold. Connect a 100k $\Omega$ pull-up resistor from this pin to OUT to obtain an output voltage (see <a href="#">Figure 1 on page 1</a> ).
3	EN	<b>Active-High Enable Input.</b> A logic low reduces supply current below 30nA. In shutdown mode, the POK output is low, and OUT is high impedance. Connect this pin to IN for normal operation.
4	GND	<b>Ground</b>
5	SET	<b>Voltage-Setting Input.</b> Connect to GND for preset output or Connect to a resistive voltage-divider between OUT and GND to set the output voltage between 1.2V and 5.3V (see <a href="#">Figure 1 on page 1</a> ).
	BYP	<b>Bypass Pin.</b> Connect a 10nF capacitor from this pin to V <sub>OUT</sub> to improve PSRR and noise performance (see <a href="#">Figure 16 on page 9</a> ).
6	OUT	<b>Output.</b> Sources up to 500mA. Bypass this pin with a 2.2 $\mu$ F low-ESR capacitor to GND (see <a href="#">Figure 1 on page 1</a> ). <b>Note:</b> For output voltages below 2V a 4.7 $\mu$ F capacitor should be used.

## 5 Absolute Maximum Ratings

Stresses beyond those listed in [Table 3](#) may cause permanent damage to the device. These are stress ratings only, and functional operation of the device at these or any other conditions beyond those indicated in [Electrical Characteristics on page 4](#) is not implied. Exposure to absolute maximum rating conditions for extended periods may affect device reliability.

Table 3. Absolute Maximum Ratings

Parameter	Min	Max	Units	Comments
IN, POK, EN, SET/BYP to GND	-0.3	+6	V	
OUT to GND	-0.3	V <sub>IN</sub> +0.3	V	
Output Short-Circuit Duration		1	min	
Continuous Power Dissipation		800	mW	T <sub>AMB</sub> = +70°C; derate 10mW/°C above +70°C
Operating Temperature Range	-40	+85	°C	
Storage Temperature Range	-65	+150	°C	
Junction Temperature		+150	°C	
Package Body Temperature		+260	°C	The reflow peak soldering temperature (body temperature) specified is in accordance with <i>IPC/JEDEC J-STD-020D "Moisture/Reflow Sensitivity Classification for Non-Hermetic Solid State Surface Mount Devices"</i> . The lead finish for Pb-free leaded packages is matte tin (100% Sn).

## 6 Electrical Characteristics

$V_{IN} = V_{OUT(NOM)} + 500mV$  or  $V_{IN} = +2.0V$  (whichever is greater),  $C_{IN} = 1\mu F$ ,  $C_{OUT} = 2.2\mu F$ ,  $EN = IN$ ,  $T_{AMB} = -40$  to  $+85^{\circ}C$  (unless otherwise specified). Typical values are at  $T_{AMB} = +25^{\circ}C$ .

Table 4. Electrical Characteristics

Symbol	Parameter	Condition	Min	Typ	Max	Unit
$V_{IN}$	Input Voltage		2.0		5.5	V
$V_{POR}$	Power On reset	Falling, 100mV hysteresis	1.78	1.87	1.96	V
	Output Voltage Accuracy (Preset Mode)	$I_{OUT} = 100mA$ , $T_{AMB} = +25^{\circ}C$ ,	-0.75		+0.75	%
		$I_{OUT} = 100mA$	-1.5		+1.5	
		$I_{OUT} = 1$ to $500mA$ , $V_{IN} > (V_{OUT} + 0.5V)$ <sup>1</sup>	-2		+2	
$V_{OUT}$	Adjustable Output Voltage Range		1.2		5.3	V
$V_{SET/BYP}$	SET/BYP Voltage Threshold (Adjustable Mode)	$V_{IN} = 2.5V$ , $I_{OUT} = 100mA$ , $V_{OUT}$ set to 2.0V	1.17	1.20	1.23	V
$I_{OUT}$	Guaranteed Output Current (RMS)		500			mA
$I_{LIMIT}$	Short-Circuit Current Limit	$V_{OUT} = 0V$	0.55	0.8	1.2	A
	In-Regulation Current Limit	$V_{OUT} > 96\%$ of nominal value		0.8		A
	SET/BYP Threshold		50	100	150	mV
$I_{SET}$	SET/BYP Input Bias Current	$V_{SET/BYP} = 1.2V$	-100		+100	nA
$I_Q$	Quiescent Current	$I_{OUT} = 100\mu A$		40	150	$\mu A$
		$I_{OUT} = 500mA$		65	200	
$V_{IN} - V_{OUT}$	Dropout Voltage <sup>2</sup>	$I_{OUT} = 500mA$   $V_{OUT} = 2.5V$		150	320	mV
$\Delta V_{LNR}$	Line Regulation	$V_{IN}$ from $(V_{OUT} + 100mV)$ to 5.5V, $I_{LOAD} = 5mA$	-0.125		+0.125	%/V
$\Delta V_{LDR}$	Load Regulation	$I_{OUT} = 1$ to $500mA$	-0.001		+0.001	%/mA
PSRR	Ripple Rejection	$f = 1kHz$ , $I_{OUT} = 10mA$ , adjustable Output		65		dB
		$f = 10kHz$ , $I_{OUT} = 10mA$ , adjustable Output		70		
		$f = 100kHz$ , $I_{OUT} = 10mA$ , adjustable Output		60		
	Output Voltage Noise	10Hz to 100kHz, $I_{OUT} = 10mA$ , adjustable Output		80		$\mu VRMS$
		100Hz to 100kHz, $I_{OUT} = 10mA$ , adjustable Output		65		
<b>Shutdown</b>						
$I_{OFF}$	Shutdown Supply Current	$EN = GND$ , $V_{IN} = 5.5V$ , $T_{AMB} = 25^{\circ}C$		0.03	0.5	$\mu A$
		$EN = GND$ , $V_{IN} = 5.5V$			15	
$V_{IH}$	EN Input Threshold	$2.0V < V_{IN} < 5.5V$	1.6			V
$V_{IL}$		$2.0V < V_{IN} < 5.5V$			0.6	V
$I_{EN}$	EN Input Bias Current	$EN = IN$ or $GND$ , $T_{AMB} = +25^{\circ}C$		1		nA
		$T_{AMB} = +85^{\circ}C$		5		

Table 4. Electrical Characteristics (Continued)

Symbol	Parameter	Condition	Min	Typ	Max	Unit
<b>POK Output</b>						
V <sub>OL</sub>	POK Output Low Voltage	POK sinking 1mA		0.05	0.25	V
	Operating Voltage Range for Valid POK Signal	POK sinking 100 $\mu$ A	1.1		5.5	V
	POK Output High leakage Current	POK = 5.5V, T <sub>AMB</sub> = +25 $^{\circ}$ C		1		nA
		T <sub>AMB</sub> = +85 $^{\circ}$ C		5		
	POK Threshold	Rising edge (referenced to V <sub>OUT(NOM)</sub> )	90	94	98	%
<b>Thermal Protection</b>						
T <sub>SHDNN</sub>	Thermal Shutdown Temperature			170		$^{\circ}$ C
$\Delta$ T <sub>SHDNN</sub>	Thermal Shutdown Hysteresis			20		$^{\circ}$ C

1. Guaranteed by production test of load regulation and line regulation.
2. Dropout voltage is defined as  $V_{IN} - V_{OUT}$ , when  $V_{OUT}$  is 100mV below the value of  $V_{OUT}$  measured for  $V_{IN} = (V_{OUT(NOM)} + 500mV)$ . Since the minimum input voltage is 2.0V, this specification is only valid when  $V_{OUT(NOM)} > 2.0V$ .

**Note:** All limits are guaranteed. The parameters with min and max values are guaranteed with production tests or SQC (Statistical Quality Control) methods.

## 7 Typical Operating Characteristics

$V_{IN} = V_{OUT(NOM)} + 0.5V$ ,  $C_{IN} = 1\mu F$ ,  $C_{OUT} = 2.2\mu F$ ,  $T_{AMB} = 25^{\circ}C$  (unless otherwise specified).

Figure 3.  $V_{DROP}$  vs.  $I_{OUT}$ ;

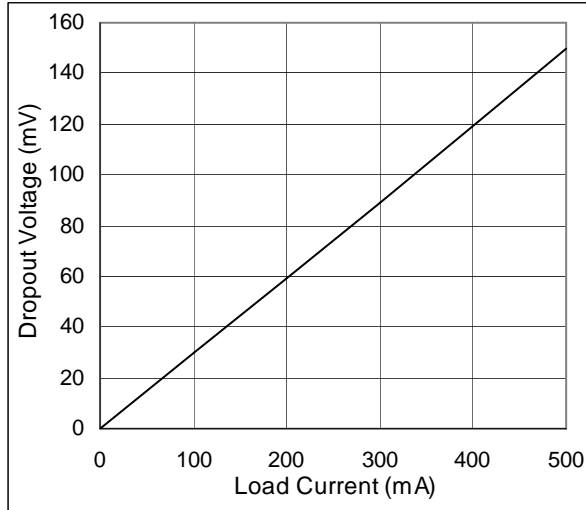

Figure 4.  $V_{OUT}$  vs.  $I_{OUT}$ ;  $V_{OUT(NOM)} = 2.5V$

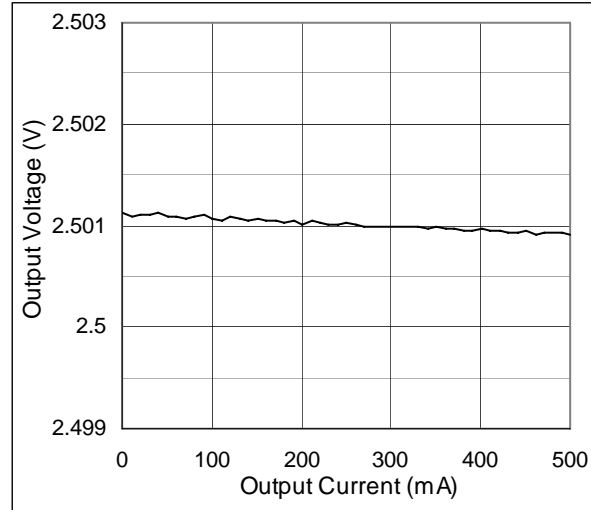

Figure 5.  $V_{OUT}$  vs. Temperature;  $V_{OUT(NOM)} = 2.5V$

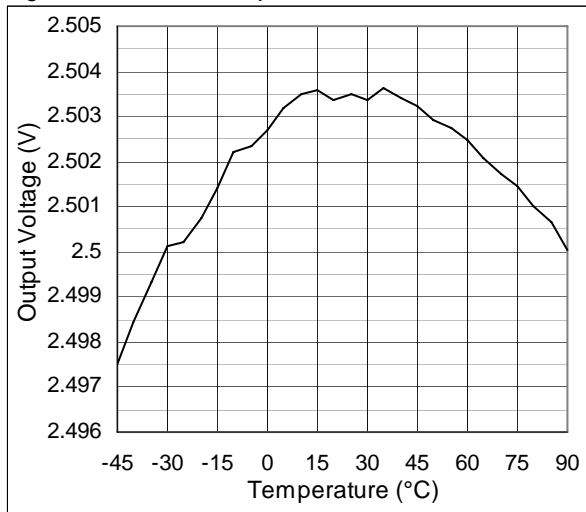

Figure 6.  $V_{OUT}$  vs.  $V_{IN}$ ;  $V_{OUT(NOM)} = 2.5V$

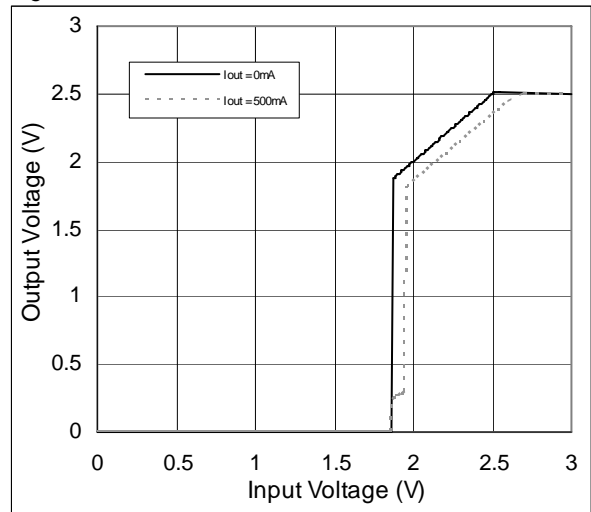

Figure 7. Quiescent Current vs.  $V_{IN}$ ; no load

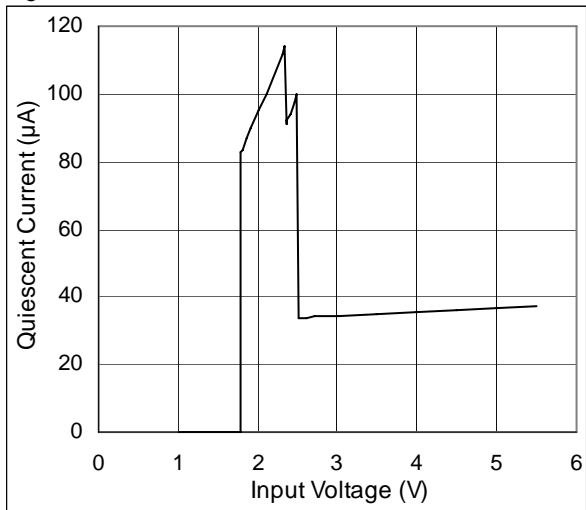

Figure 8. Quiescent Current vs.  $I_{OUT}$ ;  $V_{IN} = 3.0V$ ;

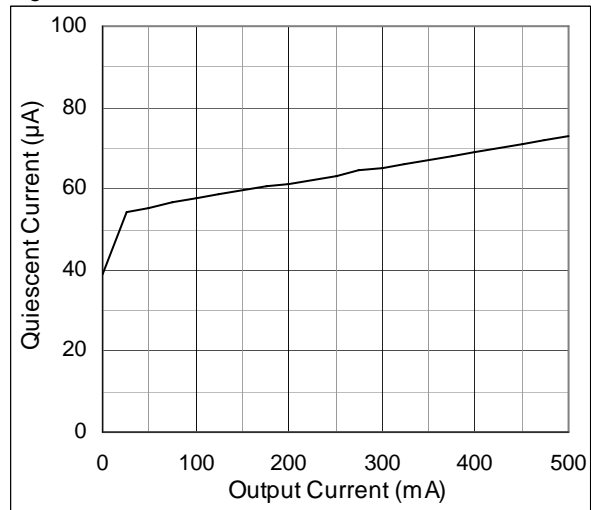

Figure 9. Quiescent Current vs. Temperature;  $V_{IN} = 3.0V$

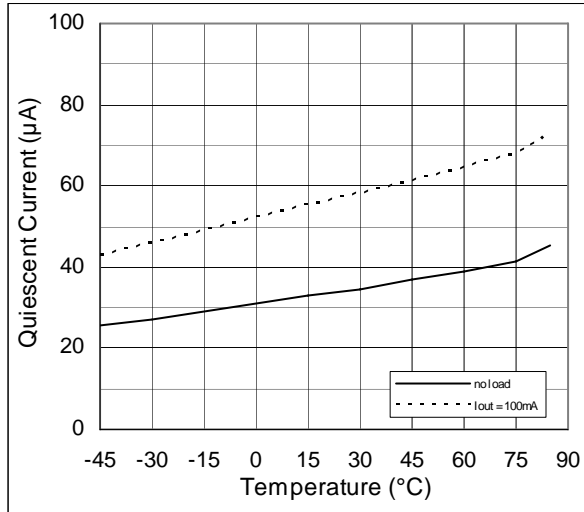

Figure 10. PSRR vs. Frequency;  $I_{OUT} = 10mA$ ,  $C_{IN} = 68nF$ ,

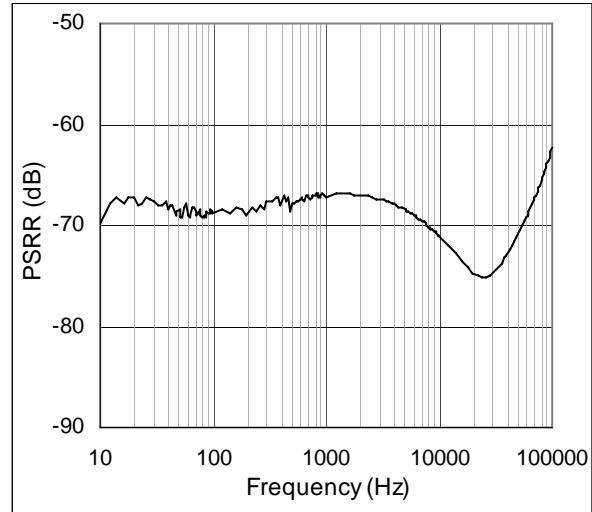

Figure 11. Line Transient Response;  $V_{IN} = 3.0V$  to  $3.5V$ ,  $I_{OUT} = 100mA$

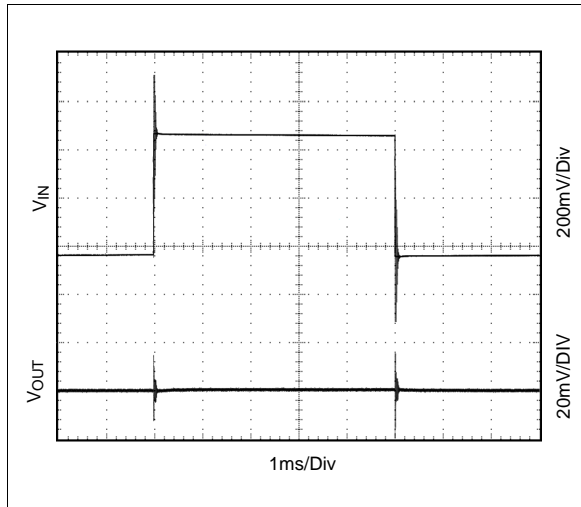

Figure 12. Load Transient Response;  $V_{IN} = 3.0V$ ,  $I_{OUT} = 50mA$  to  $250mA$

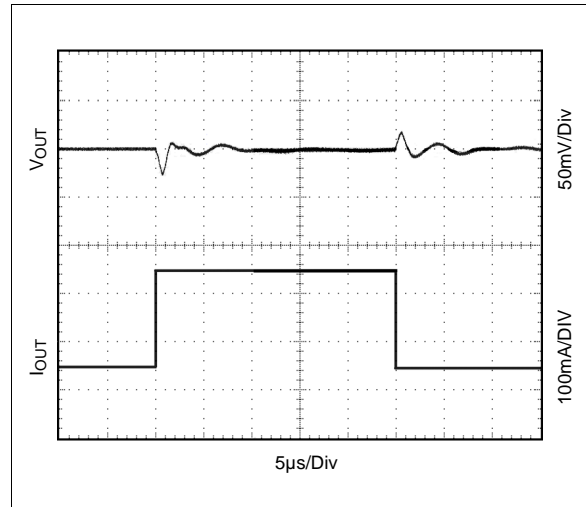

Figure 13. Startup;  $V_{IN} = 3.0V$ ,  $I_{OUT} = 100mA$

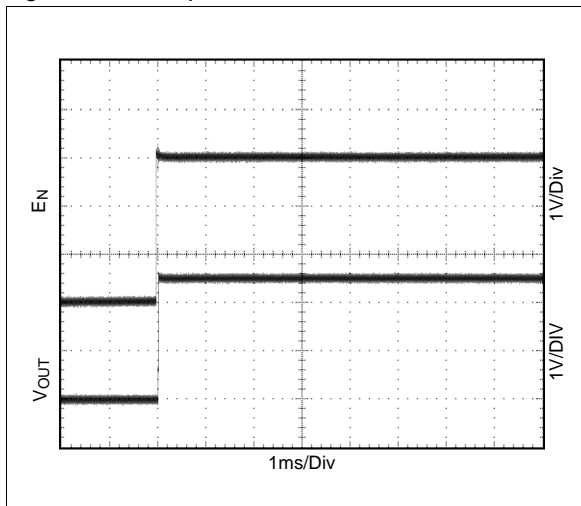
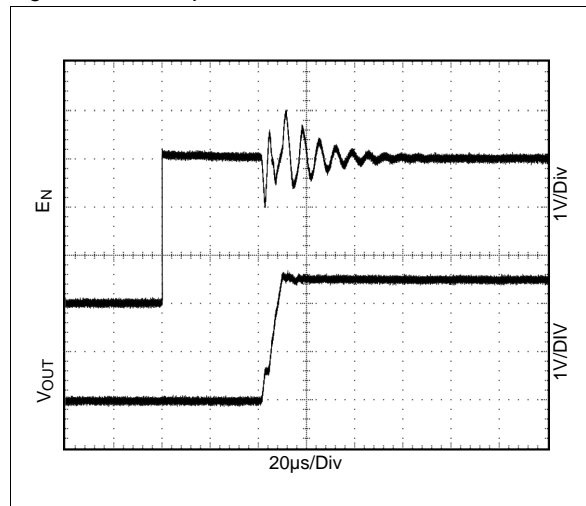

Figure 14. Startup;  $V_{IN} = 3.0V$ ,  $I_{OUT} = 100mA$



## 8 Detailed Description

The AS1363 is a low-dropout, low-quiescent-current linear regulator specifically designed for battery-powered devices. The regulator supplies loads of up to 500mA and can deliver a factory-preset output voltage or user-adjustable output voltage.

The device features a 1.2V reference, error amplifier, P-channel pass transistor, and internal feedback voltage-divider (see Figure 15). Additional blocks include an output current limiter, thermal sensor, and shutdown logic.

Figure 15. Block Diagram

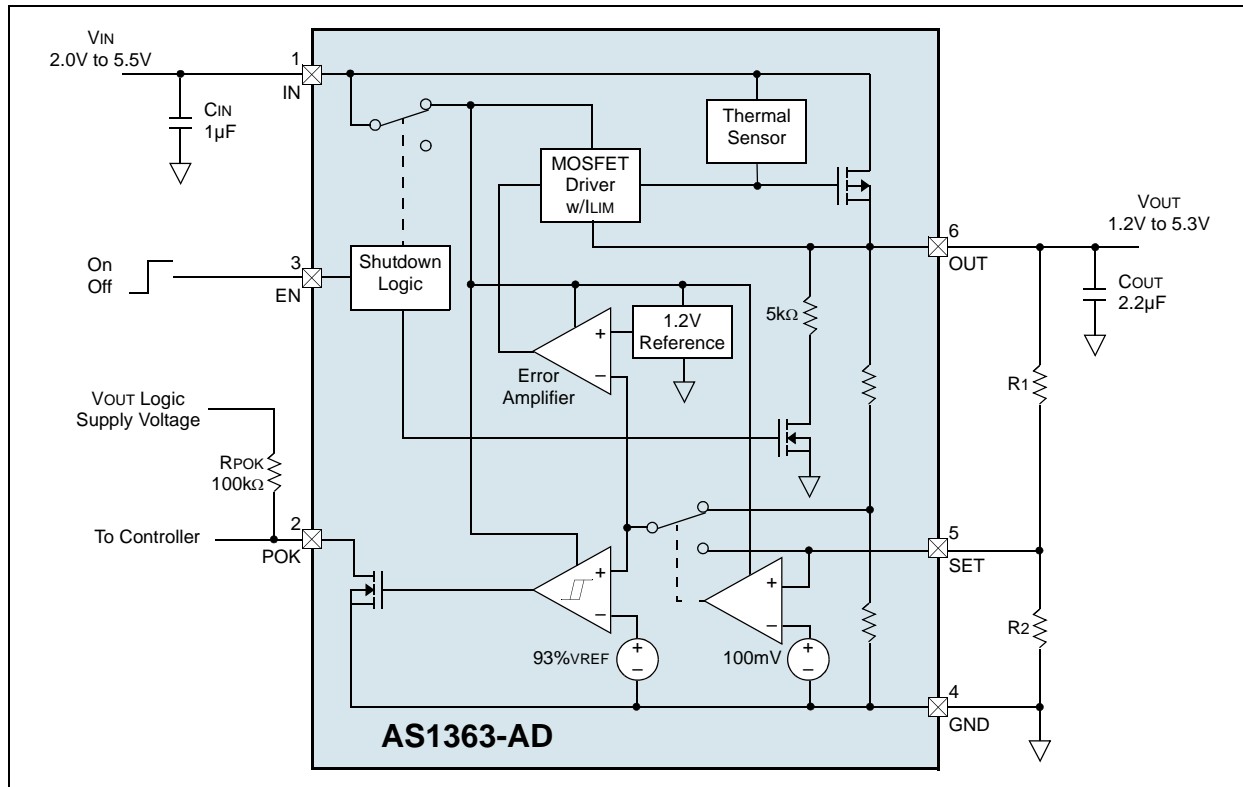

The 1.2V reference is connected to the error amplifier, which compares this reference with the feedback voltage and amplifies the difference. If the feedback voltage is lower than the reference voltage, the pass-transistor gate is pulled lower, allowing more current to pass to the output and increases the output voltage. If the feedback voltage is too high, the pass transistor gate is pulled up, allowing less current to pass to the output.

The output voltage is delivered back through either an internal resistive divider connected to OUT or an external resistive network connected to SET (see Figure 15). The comparator examines  $V_{SET/BYP}$  and selects the feedback path. If  $V_{SET/BYP}$  is less than 50mV, the internal feedback path is used and the output is regulated to the factory-preset voltage (see Ordering Information on page 13).

### Internal P-Channel Pass Transistor

The AS1363 features a P-channel MOSFET pass transistor and consumes only a maximum of 200µA of quiescent current under heavy loads as well as in dropout.

### Shutdown

If pin EN is connected to GND the AS1363 is disabled. In shutdown mode all internal circuits are turned off, reducing supply current to 30nA (typ.). For normal operation pin EN must be connected to IN. During shutdown, POK is low.



## Output Voltage Selection

The AS1363 is available in two versions (see [Ordering Information on page 13](#)). One version can only operate at one fixed output voltage and the other version can operate with a preset output voltage or with user-adjustable output voltages (1.2V to 5.3V).

- For the fixed output voltage version connect a capacitor  $C_{BYP}$  from pin  $BYP$  to  $V_{OUT}$  to improve PSRR and Noise performance (see [Figure 16](#)).
- To use the factory preset output voltage of the user-adjustable output voltage version, connect pin  $SET$  to  $GND$  (see [Figure 17](#)).
- For configurations using an output voltage other than the factory preset, a voltage-divider from  $OUT$  to  $SET$  to  $GND$  is required, as shown in (see [Figure 1 on page 1](#)). A value for  $R_2$  in the 25k $\Omega$  to 100k $\Omega$  range should be sufficient. Calculate the value for  $R_1$  as:

$$R_1 = R_2 \times \left( \frac{V_{OUT}}{V_{SET/BYP}} - 1 \right) \quad (EQ 1)$$

### Where:

$V_{OUT}$  is in a range from 1.2V to 5.3V.

$V_{SET/BYP} = 1.2V$ .

Figure 16. Fixed Output Voltage

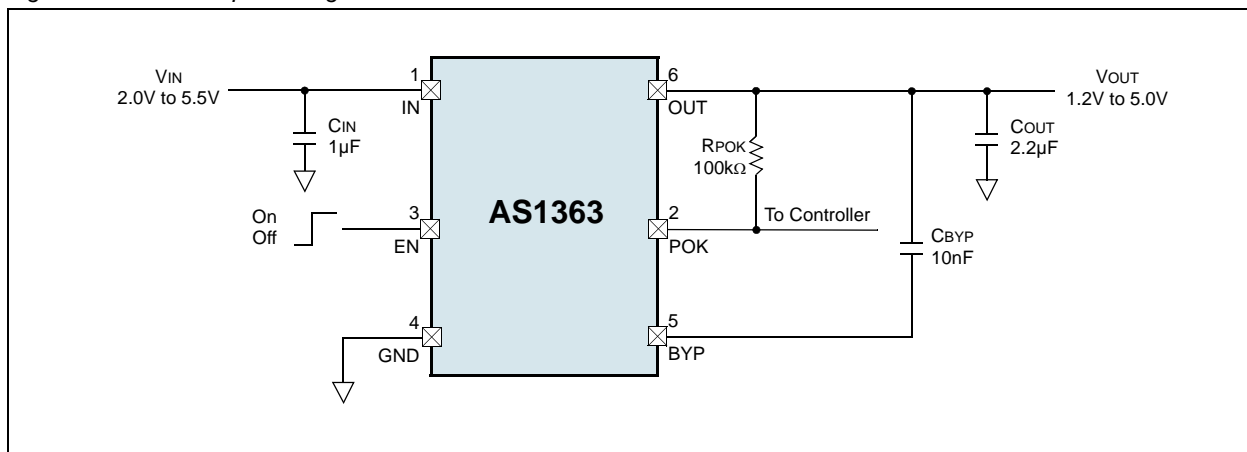
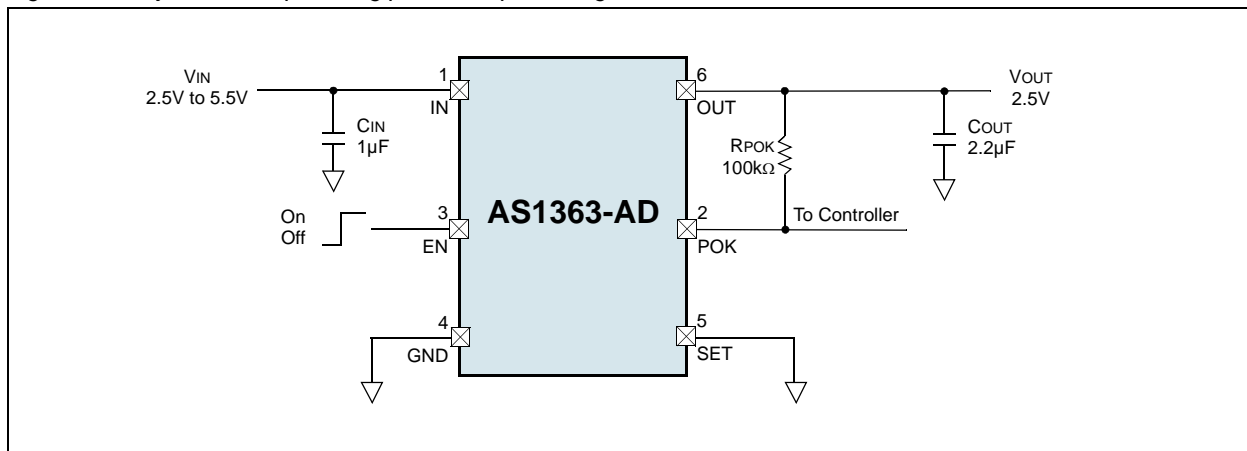

Figure 17. Adjustable Output using preset Output Voltage



## Power-OK

The AS1363 features a power-ok indicator that asserts when the output voltage falls out of regulation. The open-drain POK output goes low when output voltage at OUT falls 6% below its nominal value. A 100kΩ pull-up resistor from POK to a (typically OUT) provides a logic control signal.

POK can be used as a power-on-reset (POR) signal to a microcontroller or can drive an external LED to indicate a power failure condition.

**Note:** POK is low during shutdown.

## Current Limit

The AS1363 features current limiting circuitry that monitors the pass transistor, limiting short-circuit output current to 0.8A (typ). The circuitry of the AS1363 allows that the output can be shorted to ground for an indefinite period of time without damaging the device.

## Thermal Overload Protection

Integrated thermal overload protection limits the total power dissipation in the AS1363. When the junction temperature (T<sub>J</sub>) exceeds +170°C typically, the pass transistor is turned off. Normal operation is continued when T<sub>J</sub> drops approximately 20°C.

**Note:** Regardless of the hysteresis, continuous short-circuit condition will result in a pulsed output.

## Operating Region and Power Dissipation

Maximum power dissipation depends on the thermal resistance of the IC package and circuit board, the temperature difference between the die junction and ambient air, and the rate of air flow.

The power dissipated in the device is given as:

$$PD = I_{OUT} \times (V_{IN} - V_{OUT}) \quad (EQ 2)$$

The AS1363 can deliver up to 0.5A RMS and operates with input voltages up to +5.5V, but not at the same time. High output currents can only be sustained when input/output differential voltages are low.

The maximum allowed power dissipation is 800mW at T<sub>AMB</sub> = +70°C or:

$$PDMAX = \frac{T_{J(max)} - T_{AMB}}{\theta_{JC} + \theta_{JA}} \quad (EQ 3)$$

### Where:

T<sub>J(max)</sub> - T<sub>AMB</sub> is the temperature difference between the device die junction and the surrounding air.

θ<sub>JC</sub> is the thermal resistance of the junction to the case.

θ<sub>JA</sub> is the thermal resistance from the case through the PCB, copper traces, and other materials to the surrounding air.

**Note:** For best heat transfer, the copper area should be equally shared between the IN, OUT, and GND pins.

## 9 Application Information

### Capacitor Selection and Regulator Stability

Input and output capacitors are required for stable operation of the AS1363 over the full temperature range and with load currents up to 500mA. Connect  $C_{IN}$  and  $C_{OUT}$  as close to the AS1363 as possible to minimize the impact of PC board trace inductance.

For  $C_{IN}$ , connect a 1 $\mu$ F capacitor between IN and ground.  $C_{IN}$  lowers the source impedance of the input supply. Reduce noise and improve load-transient response, stability, and power supply rejection by using larger output capacitors, such as 10 $\mu$ F.

For  $C_{OUT}$  connect a 2.2 $\mu$ F low-ESR capacitor between OUT and ground. The output capacitor's ESR affects stability and output noise. Use output capacitors with an ESR of 0.1 $\Omega$  or less to ensure stability and optimum transient response. Surface-mount ceramic capacitors have very-low ESR and are commonly available in values up to 10 $\mu$ F.

For output voltages less than 2V, use a 4.7 $\mu$ F low-ESR output capacitor for  $C_{OUT}$ .

### Noise, Power Supply Rejection Ratio, and Transient Response

The AS1363 is designed to operate with low dropout voltages and low quiescent currents in battery-powered systems while still maintaining good noise response, transient response, and AC rejection. See [Typical Operating Characteristics on page 6](#) for a plot of power-supply rejection ratio (PSRR) versus frequency. When operating from noisy sources, improved supply-noise rejection and transient response can be achieved by increasing the values of the input and output bypass capacitors and through passive filtering techniques.

### Dropout Voltage

Because the AS1363 uses a P-channel MOSFET pass transistor, its dropout voltage is a function of drain-to-source on-resistance ( $R_{DS(ON)}$ ) multiplied by the load current:

$$V_{DROPOUT} = V_{IN} - V_{OUT} = R_{DS(ON)} \times I_{OUT} \quad (\text{EQ 4})$$

**Note:** The AS1363 ground current remains below 200 $\mu$ A in dropout.

## 10 Package Drawings and Markings

The device is available in an 6-pin SOT23 package.

Figure 18. 6-pin SOT23 Package

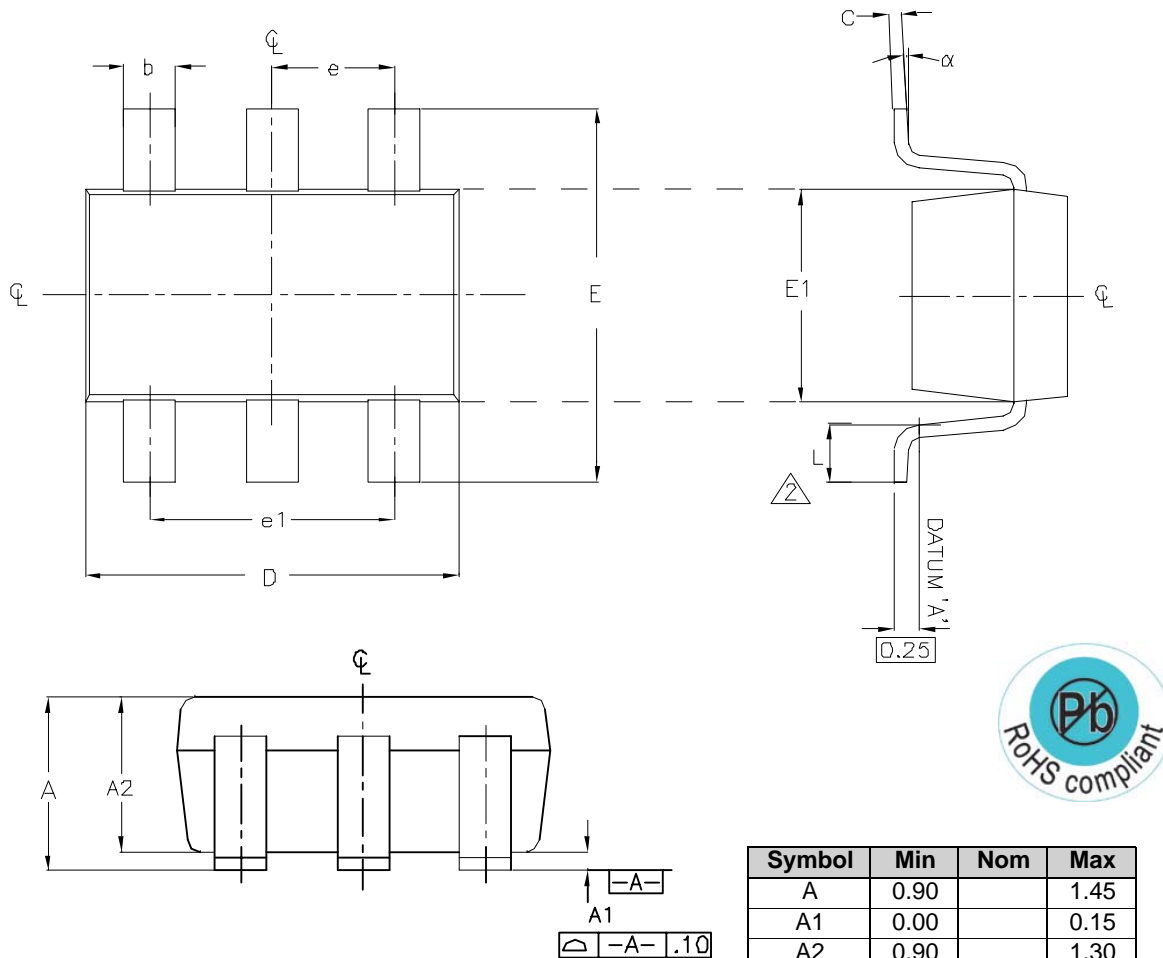

### Notes:

1. Dimensions are in millimeters (mm).
2. Foot length measured at intercept point between datum A and lead surface.
3. Package outline exclusive of mold flash and metal burr.
4. Package outline inclusive of solder plating.
5. Complies with EIAJ SC74A.

Symbol	Min	Nom	Max
A	0.90		1.45
A1	0.00		0.15
A2	0.90		1.30
b	0.30		0.50
C	0.09		0.20
D	2.80		3.05
E	2.60		3.00
E1	1.50		1.75
L	0.30		0.55
E	0.95Ref		
e1	1.90Ref		
$\alpha$	0°		8°

## 11 Ordering Information

The device is available as the standard products shown in [Table 5](#).

Table 5. Ordering Information

Ordering Code	Marking	Output	SET/BYP	Delivery Form	Package
AS1363-BSTT-AD	ASQ9	adjustable (preset to 2.5V)	SET	Tape and Reel	6-pin SOT23
AS1363-BSTT-12*	ASRY	1.2V	BYP	Tape and Reel	6-pin SOT23
AS1363-BSTT-15	ASRA	1.5V	BYP	Tape and Reel	6-pin SOT23
AS1363-BSTT-18	ASRB	1.8V	BYP	Tape and Reel	6-pin SOT23
AS1363-BSTT-30	ASRC	3.0V	BYP	Tape and Reel	6-pin SOT23
AS1363-BSTT-33	ASRD	3.3V	BYP	Tape and Reel	6-pin SOT23
AS1363-BSTT-45	ASRE	4.5V	BYP	Tape and Reel	6-pin SOT23

\*Future product.

Non-standard devices are available between 1.4V and 4.6V in 50mV steps and between 4.6V and 5.0V in 100mV steps. For more information and inquiries contact <http://www.austriamicrosystems.com/contact>

**Note:** All products are RoHS compliant.

Buy our products or get free samples online at ICdirect: <http://www.austriamicrosystems.com/ICdirect>

Technical Support is found at <http://www.austriamicrosystems.com/Technical-Support>

For further information and requests, please contact us <mailto:sales@austriamicrosystems.com> or find your local distributor at <http://www.austriamicrosystems.com/distributor>

## Copyrights

Copyright © 1997-2010, austriamicrosystems AG, Tobelbaderstrasse 30, 8141 Unterpremstaetten, Austria-Europe. Trademarks Registered ®. All rights reserved. The material herein may not be reproduced, adapted, merged, translated, stored, or used without the prior written consent of the copyright owner.

All products and companies mentioned are trademarks or registered trademarks of their respective companies.

## Disclaimer

Devices sold by austriamicrosystems AG are covered by the warranty and patent indemnification provisions appearing in its Term of Sale. austriamicrosystems AG makes no warranty, express, statutory, implied, or by description regarding the information set forth herein or regarding the freedom of the described devices from patent infringement. austriamicrosystems AG reserves the right to change specifications and prices at any time and without notice. Therefore, prior to designing this product into a system, it is necessary to check with austriamicrosystems AG for current information. This product is intended for use in normal commercial applications. Applications requiring extended temperature range, unusual environmental requirements, or high reliability applications, such as military, medical life-support or life-sustaining equipment are specifically not recommended without additional processing by austriamicrosystems AG for each application. For shipments of less than 100 parts the manufacturing flow might show deviations from the standard production flow, such as test flow or test location.

The information furnished here by austriamicrosystems AG is believed to be correct and accurate. However, austriamicrosystems AG shall not be liable to recipient or any third party for any damages, including but not limited to personal injury, property damage, loss of profits, loss of use, interruption of business or indirect, special, incidental or consequential damages, of any kind, in connection with or arising out of the furnishing, performance or use of the technical data herein. No obligation or liability to recipient or any third party shall arise or flow out of austriamicrosystems AG rendering of technical or other services.



## Contact Information

### Headquarters

austriamicrosystems AG  
Tobelbaderstrasse 30  
A-8141 Unterpremstaetten, Austria

Tel: +43 (0) 3136 500 0  
Fax: +43 (0) 3136 525 01

For Sales Offices, Distributors and Representatives, please visit:

<http://www.austriamicrosystems.com/contact>