

SyncFET™ – N-Channel, POWERTRENCH®

30 V, 21 A, 4.4 mΩ

FDMC0310AS, FDMC0310AS-F127

General Description

The FDMC0310AS has been designed to minimize losses in power conversion application. Advancements in both silicon and package technologies have been combined to offer the lowest $r_{DS(on)}$ while maintaining excellent switching performance. This device has the added benefit of an efficient monolithic schottky body diode.

Features

- Max $r_{DS(on)}$ = 4.4 mΩ at $V_{GS} = 10\text{ V}$, $I_D = 19\text{ A}$
- Max $r_{DS(on)}$ = 5.2 mΩ at $V_{GS} = 4.5\text{ V}$, $I_D = 17.5\text{ A}$
- Advanced Package and Silicon Combination for Low $r_{DS(on)}$ and High Efficiency
- SyncFET Schottky Body Diode
- MSL1 Robust Package Design
- 100% UIL Tested
- These Devices are Pb-Free and are RoHS Compliant

Applications

- Synchronous Rectifier for DC/DC Converters
- Notebook Vcore/GPU Low Side Switch
- Networking Point of Load Low Side Switch
- Telecom Secondary Side Rectification

| $V_{DS}\text{ MAX}$ | $r_{DS(on)}\text{ MAX}$ | $I_D\text{ MAX}$ |
|---------------------|-------------------------|------------------|
| 30 V | 4.4 mΩ @ 10 V | 21 A |
| | 5.2 mΩ @ 4.5 V | |

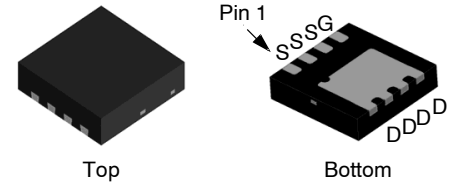

WDFN8 3.3x3.3, 0.65P
(MLP SAWN)
CASE 511DH

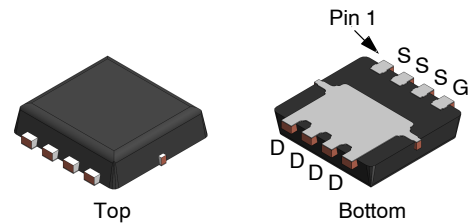

WDFN8 3.3x3.3, 0.65P
(MLP PUNCH)
CASE 511DQ - Option C

MARKING DIAGRAM

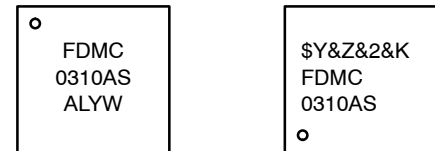

FDMC0310AS = Device Code
A = Assembly Site
L = Wafer Lot Number
YW = Assembly Start Week
\$Y = onsemi Logo
&Z = Assembly Plant Code
&2 = Numeric Date Code
&K = Lot Code

PIN CONNECTIONS

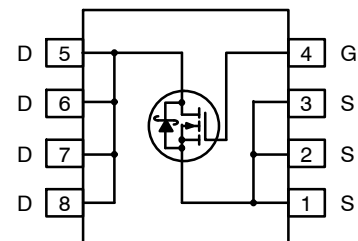

ORDERING INFORMATION

See detailed ordering and shipping information on page 7 of this data sheet.

FDMC0310AS, FDMC0310AS-F127

MOSFET MAXIMUM RATINGS ($T_A = 25^\circ\text{C}$ unless otherwise noted)

| Symbol | Parameter | Ratings | Unit |
|----------------|--|--|------------------|
| V_{DS} | Drain to Source Voltage | 30 | V |
| V_{DSst} | Drain to Source Transient Voltage ($t_{\text{Transient}} < 100$ ns) | 33 | V |
| V_{GS} | Gate to Source Voltage (Note 1) | ± 20 | V |
| I_D | Drain Current | Continuous, $T_C = 25^\circ\text{C}$ | 21 |
| | | Continuous, $T_A = 25^\circ\text{C}$ (Note 3a) | 19 |
| | | Pulsed | 100 |
| E_{AS} | Single Pulse Avalanche Energy (Note 2) | 66 | mJ |
| P_D | Power Dissipation | $T_C = 25^\circ\text{C}$ | 36 |
| | | $T_A = 25^\circ\text{C}$ (Note 3a) | 2.4 |
| T_J, T_{STG} | Operating and Storage Junction Temperature Range | -55 to $+150$ | $^\circ\text{C}$ |

Stresses exceeding those listed in the Maximum Ratings table may damage the device. If any of these limits are exceeded, device functionality should not be assumed, damage may occur and reliability may be affected.

- As an N-ch device, the negative V_{GS} rating is for low duty cycle pulse occurrence only. No continuous rating is implied.
- E_{AS} of 66 mJ is based on starting $T_J = 25^\circ\text{C}$, $L = 0.3$ mH, $I_{AS} = 21$ A, $V_{DD} = 27$ V, $V_{GS} = 10$ V. 100% tested at $L = 3$ mH, $I_{AS} = 10.2$ A.

THERMAL CHARACTERISTICS

| Symbol | Parameter | Ratings | Unit |
|-----------------|---|---------|---------------------------|
| $R_{\theta JC}$ | Thermal Resistance, Junction to Case | 3.4 | $^\circ\text{C}/\text{W}$ |
| $R_{\theta JA}$ | Thermal Resistance, Junction to Ambient (Note 3a) | 53 | |

- $R_{\theta JA}$ is determined with the device mounted on a 1 in² pad 2 oz copper pad on a 1.5 x 1.5 in. board of FR-4 material. $R_{\theta JC}$ is guaranteed by design while $R_{\theta CA}$ is determined by the user's board design.

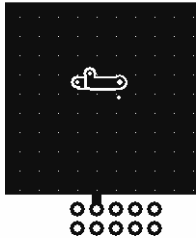

- 53 $^\circ\text{C}/\text{W}$ when mounted on a 1 in² pad of 2 oz copper.



- 125 $^\circ\text{C}/\text{W}$ when mounted on a minimum pad of 2 oz copper.

FDMC0310AS, FDMC0310AS-F127

ELECTRICAL CHARACTERISTICS (T_J = 25°C unless otherwise noted)

| Symbol | Parameter | Test Conditions | Min | Typ | Max | Unit |
|--------|-----------|-----------------|-----|-----|-----|------|
|--------|-----------|-----------------|-----|-----|-----|------|

OFF CHARACTERISTICS

| | | | | | | |
|--------------------------------------|---|---|----|----|-----|-------|
| BV _{DSS} | Drain to Source Breakdown Voltage | I _D = 1 mA, V _{GS} = 0 V | 30 | – | – | V |
| $\frac{\Delta BV_{DSS}}{\Delta T_J}$ | Breakdown Voltage Temperature Coefficient | I _D = 10 mA, referenced to 25°C | – | 26 | – | mV/°C |
| I _{DSS} | Zero Gate Voltage Drain Current | V _{DS} = 24 V, V _{GS} = 0 V | – | – | 500 | μA |
| I _{GSS} | Gate to Source Leakage Current, Forward | V _{GS} = 20 V, V _{DS} = 0 V | – | – | 100 | nA |

ON CHARACTERISTICS

| | | | | | | |
|--|--|---|-----|-----|-----|-------|
| V _{GS(th)} | Gate to Source Threshold Voltage | V _{GS} = V _{DS} , I _D = 1 mA | 1.2 | 1.6 | 3.0 | V |
| $\frac{\Delta V_{GS(th)}}{\Delta T_J}$ | Gate to Source Threshold Voltage Temperature Coefficient | I _D = 10 mA, referenced to 25°C | – | –5 | – | mV/°C |
| r _{DS(on)} | Static Drain to Source On Resistance | V _{GS} = 10 V, I _D = 19 A | – | 3.8 | 4.4 | mΩ |
| | | V _{GS} = 4.5 V, I _D = 17.5 A | – | 4.5 | 5.2 | |
| | | V _{GS} = 10 V, I _D = 19 A, T _J = 125°C | – | 4.5 | 5.8 | |
| g _{FS} | Forward Transconductance | V _{DS} = 5 V, I _D = 19 A | – | 106 | – | S |

DYNAMIC CHARACTERISTICS

| | | | | | | |
|------------------|------------------------------|--|-----|------|------|----|
| C _{iss} | Input Capacitance | V _{DS} = 15 V, V _{GS} = 0 V, f = 1 MHz | – | 2380 | 3165 | pF |
| C _{oss} | Output Capacitance | | – | 885 | 1175 | pF |
| C _{rss} | Reverse Transfer Capacitance | | – | 100 | 150 | pF |
| R _g | Gate Resistance | | 0.1 | 0.7 | 2.5 | Ω |

SWITCHING CHARACTERISTICS

| | | | | | | |
|---------------------|-------------------------------|---|---|----|----|----|
| t _{d(on)} | Turn-On Delay Time | V _{DD} = 15 V, I _D = 19 A V _{GS} = 10 V, R _{GEN} = 6 Ω | – | 11 | 20 | ns |
| t _r | Rise Time | | – | 5 | 10 | ns |
| t _{d(off)} | Turn-Off Delay Time | | – | 30 | 48 | ns |
| t _f | Fall Time | | – | 4 | 10 | ns |
| Q _g | Total Gate Charge | V _{GS} = 0 V to 10 V V _{DD} = 15 V, I _D = 19 A | – | 37 | 52 | nC |
| | | V _{GS} = 0 V to 4.5 V V _{DD} = 15 V, I _D = 19 A | – | 18 | 25 | nC |
| Q _{gs} | Gate to Source Charge | V _{DD} = 15 V, I _D = 19 A | – | 6 | – | nC |
| Q _{gd} | Gate to Drain "Miller" Charge | | – | 6 | – | nC |

DRAIN-SOURCE DIODE CHARACTERISTICS

| | | | | | | |
|-----------------|---------------------------------------|---|---|-----|-----|----|
| V _{SD} | Source to Drain Diode Forward Voltage | V _{GS} = 0 V, I _S = 2 A (Note 4) | – | 0.6 | 0.8 | V |
| | | V _{GS} = 0 V, I _S = 19 A (Note 4) | – | 0.8 | 1.2 | V |
| t _{rr} | Reverse Recovery Time | I _F = 19 A, di/dt = 300 A/μs | – | 29 | 47 | ns |
| Q _{rr} | Reverse Recovery Charge | | – | 33 | 53 | nC |

Product parametric performance is indicated in the Electrical Characteristics for the listed test conditions, unless otherwise noted. Product performance may not be indicated by the Electrical Characteristics if operated under different conditions.

4. Pulse Test: Pulse Width < 300 μs, Duty Cycle < 2.0%

TYPICAL CHARACTERISTICS

($T_J = 25^\circ\text{C}$ unless otherwise noted)

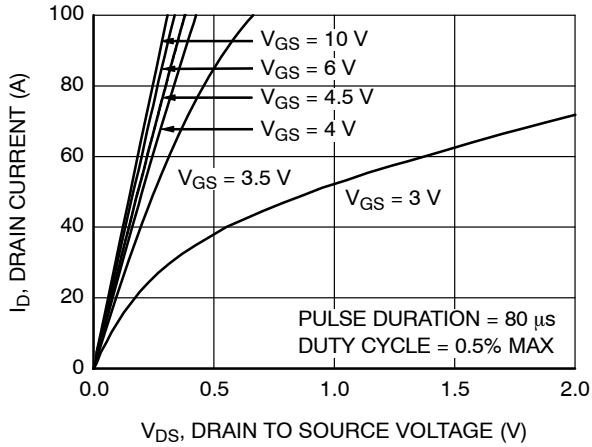

Figure 1. On Region Characteristics

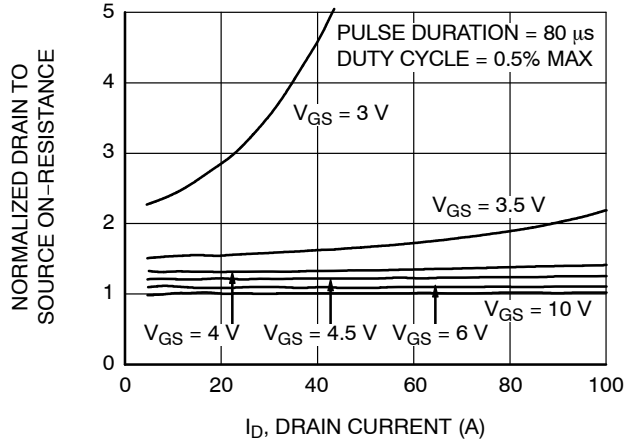

Figure 2. Normalized On-Resistance vs. Drain Current and Gate Voltage

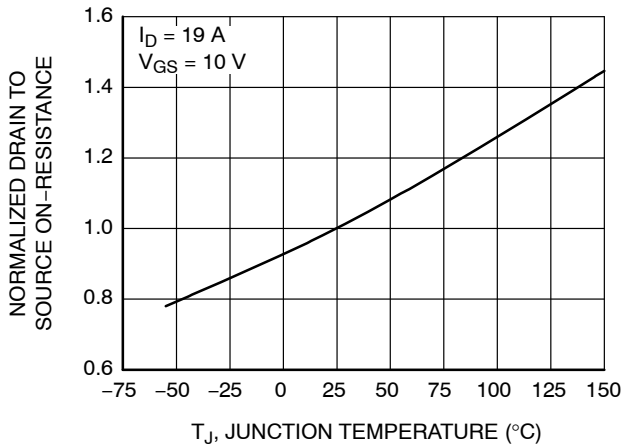

Figure 3. Normalized On-Resistance vs. Junction Temperature

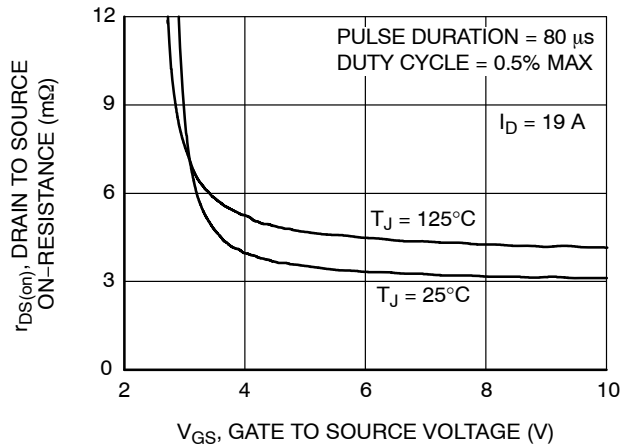

Figure 4. On-Resistance vs. Gate to Source Voltage

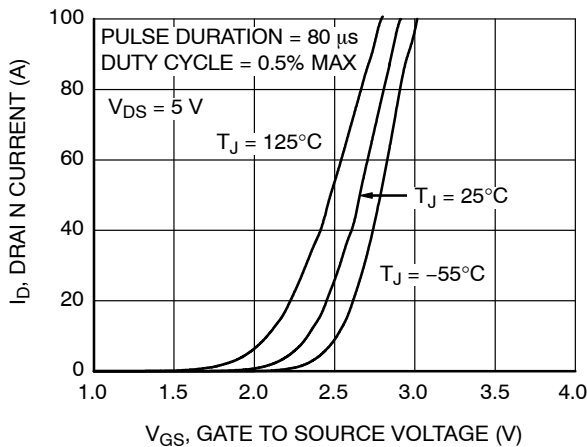

Figure 5. Transfer Characteristics

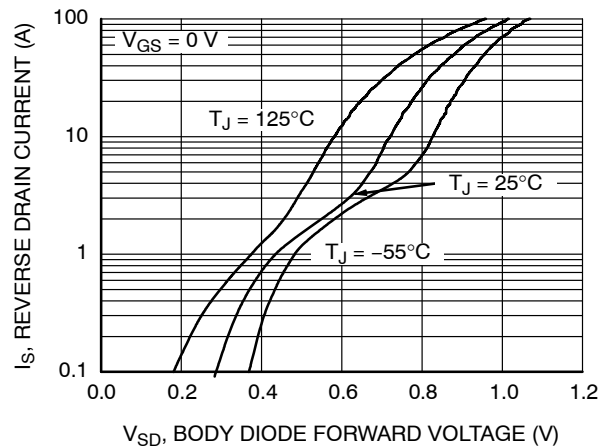

Figure 6. Source to Drain Diode Forward Voltage vs. Source Current

TYPICAL CHARACTERISTICS

($T_J = 25^\circ\text{C}$ unless otherwise noted) (continued)

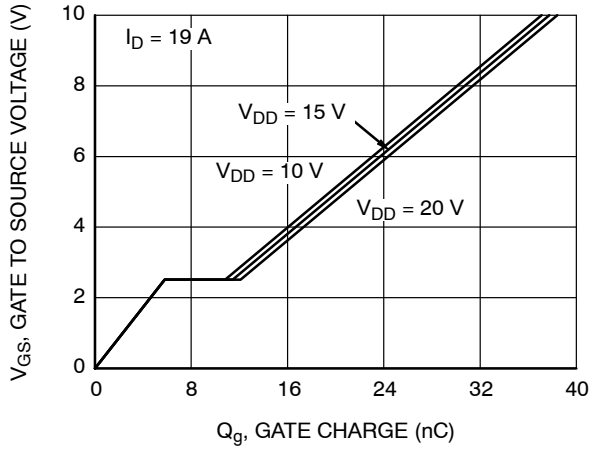

Figure 7. Gate Charge Characteristics

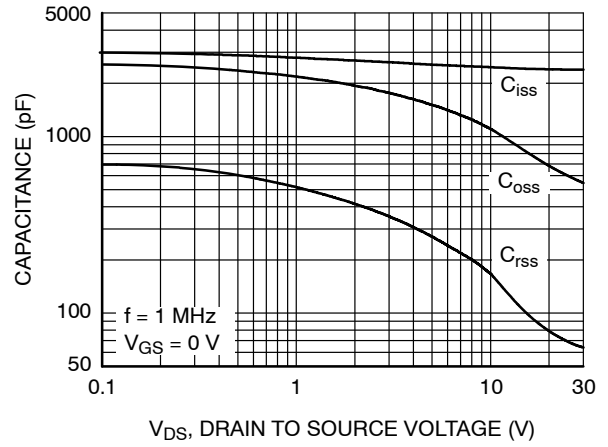

Figure 8. Capacitance vs. Drain to Source Voltage

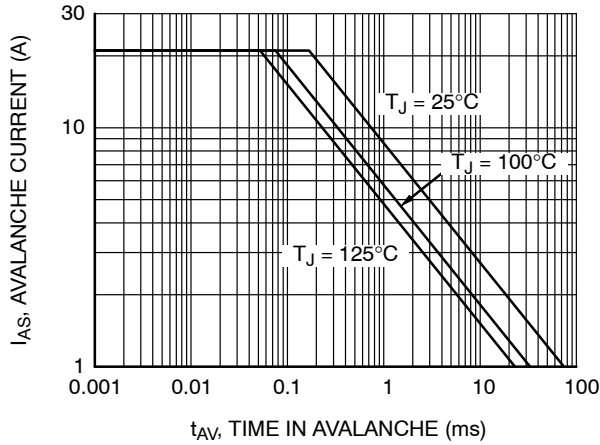

Figure 9. Unclamped Inductive Switching Capability

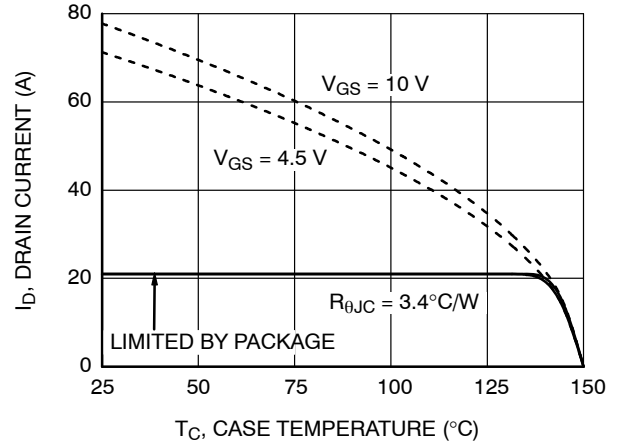

Figure 10. Maximum Continuous Drain Current vs. Case Temperature

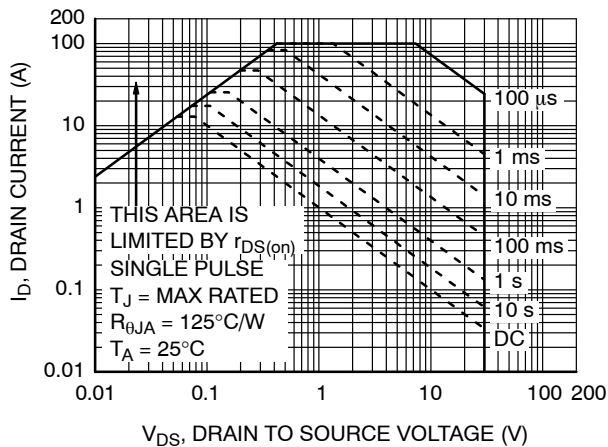

Figure 11. Forward Bias Safe Operating Area

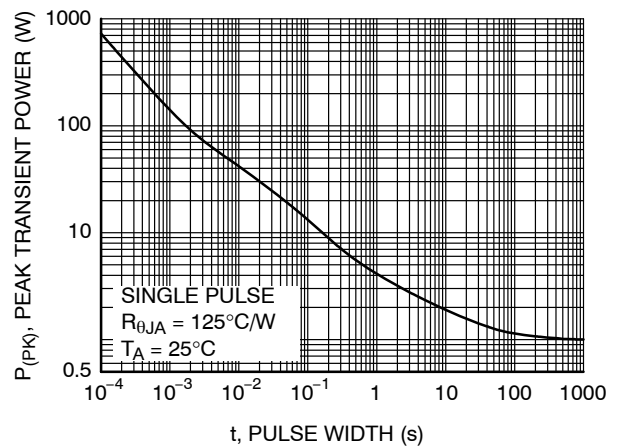

Figure 12. Single Pulse Maximum Power Dissipation

TYPICAL CHARACTERISTICS

($T_J = 25^\circ\text{C}$ unless otherwise noted) (continued)

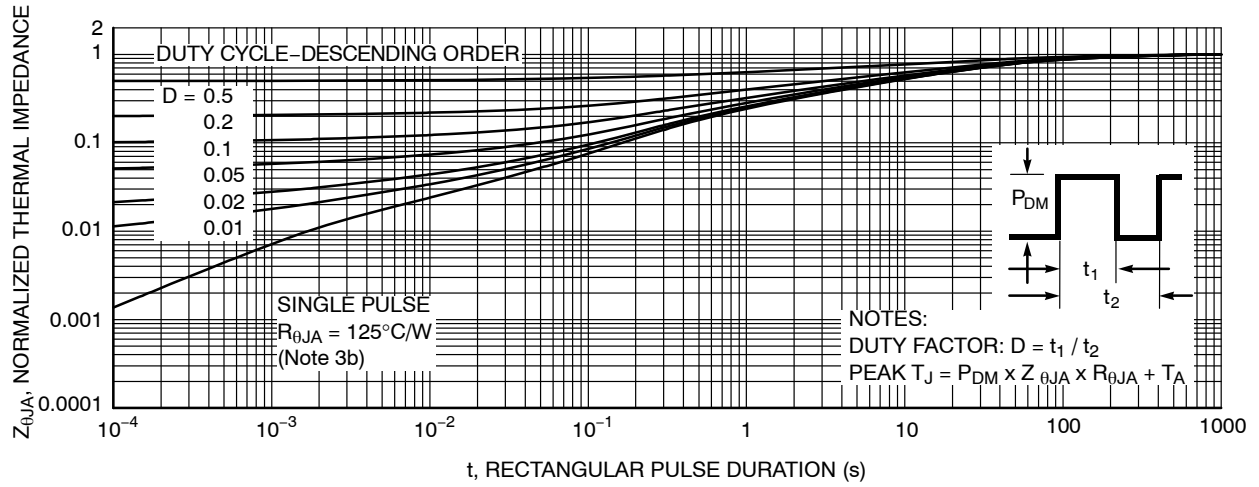

Figure 13. Junction-to-Ambient Transient Thermal Response Curve

FDMC0310AS, FDMC0310AS-F127

TYPICAL CHARACTERISTICS (continued)

SyncFET Schottky Body Diode Characteristics

onsemi SyncFET process embeds a Schottky diode in parallel with POWERTRENCH MOSFET. This diode exhibits similar characteristics to a discrete external Schottky diode in parallel with a MOSFET. Figure 14 shows the reverse recovery characteristic of the FDMC0310AS.

Schottky barrier diodes exhibit significant leakage at high temperature and high reverse voltage. This will increase the power in the device.

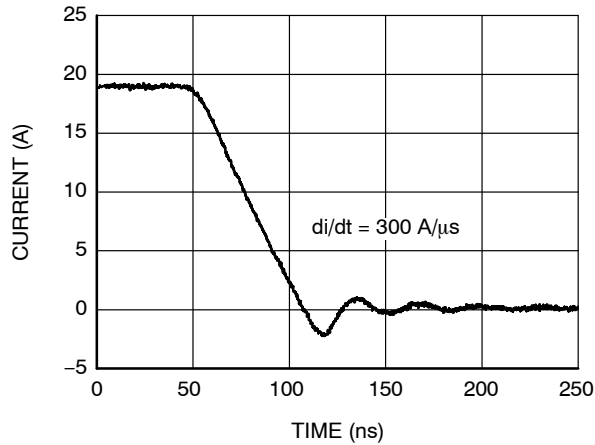

Figure 14. SyncFET Body Diode Reverse Recovery Characteristics

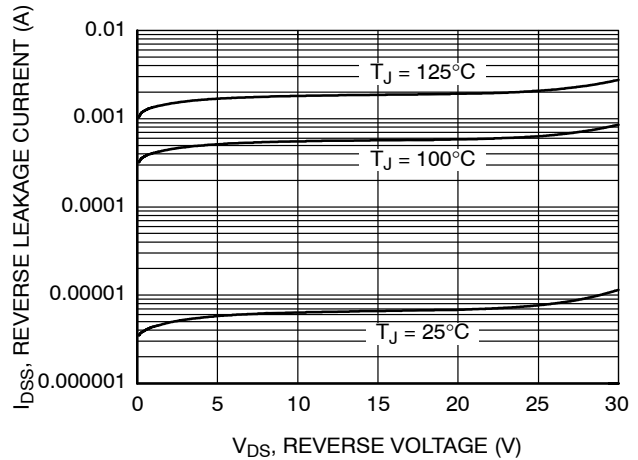

Figure 15. SyncFET Body Diode Reverse Leakage vs. Drain-Source Voltage

PACKAGE MARKING AND ORDERING INFORMATION

| Device | Device Marking | Package Type | Reel Size | Tape Width | Shipping [†] |
|-----------------|----------------|--|-----------|------------|-----------------------|
| FDMC0310AS | FDMC0310AS | WDFN8 3.3x3.3, 0.65P MLP (SAWN) (Pb-Free) | 13" | 12 mm | 3000 / Tape & Reel |
| FDMC0310AS-F127 | FDMC0310AS | WDFN8 3.3x3.3, 0.65P MLP (PUNCH) (Pb-Free) | 13" | 12 mm | 3000 / Tape & Reel |

[†]For information on tape and reel specifications, including part orientation and tape sizes, please refer to our Tape and Reel Packaging Specifications Brochure, BRD8011/D.

POWERTRENCH is registered trademark of Semiconductor Components Industries, LLC dba "onsemi" or its affiliates and/or subsidiaries in the United States and/or other countries.

SyncFET is trademark of Semiconductor Components Industries, LLC dba "onsemi" or its affiliates and/or subsidiaries in the United States and/or other countries.

MECHANICAL CASE OUTLINE

PACKAGE DIMENSIONS

ON Semiconductor®



WDFN8 3.3x3.3, 0.65P
CASE 511DH
ISSUE O

DATE 31 JUL 2016

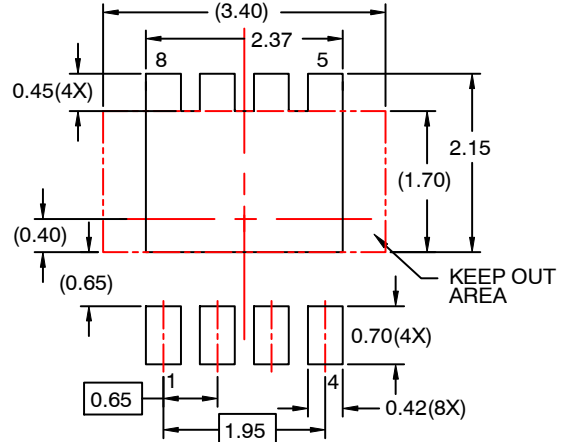
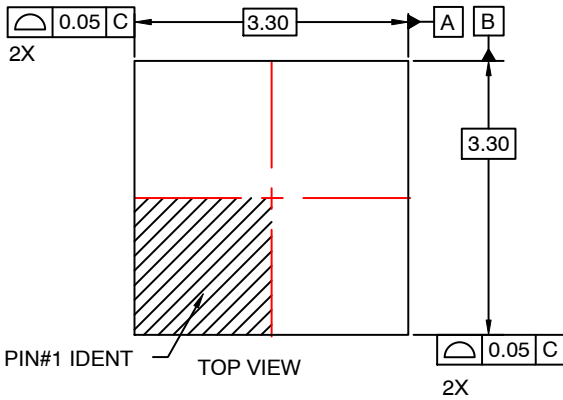

RECOMMENDED LAND PATTERN

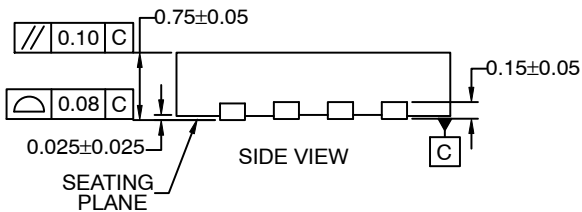

NOTES:

- A. DOES NOT CONFORM TO JEDEC REGISTRATION MO-229
- B. DIMENSIONS ARE IN MILLIMETERS.
- C. DIMENSIONS AND TOLERANCES PER ASME Y14.5M, 2009.
- D. LAND PATTERN RECOMMENDATION IS EXISTING INDUSTRY LAND PATTERN.

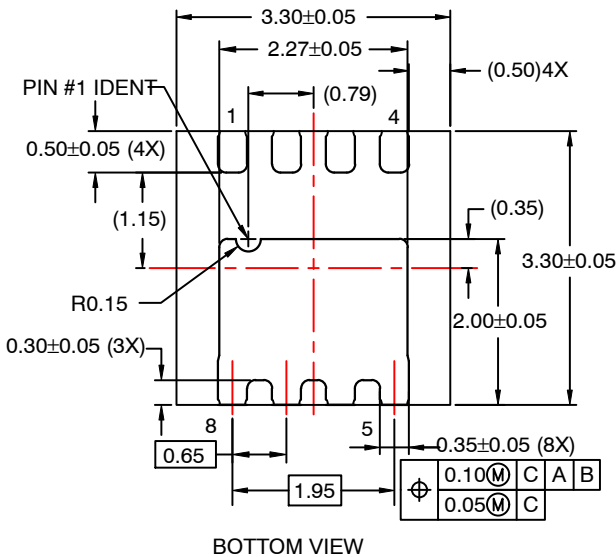

BOTTOM VIEW

| | | |
|-------------------------|-----------------------------|--|
| DOCUMENT NUMBER: | 98AON13625G | Electronic versions are uncontrolled except when accessed directly from the Document Repository. Printed versions are uncontrolled except when stamped "CONTROLLED COPY" in red. |
| DESCRIPTION: | WDFN8 3.3X3.3, 0.65P | PAGE 1 OF 1 |

ON Semiconductor and are trademarks of Semiconductor Components Industries, LLC dba ON Semiconductor or its subsidiaries in the United States and/or other countries. ON Semiconductor reserves the right to make changes without further notice to any products herein. ON Semiconductor makes no warranty, representation or guarantee regarding the suitability of its products for any particular purpose, nor does ON Semiconductor assume any liability arising out of the application or use of any product or circuit, and specifically disclaims any and all liability, including without limitation special, consequential or incidental damages. ON Semiconductor does not convey any license under its patent rights nor the rights of others.

MECHANICAL CASE OUTLINE

PACKAGE DIMENSIONS

ON Semiconductor®



WDFN8 3.3x3.3, 0.65P

CASE 511DQ

ISSUE O

DATE 31 OCT 2016

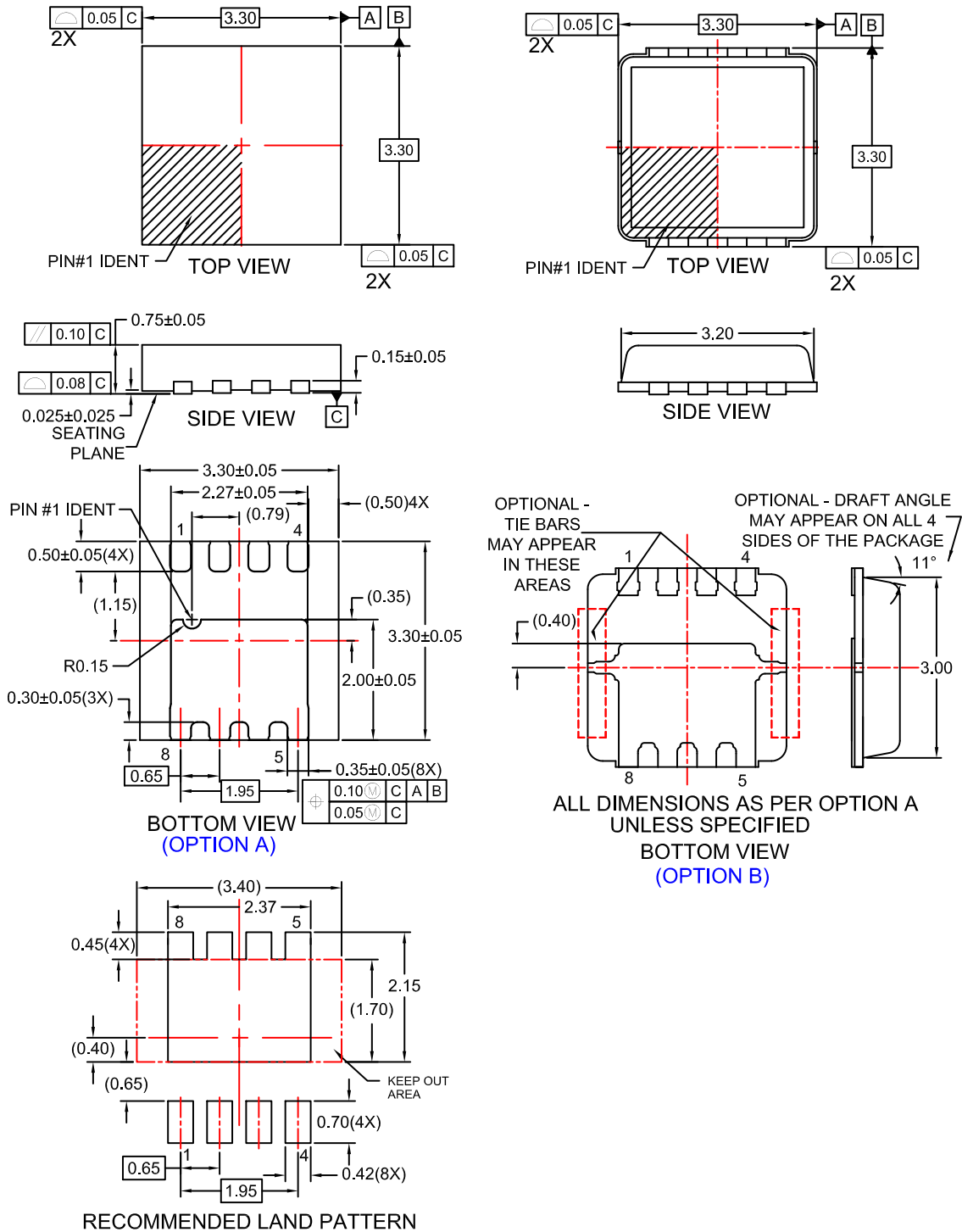

| | | |
|-------------------------|-----------------------------|--|
| DOCUMENT NUMBER: | 98AON13648G | Electronic versions are uncontrolled except when accessed directly from the Document Repository. Printed versions are uncontrolled except when stamped "CONTROLLED COPY" in red. |
| DESCRIPTION: | WDFN8 3.3X3.3, 0.65P | PAGE 1 OF 2 |

ON Semiconductor and are trademarks of Semiconductor Components Industries, LLC dba ON Semiconductor or its subsidiaries in the United States and/or other countries. ON Semiconductor reserves the right to make changes without further notice to any products herein. ON Semiconductor makes no warranty, representation or guarantee regarding the suitability of its products for any particular purpose, nor does ON Semiconductor assume any liability arising out of the application or use of any product or circuit, and specifically disclaims any and all liability, including without limitation special, consequential or incidental damages. ON Semiconductor does not convey any license under its patent rights nor the rights of others.

WDFN8 3.3x3.3, 0.65P
CASE 511DQ
ISSUE O

DATE 31 OCT 2016

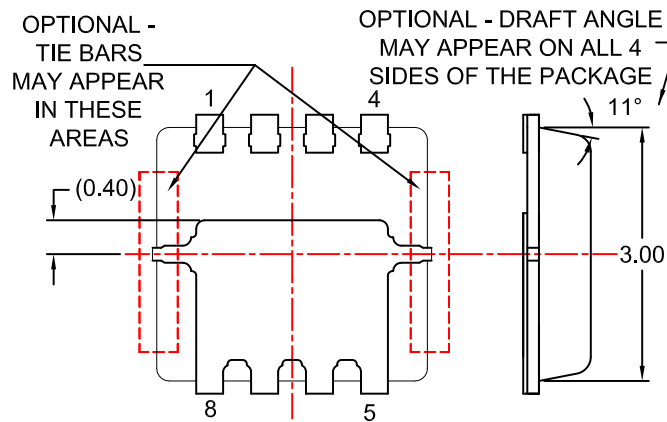
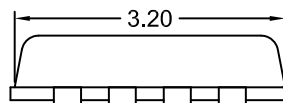
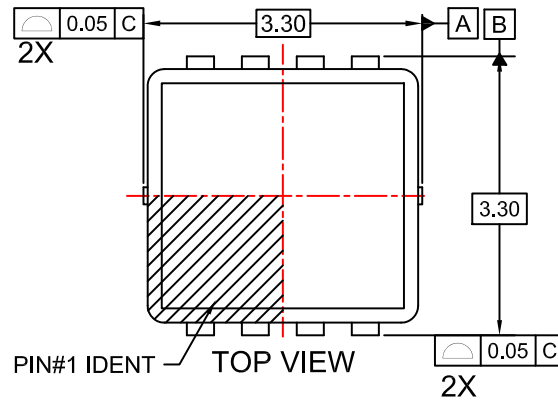

ALL DIMENSIONS AS PER OPTION A
UNLESS SPECIFIED
BOTTOM VIEW
(OPTION C)

NOTES:

- A. PACKAGE DOES NOT FULLY CONFORM TO JEDEC REGISTRATION MO-240.
- B. DIMENSIONS ARE IN MILLIMETERS.
- C. DIMENSIONS AND TOLERANCES PER ASME Y14.5M, 2009.
- D. LAND PATTERN RECOMMENDATION IS EXISTING INDUSTRY LAND PATTERN
- E. DIMENSIONS DO NOT INCLUDE BURRS OR MOLD FLASH. BURRS OR MOLD FLASH SHALL NOT EXCEED 0.10MM.

| | | |
|-------------------------|-----------------------------|---|
| DOCUMENT NUMBER: | 98AON13648G | Electronic versions are uncontrolled except when accessed directly from the Document Repository. Printed versions are uncontrolled except when stamped "CONTROLLED COPY" in red. |
| DESCRIPTION: | WDFN8 3.3X3.3, 0.65P | PAGE 2 OF 2 |

ON Semiconductor and are trademarks of Semiconductor Components Industries, LLC dba ON Semiconductor or its subsidiaries in the United States and/or other countries. ON Semiconductor reserves the right to make changes without further notice to any products herein. ON Semiconductor makes no warranty, representation or guarantee regarding the suitability of its products for any particular purpose, nor does ON Semiconductor assume any liability arising out of the application or use of any product or circuit, and specifically disclaims any and all liability, including without limitation special, consequential or incidental damages. ON Semiconductor does not convey any license under its patent rights nor the rights of others.

onsemi, **Onsemi**, and other names, marks, and brands are registered and/or common law trademarks of Semiconductor Components Industries, LLC dba "**onsemi**" or its affiliates and/or subsidiaries in the United States and/or other countries. **onsemi** owns the rights to a number of patents, trademarks, copyrights, trade secrets, and other intellectual property. A listing of **onsemi**'s product/patent coverage may be accessed at www.onsemi.com/site/pdf/Patent-Marking.pdf. **onsemi** reserves the right to make changes at any time to any products or information herein, without notice. The information herein is provided "as-is" and **onsemi** makes no warranty, representation or guarantee regarding the accuracy of the information, product features, availability, functionality, or suitability of its products for any particular purpose, nor does **onsemi** assume any liability arising out of the application or use of any product or circuit, and specifically disclaims any and all liability, including without limitation special, consequential or incidental damages. Buyer is responsible for its products and applications using **onsemi** products, including compliance with all laws, regulations and safety requirements or standards, regardless of any support or applications information provided by **onsemi**. "Typical" parameters which may be provided in **onsemi** data sheets and/or specifications can and do vary in different applications and actual performance may vary over time. All operating parameters, including "Typicals" must be validated for each customer application by customer's technical experts. **onsemi** does not convey any license under any of its intellectual property rights nor the rights of others. **onsemi** products are not designed, intended, or authorized for use as a critical component in life support systems or any FDA Class 3 medical devices or medical devices with a same or similar classification in a foreign jurisdiction or any devices intended for implantation in the human body. Should Buyer purchase or use **onsemi** products for any such unintended or unauthorized application, Buyer shall indemnify and hold **onsemi** and its officers, employees, subsidiaries, affiliates, and distributors harmless against all claims, costs, damages, and expenses, and reasonable attorney fees arising out of, directly or indirectly, any claim of personal injury or death associated with such unintended or unauthorized use, even if such claim alleges that **onsemi** was negligent regarding the design or manufacture of the part. **onsemi** is an Equal Opportunity/Affirmative Action Employer. This literature is subject to all applicable copyright laws and is not for resale in any manner.

ADDITIONAL INFORMATION

TECHNICAL PUBLICATIONS:

Technical Library: www.onsemi.com/design/resources/technical-documentation
onsemi Website: www.onsemi.com

ONLINE SUPPORT: www.onsemi.com/support

For additional information, please contact your local Sales Representative at www.onsemi.com/support/sales