

## Turbo 2 ultrafast high voltage rectifier

Datasheet - production data

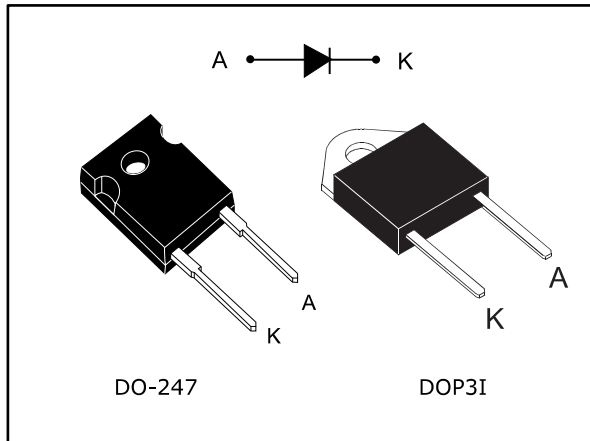

### Description

The device is developed using ST's Turbo 2 600 V technology. It is well-suited as a boost diode, especially for use in continuous mode power factor corrections and hard switching conditions.

This device is also intended for use as a free wheeling diode in power supplies and other power switching applications.

**Table 1: Device summary**

Symbol	Value
$I_{F(AV)}$	30 A
$V_{RRM}$	600 V
$V_F$ (typ.)	1.10 V
$T_j$	175 °C
$t_{rr}$ (max)	50 ns

### Features

- Ultrafast switching
- Low reverse current
- Low thermal resistance
- Reduces switching and conduction losses
- Insulated package: DOP3I
  - Insulating voltage = 2500 V<sub>RMS</sub> sine

# 1 Characteristics

**Table 2: Absolute ratings (limiting values at 25 °C, unless otherwise specified)**

Symbol	Parameter		Value	Unit
V <sub>RRM</sub>	Repetitive peak reverse voltage		600	V
I <sub>F(RMS)</sub>	Forward rms current		50	A
I <sub>F(AV)</sub>	Average forward current, δ = 0.5 square wave	DO-247 T <sub>C</sub> = 115 °C	30	A
		DOP3I T <sub>C</sub> = 85 °C		
I <sub>FSM</sub>	Surge non repetitive forward current	t <sub>p</sub> = 10 ms sinusoidal	300	A
T <sub>stg</sub>	Storage temperature range		-65 to +175	°C
T <sub>j</sub>	Maximum operating junction temperature		175	°C

**Table 3: Thermal parameters**

Symbol	Parameter		Max. value	Unit
R <sub>th(j-c)</sub>	Junction to case	DO-247	1.1	°C/W
		DOP3I	1.7	

**Table 4: Static electrical characteristics**

Symbol	Parameter	Test conditions		Min.	Typ.	Max.	Unit
I <sub>R</sub> <sup>(1)</sup>	Reverse leakage current	T <sub>j</sub> = 25 °C	V <sub>R</sub> = V <sub>RRM</sub>	-		25	μA
		T <sub>j</sub> = 150 °C		-	80	800	
V <sub>F</sub> <sup>(2)</sup>	Forward voltage drop	T <sub>j</sub> = 25 °C	I <sub>F</sub> = 30 A	-		1.85	V
		T <sub>j</sub> = 150 °C		-	1.10	1.40	

**Notes:**

(1)Pulse test: t<sub>p</sub> = 5 ms, δ < 2%

(2)Pulse test: t<sub>p</sub> = 380 μs, δ < 2%

To evaluate the conduction losses, use the following equation:

$$P = 1.07 \times I_{F(AV)} + 0.011 \times I_{F(RMS)}^2$$

Table 5: Dynamic electrical characteristics

Symbol	Parameter	Test conditions		Min.	Typ.	Max.	Unit
$t_{rr}$	Reverse recovery time	$T_j = 25\text{ °C}$	$I_F = 0.5\text{ A}$ $I_{rr} = 0.25\text{ A}$ $I_R = 1\text{ A}$	-		50	ns
			$I_F = 1\text{ A}$ $V_R = 30\text{ V}$ $di_F/dt = -50\text{ A}/\mu\text{s}$	-	50	70	
$I_{RM}$	Reverse recovery current	$T_j = 125\text{ °C}$	$I_F = 30\text{ A}$ $V_R = 400\text{ V}$ $di_F/dt = -100\text{ A}/\mu\text{s}$	-	8	11	A
$t_{fr}$	Forward recovery time	$T_j = 25\text{ °C}$	$I_F = 30\text{ A}$ $V_{FR} = 1.1 \times V_F \text{ max}$ $di_F/dt = 100\text{ A}/\mu\text{s}$	-		500	ns
$V_{FP}$	Forward recovery voltage			-	2.5		V

### 1.1 Characteristics (curves)

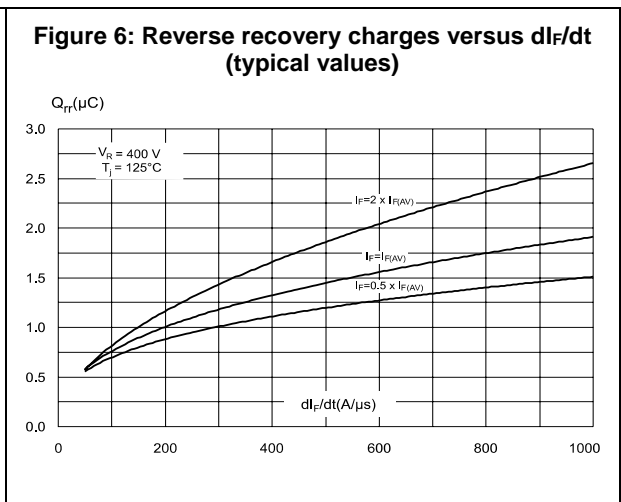
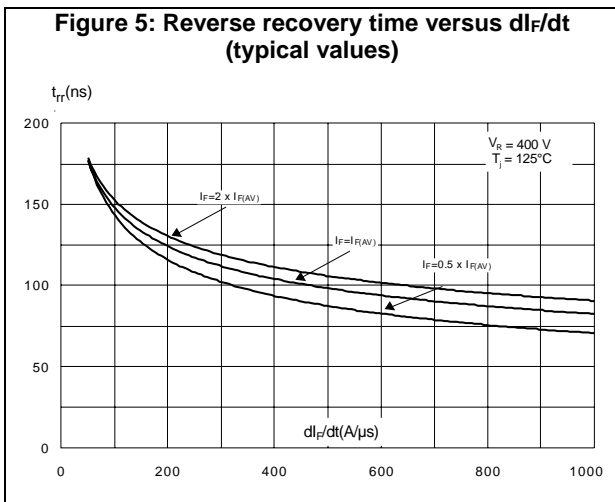
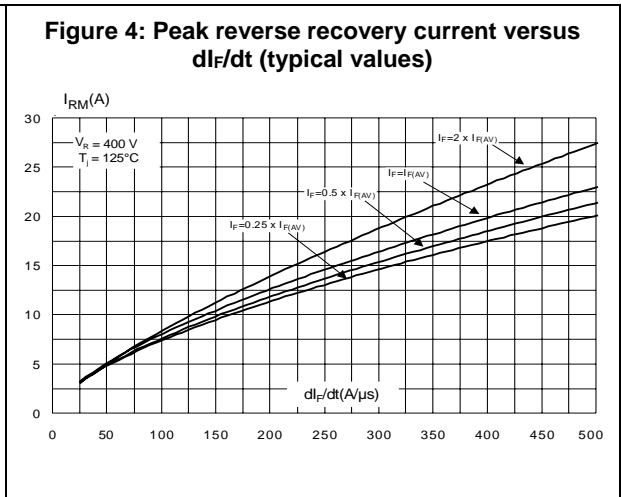
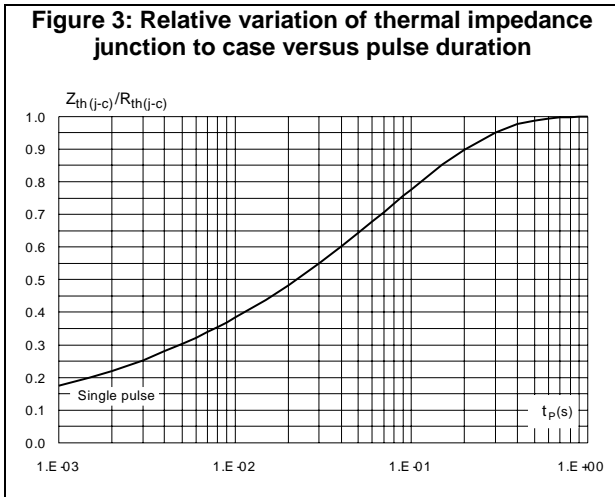
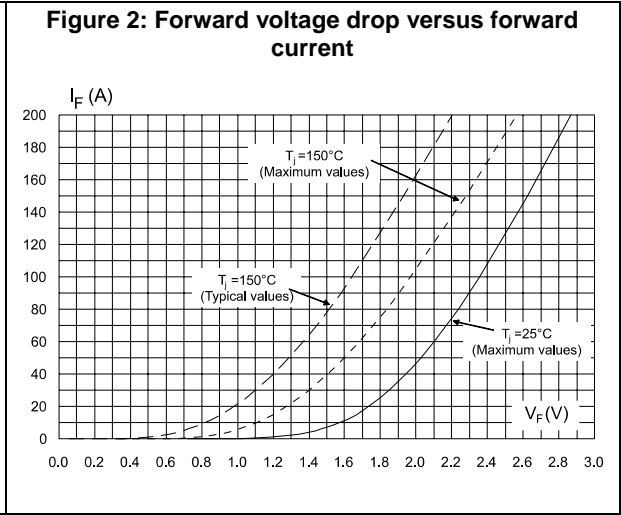
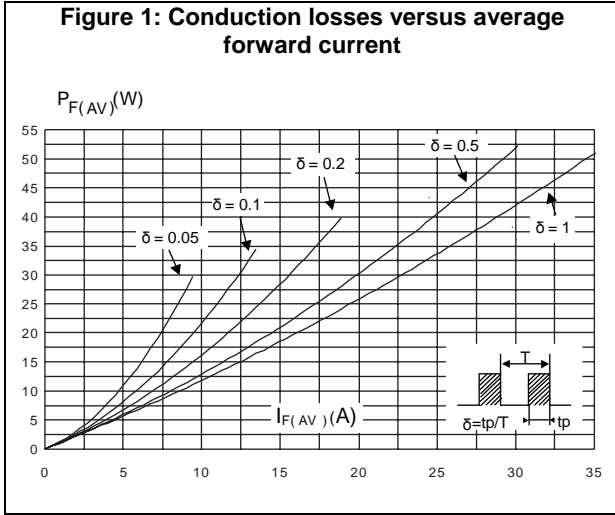

**Figure 7: Softness factor versus  $di_F/dt$  (typical values)**

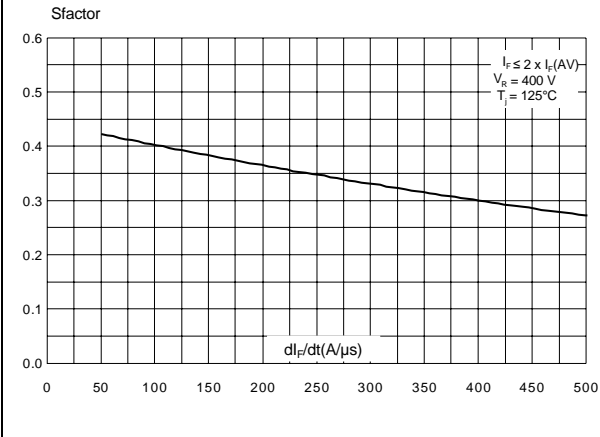

**Figure 8: Relative variations of dynamic parameters versus junction temperature**

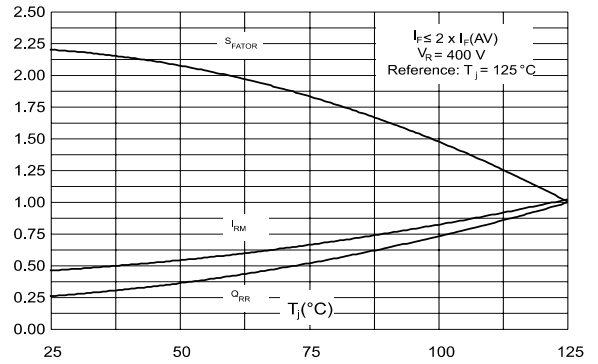

**Figure 9: Transient peak forward voltage versus  $di_F/dt$  (typical values)**

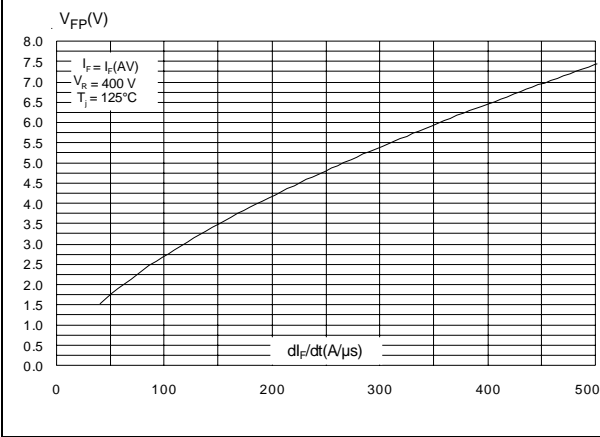

**Figure 10: Forward recovery time versus  $di_F/dt$  (typical values)**

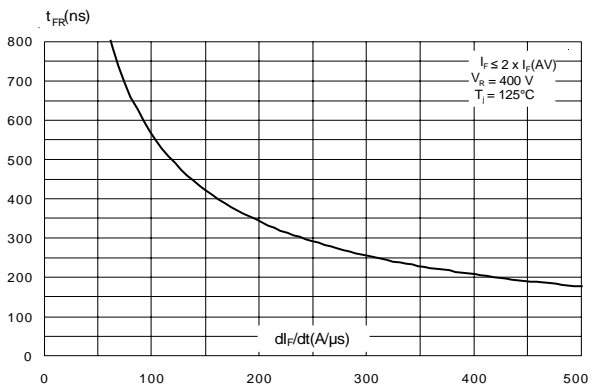
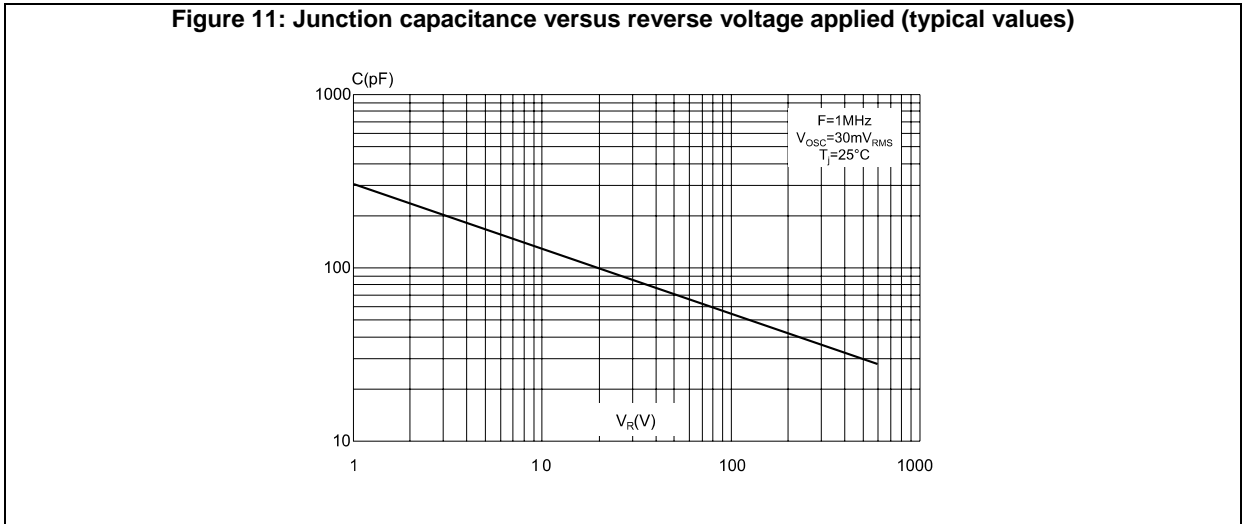

Figure 11: Junction capacitance versus reverse voltage applied (typical values)



## 2 Package information

In order to meet environmental requirements, ST offers these devices in different grades of ECOPACK® packages, depending on their level of environmental compliance. ECOPACK® specifications, grade definitions and product status are available at: [www.st.com](http://www.st.com). ECOPACK® is an ST trademark.

- Epoxy meets UL94, V0
- Cooling method: by conduction (C)
- Recommended torque value: 0.55 N·m (DO-247)
- Recommended torque value: 0.9 to 1.2 N·m (DOP3I)
- Maximum torque value: 1.0 N·m (DO-247)

## 2.1 DO247 package information

Figure 12: DO-247 package outline

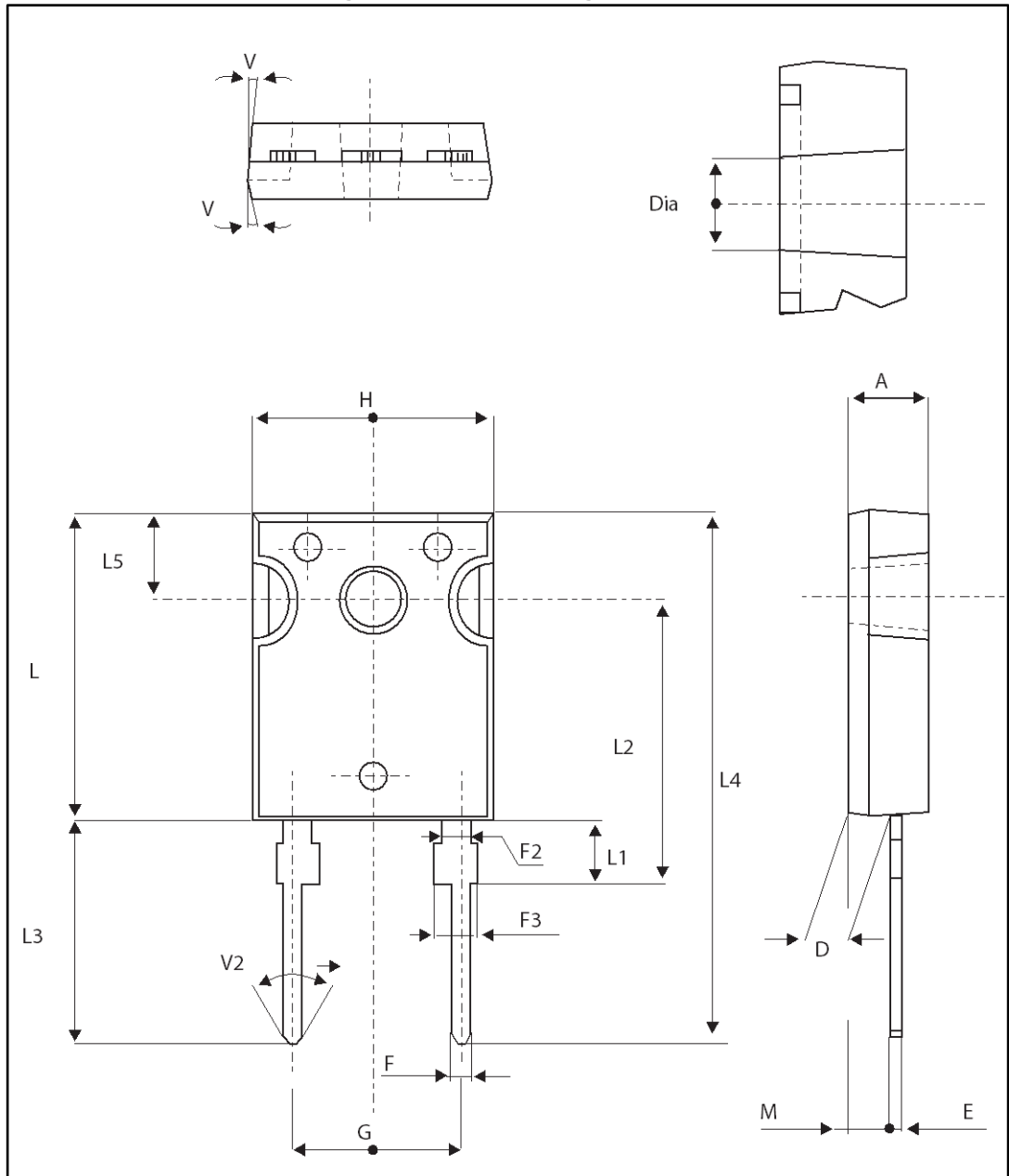



Table 6: DO-247 package mechanical data

Ref.	Dimensions			
	Millimeters		Inches	
	Min.	Max.	Min.	Max.
A	4.85	5.15	0.191	0.203
D	2.20	2.60	0.086	0.102
E	0.40	0.80	0.015	0.031
F	1.00	1.40	0.039	0.055
F2	2.00 typ.		0.078 typ.	
F3	2.00	2.40	0.078	0.094
G	10.90 typ.		0.429 typ.	
H	15.45	15.75	0.608	0.620
L	19.85	20.15	0.781	0.793
L1	3.70	4.30	0.145	0.169
L2	18.50 typ.		0.728 typ.	
L3	14.20	14.80	0.559	0.582
L4	34.60 typ.		1.362 typ.	
L5	5.50 typ.		0.216 typ.	
M	2.00	3.00	0.078	0.118
V	5°		5°	
V2	60°		60°	
Dia.	3.55	3.65	0.139	0.143

## 2.2 DOP3I package information

Figure 13: DOP3I package outline

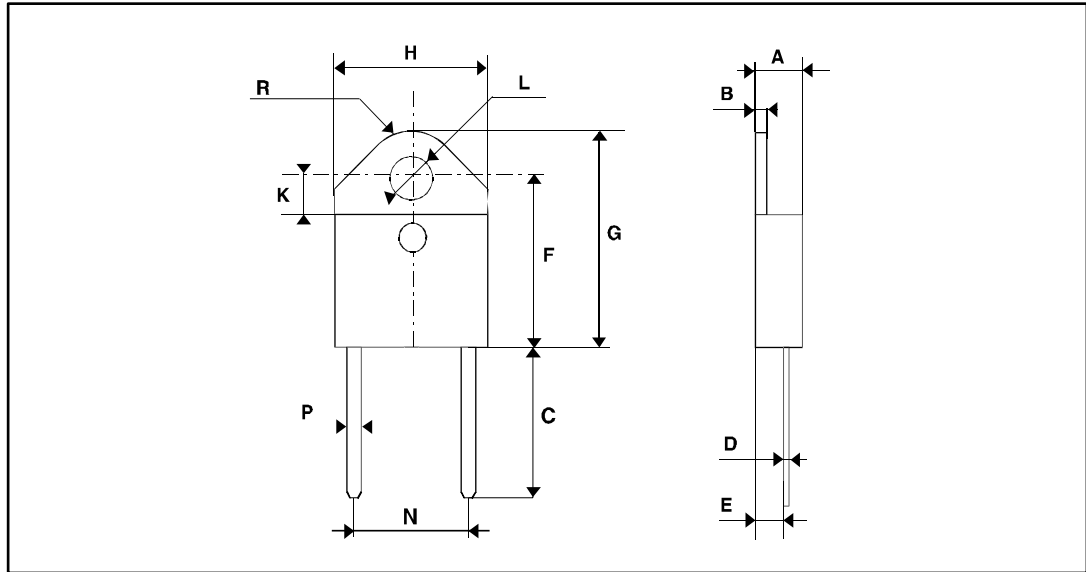

Table 7: DOP3I package mechanical data

Ref.	Dimensions			
	Millimeters		Inches	
	Min.	Max.	Min.	Max.
A	4.40	4.60	0.173	0.181
b	1.20	1.40	0.047	0.055
c	1.45	1.55	0.057	0.061
c1	0.50	0.70	0.020	0.028
D	12.15	13.10	0.474	0.516
E	15.10	15.50	0.594	0.610
E1	7.55	7.75	0.297	0.305
e	10.80	11.30	0.425	0.445
G	20.4	21.10	0.815	0.831
L	14.35	15.60	0.565	0.614
P	4.08	4.17	0.161	0.164
Q	2.70	2.90	0.106	0.114
R	4.60		0.181	
Y	15.80	16.50	0.622	0.650

### 3 Ordering information

Table 8: Ordering information

Order code	Marking	Package	Weight	Base qty.	Delivery mode
STTH3006W	STTH3006W	DO-247	4.40 g	30	Tube
STTH3006PI	STTH3006P	DOP3I	4.46 g	30	Tube

### 4 Revision history

Table 9: Document revision history

Date	Revision	Changes
17-May-2017	1	First issue.

**IMPORTANT NOTICE – PLEASE READ CAREFULLY**

STMicroelectronics NV and its subsidiaries ("ST") reserve the right to make changes, corrections, enhancements, modifications, and improvements to ST products and/or to this document at any time without notice. Purchasers should obtain the latest relevant information on ST products before placing orders. ST products are sold pursuant to ST's terms and conditions of sale in place at the time of order acknowledgement.

Purchasers are solely responsible for the choice, selection, and use of ST products and ST assumes no liability for application assistance or the design of Purchasers' products.

No license, express or implied, to any intellectual property right is granted by ST herein.

Resale of ST products with provisions different from the information set forth herein shall void any warranty granted by ST for such product.

ST and the ST logo are trademarks of ST. All other product or service names are the property of their respective owners.

Information in this document supersedes and replaces information previously supplied in any prior versions of this document.

© 2017 STMicroelectronics – All rights reserved