

# 2.5A, 18V, 500kHz ACOT™ Synchronous Step-Down Converter

## General Description

The RT7294C is a synchronous step-down converter with Advanced Constant On-Time (ACOT™) mode control. The ACOT™ provides a very fast transient response with few external components. The low impedance internal MOSFET supports high efficiency operation with wide input voltage range from 4.3V to 18V. The proprietary circuit of the RT7294C enables to support all ceramic capacitors.

## Ordering Information

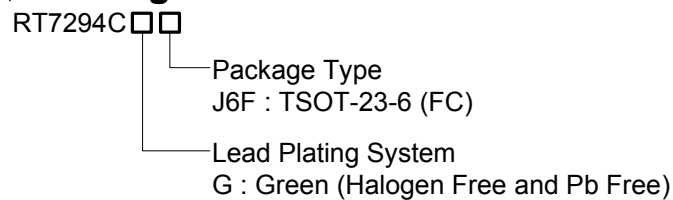

Note :

Richtek products are :

- ▶ RoHS compliant and compatible with the current requirements of IPC/JEDEC J-STD-020.
- ▶ Suitable for use in SnPb or Pb-free soldering processes.

## Pin Configurations

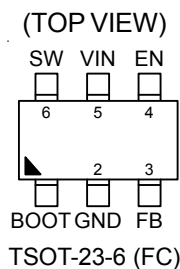

## Features

- 4.3V to 18V Input Voltage Range
- 2.5A Output Current
- Advanced Constant On-Time Control
- Fast Transient Response
- Support All Ceramic Capacitors
- Up to 95% Efficiency
- 500kHz Switching Frequency
- Adjustable Output Voltage from 0.6V to 8V
- Cycle-by-Cycle Current Limit
- Input Under-Voltage Lockout
- Hiccup Mode Under-Voltage Protection
- Thermal Shutdown
- RoHS Compliant and Halogen Free

## Applications

- Industrial and Commercial Low Power Systems
- Computer Peripherals
- LCD Monitors and TVs
- Green Electronics/Appliances
- Point of Load Regulation for High-Performance DSPs, FPGAs, and ASICs

## Marking Information

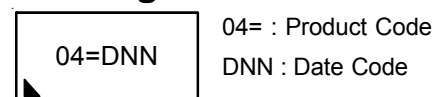

## Simplified Application Circuit

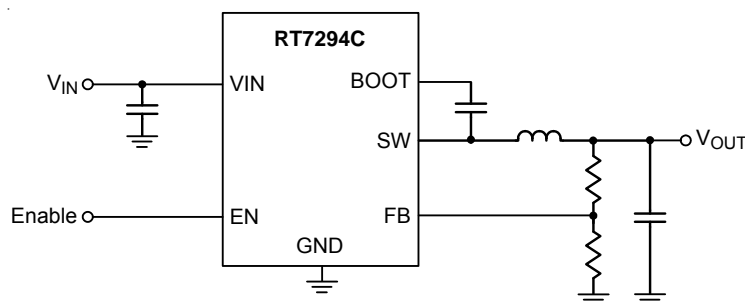

Functional Pin Description

Pin No.	Pin Name	Pin Function
1	BOOT	Bootstrap Supply for High-Side Gate Driver. Connect a 0.1μF ceramic capacitor between the BOOT and SW pins.
2	GND	Power Ground.
3	FB	Feedback Voltage Input. The pin is used to set the output voltage of the converter via a resistive divider. The converter regulates $V_{FB}$ to 0.6V
4	EN	Enable Control Input. Connect EN to a logic-high voltage to enable the IC or to a logic-low voltage to disable. Do not leave this high impedance input unconnected.
5	VIN	Power Input. The input voltage range is from 4.3V to 18V. Must bypass with a suitable large ceramic capacitor at this pin.
6	SW	Switch Node. Connect to external L-C filter.

Function Block Diagram

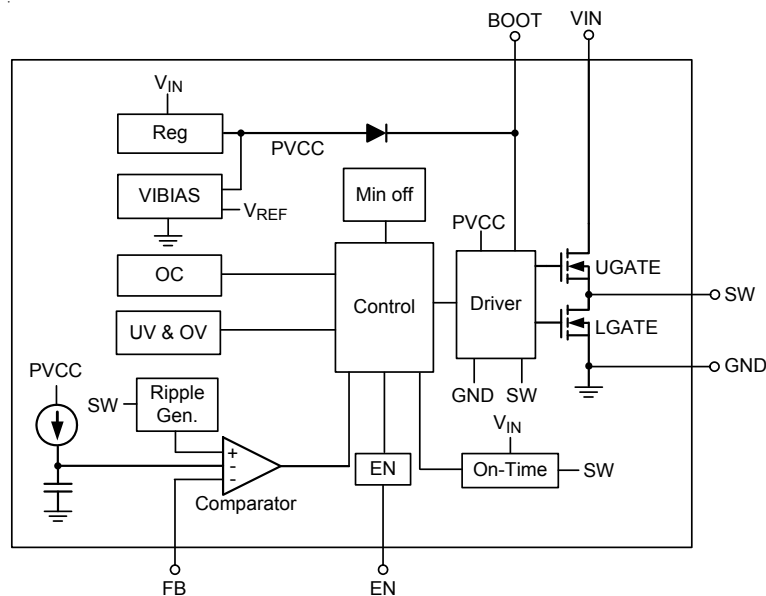

Operation

The RT7294C is a synchronous step-down converter with advanced constant on-time control mode. Using the ACOT control mode can reduce the output capacitance and fast transient response. It can minimize the component size without additional external compensation network.

Current Protection

The inductor current is monitored via the internal switches cycle-by-cycle. Once the output voltage drops under UV threshold, the RT7294C will enter hiccup mode.

UVLO Protection

To protect the chip from operating at insufficient supply voltage, the UVLO is needed. When the input voltage of VIN is lower than the UVLO falling threshold voltage, the device will be lockout.

Thermal Shutdown

When the junction temperature exceeds the OTP threshold value, the IC will shut down the switching operation. Once the junction temperature cools down and is lower than the OTP lower threshold, the converter will autocratically resume switching.

**Absolute Maximum Ratings** (Note 1)

- VIN to GND ----- -0.3V to 20V
- SW to GND ----- -0.3V to (VIN + 0.3V)
- < 10ns ----- -5V to 25V
- BOOT to GND ----- (VSW - 0.3V) to (VSW + 6V)
- Other Pins ----- -0.3V to 6V
- Power Dissipation, PD @ TA = 25°C
- TSOT-23-6 (FC) ----- 1.429W
- Package Thermal Resistance (Note 2)
- TSOT-23-6 (FC), θJA ----- 70°C/W
- TSOT-23-6 (FC), θJC ----- 15°C/W
- Lead Temperature (Soldering, 10 sec.) ----- 260°C
- Junction Temperature ----- 150°C
- Storage Temperature Range ----- -65°C to 150°C
- ESD Susceptibility (Note 3)
- HBM (Human Body Model) ----- 2kV

**Recommended Operating Conditions** (Note 4)

- Supply Input Voltage, VIN ----- 4.3V to 18V
- Junction Temperature Range ----- -40°C to 125°C
- Ambient Temperature Range ----- -40°C to 85°C

**Electrical Characteristics**

(VIN = 12V, TA = 25°C, unless otherwise specified)

Parameter	Symbol	Test Conditions	Min	Typ	Max	Unit	
Shutdown Current	ISHDN	VEN = 0V	--	--	4	μA	
Quiescent Current	IQ	VEN = 2V, VFB = 1V	--	0.5	--	mA	
Switch-On Resistance	High-Side	RDS(ON)_H	VBOOT-SW = 4.8V	--	150	--	mΩ
	Low-Side	RDS(ON)_L	VIN = 5V	--	90	--	
Current Limit	ILIM	Valley Current	2.7	3.4	4	A	
Oscillator Frequency	fSW		--	500	--	kHz	
Maximum Duty Cycle	DMAX		--	90	--	%	
Minimum On-Time	tON		--	60	--	ns	
Feedback Threshold Voltage	VFB	In CCM Mode	591	600	609	mV	
EN Input Threshold	Logic-High	VEN_H	1.19	1.29	1.39	V	
	Logic-Low	VEN_L	0.93	1.03	1.13		
VIN Under-Voltage Lockout Threshold	VUVLO	VIN Rising	3.55	3.9	4.25	V	
VIN Under-Voltage Lockout Threshold Hysteresis			--	340	--	mV	
Soft-Start Time	tSS		--	800	--	μs	
Thermal Shutdown Threshold	TSD		--	160	--	°C	

Parameter	Symbol	Test Conditions	Min	Typ	Max	Unit
Thermal Shutdown Hysteresis	$\Delta T_{SD}$		--	20	--	°C
$V_{OUT}$ Discharge Resistance	$R_{DISCHG}$	EN = 0V, $V_{OUT}$ = 0.5V	--	50	100	$\Omega$
Output Under-Voltage Trip Threshold		UVP detect	70	75	80	%
		Hysteresis	--	10	--	
Output Under-Voltage Delay Time			--	250	--	$\mu s$

**Note 1.** Stresses beyond those listed “Absolute Maximum Ratings” may cause permanent damage to the device. These are stress ratings only, and functional operation of the device at these or any other conditions beyond those indicated in the operational sections of the specifications is not implied. Exposure to absolute maximum rating conditions may affect device reliability.

**Note 2.**  $\theta_{JA}$  is measured at  $T_A = 25^\circ C$  on a high effective thermal conductivity four-layer test board per JEDEC 51-7.  $\theta_{JC}$  is measured at the exposed pad of the package.

**Note 3.** Devices are ESD sensitive. Handling precaution is recommended.

**Note 4.** The device is not guaranteed to function outside its operating conditions.

**Typical Application Circuit**

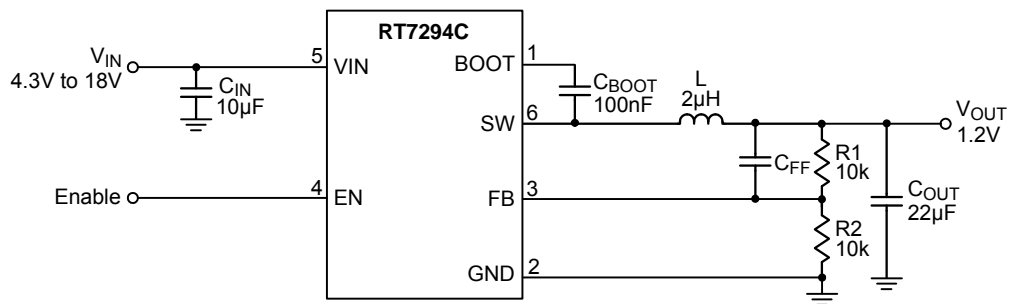

**Table 1. Suggested Component Values**

V <sub>OUT</sub> (V)	R1 (kΩ)	R2 (kΩ)	L (µH)	C <sub>OUT</sub> (µF)	C <sub>FF</sub> (pF)
5	110	15	4.7	22	39
3.3	115	25.5	3.6	22	33
2.5	25.5	8.06	3.6	22	NC
1.2	10	10	2	22	NC

Typical Operating Characteristics

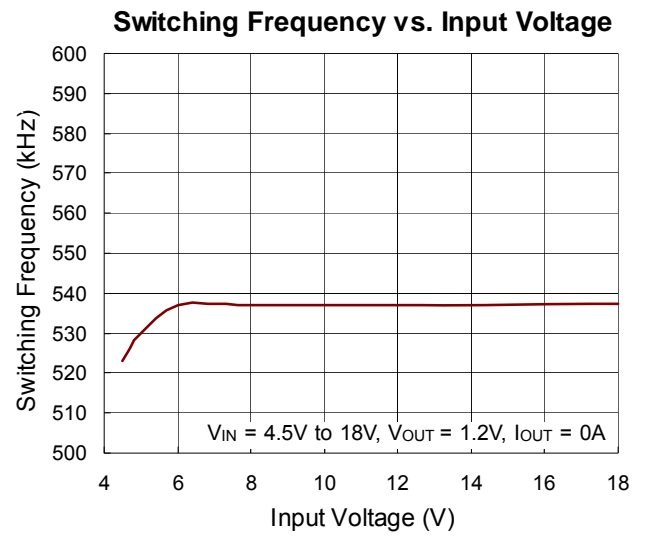
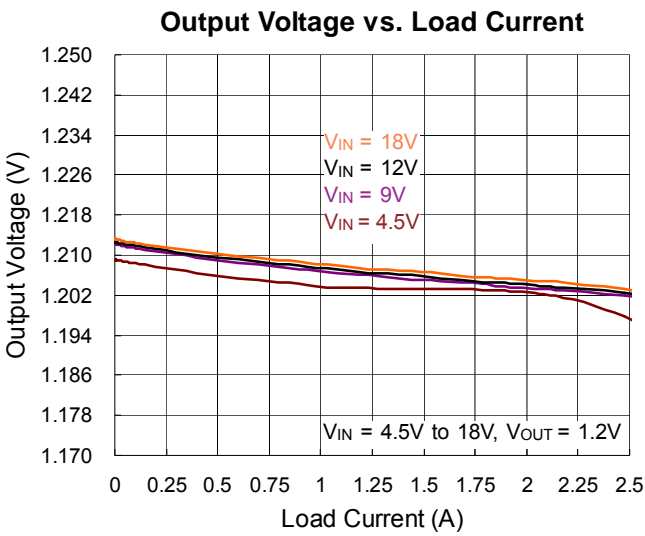
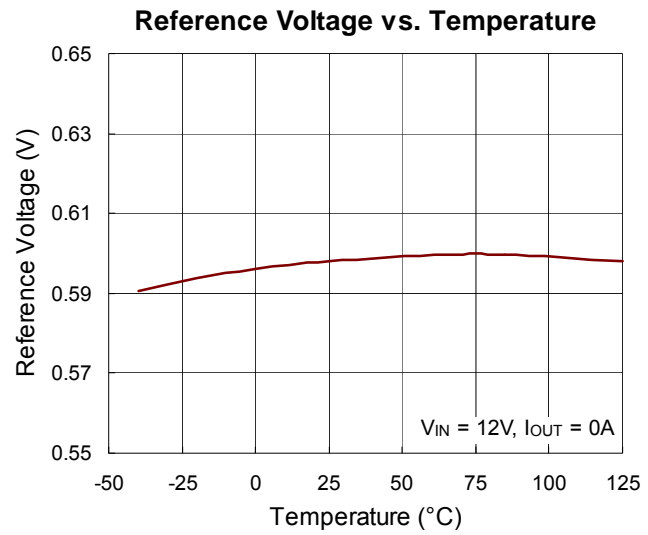
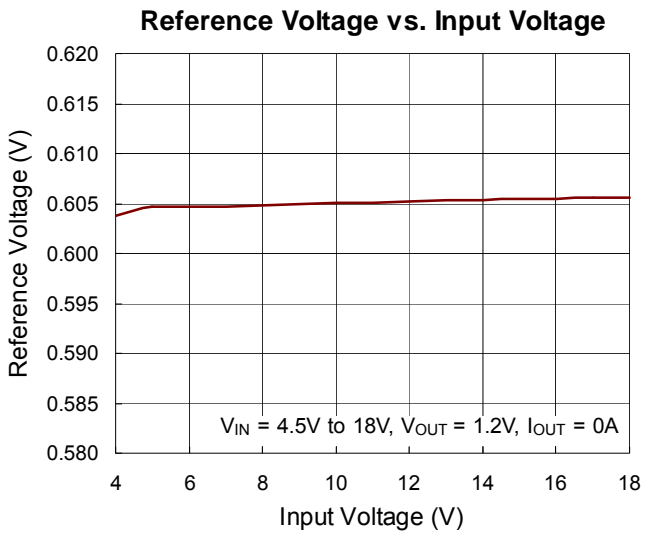
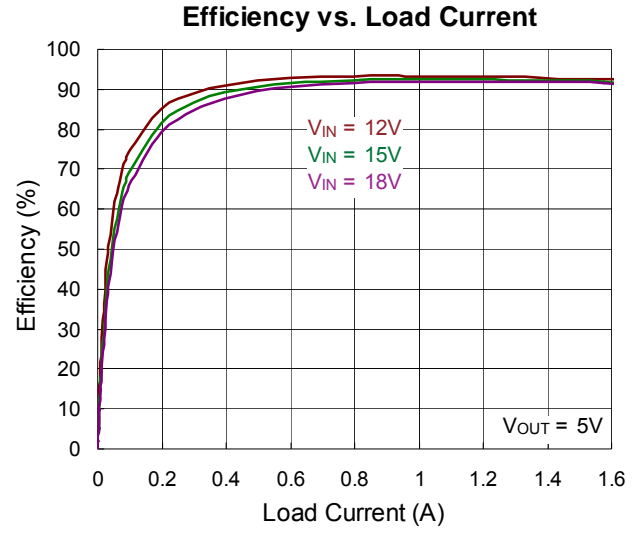
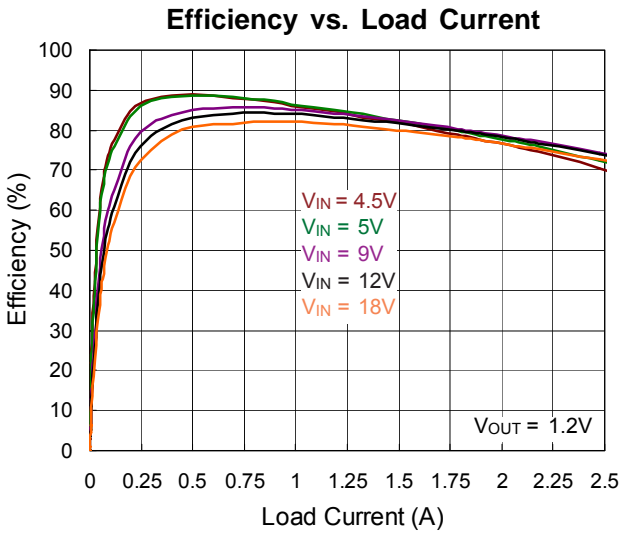

**Switching Frequency vs. Temperature**

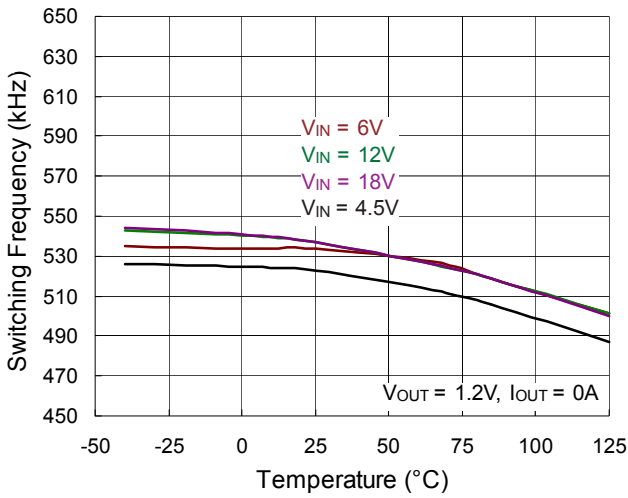

**Current Limit vs. Temperature**

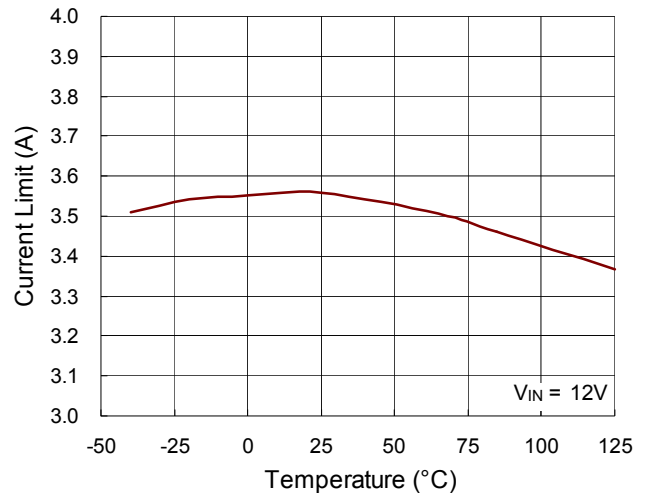

**Load Transient Response**

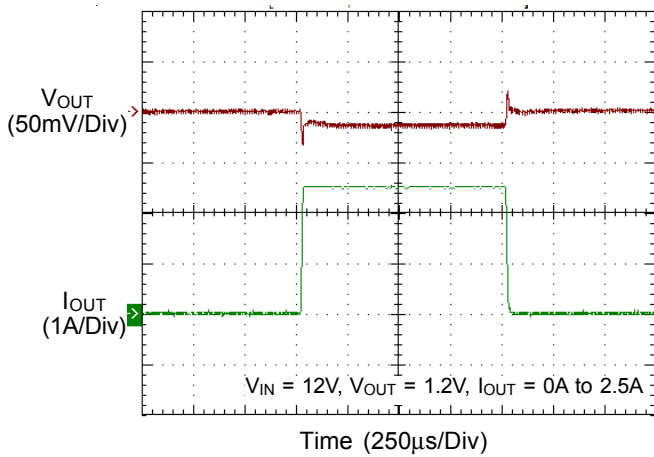

**Load Transient Response**

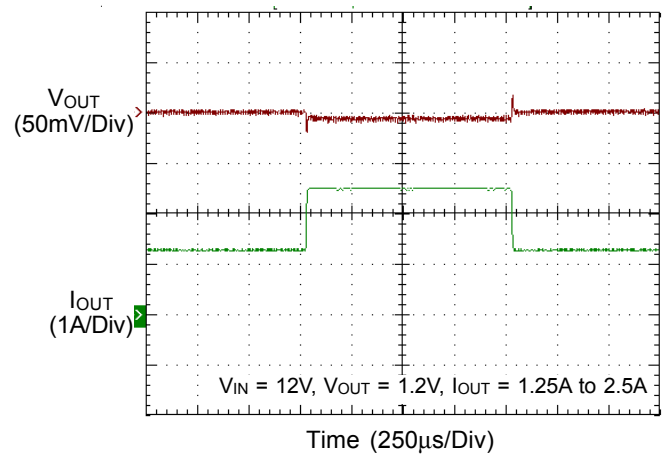

**Switching**

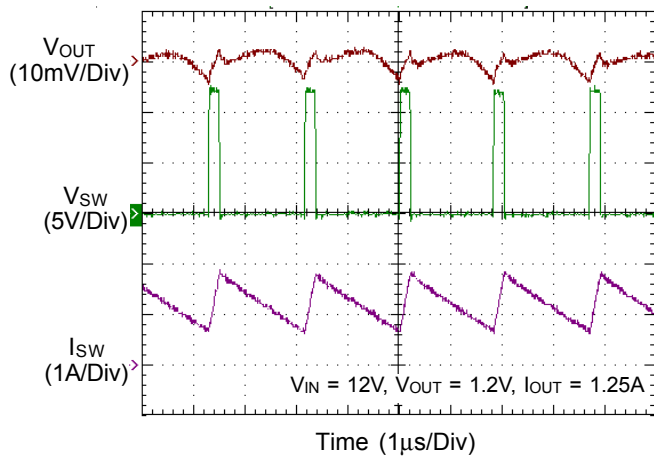

**Switching**

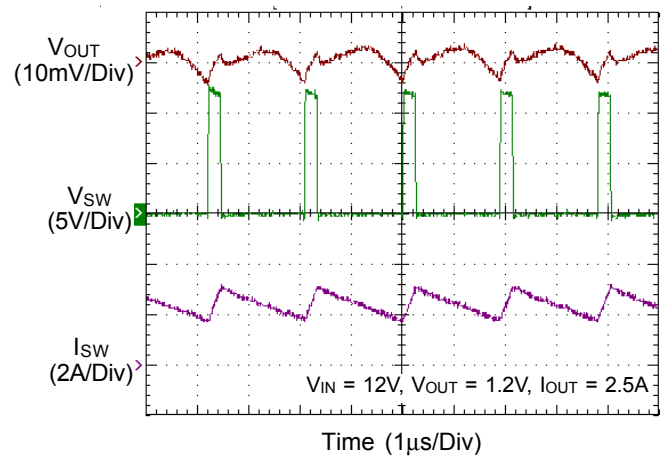

Power On from EN

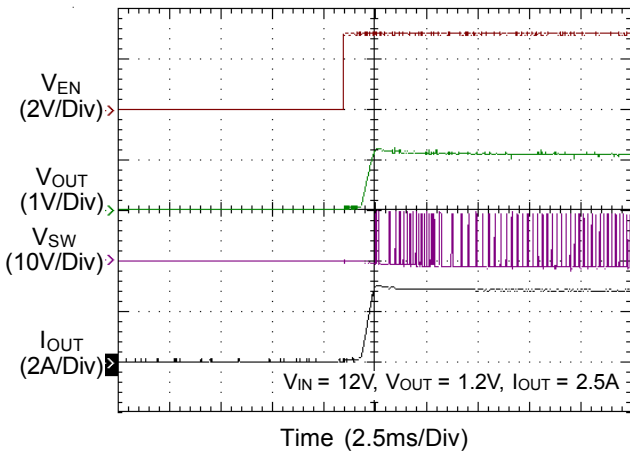

Power Off from EN

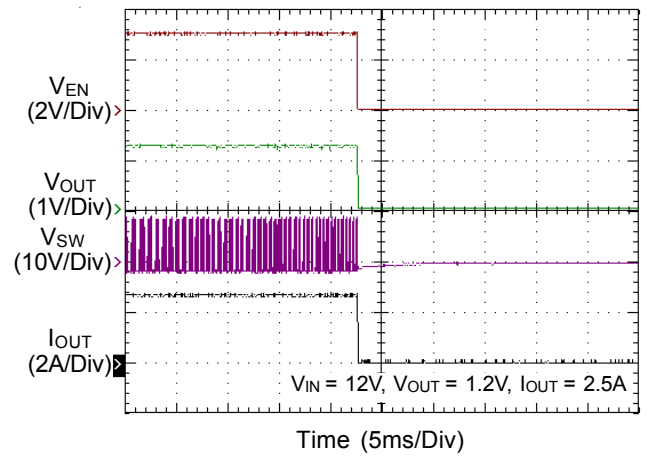

Power On from VIN

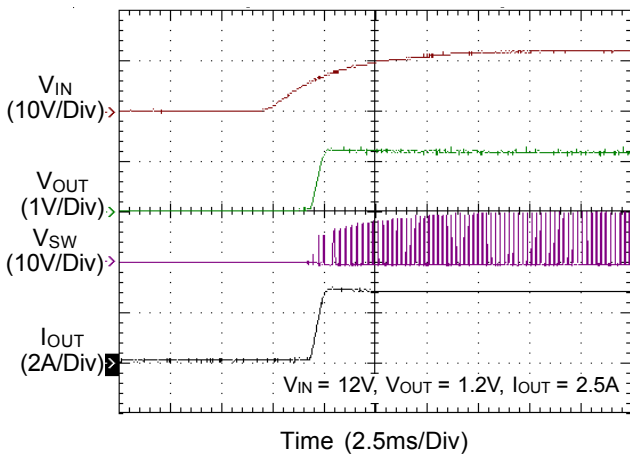

Power Off from VIN

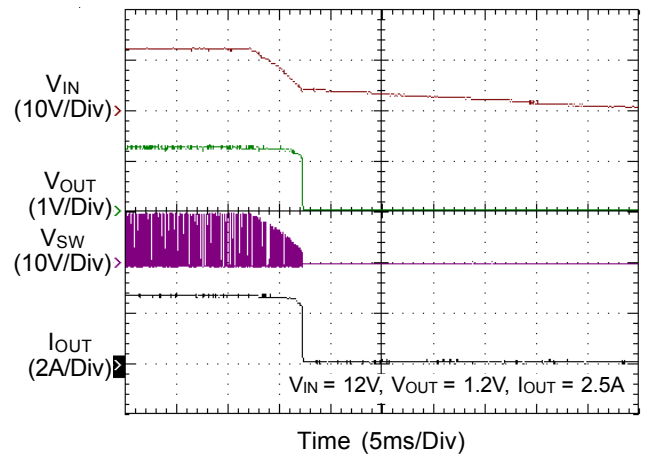



## Application information

### Inductor Selection

Selecting an inductor involves specifying its inductance and also its required peak current. The exact inductor value is generally flexible and is ultimately chosen to obtain the best mix of cost, physical size, and circuit efficiency. Lower inductor values benefit from reduced size and cost and they can improve the circuit's transient response, but they increase the inductor ripple current and output voltage ripple and reduce the efficiency due to the resulting higher peak currents. Conversely, higher inductor values increase efficiency, but the inductor will either be physically larger or have higher resistance since more turns of wire are required and transient response will be slower since more time is required to change current (up or down) in the inductor. A good compromise between size, efficiency, and transient response is to use a ripple current ( $\Delta I_L$ ) about 20% to 40% of the desired full output load current. Calculate the approximate inductor value by selecting the input and output voltages, the switching frequency ( $f_{SW}$ ), the maximum output current ( $I_{OUT(MAX)}$ ) and estimating a  $\Delta I_L$  as some percentage of that current.

$$L = \frac{V_{OUT} \times (V_{IN} - V_{OUT})}{V_{IN} \times f_{SW} \times \Delta I_L}$$

Once an inductor value is chosen, the ripple current ( $\Delta I_L$ ) is calculated to determine the required peak inductor current.

$$\Delta I_L = \frac{V_{OUT} \times (V_{IN} - V_{OUT})}{V_{IN} \times f_{SW} \times L}$$

$$I_{L(PEAK)} = I_{OUT(MAX)} + \frac{\Delta I_L}{2}$$

$$I_{L(VALLY)} = I_{OUT(MAX)} - \frac{\Delta I_L}{2}$$

Considering the Typical Operating Circuit for 1.2V output at 2.5A and an input voltage of 12V, using an inductor ripple of 1.08A (30%), the calculated inductance value is :

$$L = \frac{1.2 \times (12 - 1.2)}{12 \times 500\text{kHz} \times 1.08} = 2\mu\text{H}$$

The ripple current was selected at 1.08A and, as long as we use the calculated 2 $\mu$ H inductance, that should be the actual ripple current amount. The ripple current and required peak current as below :

$$\Delta I_L = \frac{1.2 \times (12 - 1.2)}{12 \times 500\text{kHz} \times 2\mu\text{H}} = 1.08\text{A}$$

$$\text{and } I_{L(PEAK)} = 2.5\text{A} + \frac{1.08}{2} = 3.58\text{A}$$

Inductor saturation current should be chosen over IC's current limit.

### Input Capacitor Selection

The input filter capacitors are needed to smooth out the switched current drawn from the input power source and to reduce voltage ripple on the input. The actual capacitance value is less important than the RMS current rating (and voltage rating, of course). The RMS input ripple current ( $I_{RMS}$ ) is a function of the input voltage, output voltage, and load current :

$$I_{RMS} = I_{OUT(MAX)} \times \frac{V_{OUT}}{V_{IN}} \sqrt{\frac{V_{IN}}{V_{OUT}} - 1}$$

Ceramic capacitors are most often used because of their low cost, small size, high RMS current ratings, and robust surge current capabilities. However, take care when these capacitors are used at the input of circuits supplied by a wall adapter or other supply connected through long, thin wires. Current surges through the inductive wires can induce ringing at the RT7294C input which could potentially cause large, damaging voltage spikes at  $V_{IN}$ . If this phenomenon is observed, some bulk input capacitance may be required. Ceramic capacitors (to meet the RMS current requirement) can be placed in parallel with other types such as tantalum, electrolytic, or polymer (to reduce ringing and overshoot).

Choose capacitors rated at higher temperatures than required. Several ceramic capacitors may be paralleled to meet the RMS current, size, and height requirements of the application. The typical operating circuit use 10 $\mu$ F and one 0.1 $\mu$ F low ESR ceramic capacitors on the input.

## Output Capacitor Selection

The RT7294C is optimized for ceramic output capacitors and best performance will be obtained using them. The total output capacitance value is usually determined by the desired output voltage ripple level and transient response requirements for sag (undershoot on positive load steps) and soar (overshoot on negative load steps).

## Output Ripple

Output ripple at the switching frequency is caused by the inductor current ripple and its effect on the output capacitor's ESR and stored charge. These two ripple components are called ESR ripple and capacitive ripple. Since ceramic capacitors have extremely low ESR and relatively little capacitance, both components are similar in amplitude and both should be considered if ripple is critical.

$$V_{\text{RIPPLE}} = V_{\text{RIPPLE(ESR)}} + V_{\text{RIPPLE(C)}}$$

$$V_{\text{RIPPLE(ESR)}} = \Delta I_L \times R_{\text{ESR}}$$

$$V_{\text{RIPPLE(C)}} = \frac{\Delta I_L}{8 \times C_{\text{OUT}} \times f_{\text{SW}}}$$

For the Typical Operating Circuit for 1.2V output and an inductor ripple of 1.08A, with 22μF output capacitance each with about 5mΩ ESR including PCB trace resistance, the output voltage ripple components are :

$$V_{\text{RIPPLE(ESR)}} = 1.08\text{A} \times 5\text{m}\Omega = 5.4\text{mV}$$

$$V_{\text{RIPPLE(C)}} = \frac{1.08\text{A}}{8 \times 22\mu\text{F} \times 500\text{kHz}} = 12\text{mV}$$

$$V_{\text{RIPPLE}} = 2.7\text{mV} + 12\text{mV} = 14.7\text{mV}$$

## Output Transient Undershoot and Overshoot

In addition to voltage ripple at the switching frequency, the output capacitor and its ESR also affect the voltage sag (undershoot) and soar (overshoot) when the load steps up and down abruptly. The ACOT transient response is very quick and output transients are usually small.

However, the combination of small ceramic output capacitors (with little capacitance), low output voltages (with little stored charge in the output capacitors), and low duty cycle applications (which require high inductance to get reasonable ripple currents with high input voltages) increases the size of voltage variations in response to very quick load changes. Typically, load changes occur slowly with respect to the IC's 500kHz switching frequency.

But some modern digital loads can exhibit nearly instantaneous load changes and the following section shows how to calculate the worst-case voltage swings in response to very fast load steps.

The output voltage transient undershoot and overshoot each have two components : the voltage steps caused by the output capacitor's ESR, and the voltage sag and soar due to the finite output capacitance and the inductor current slew rate. Use the following formulas to check if the ESR is low enough (typically not a problem with ceramic capacitors) and the output capacitance is large enough to prevent excessive sag and soar on very fast load step edges, with the chosen inductor value.

The amplitude of the ESR step up or down is a function of the load step and the ESR of the output capacitor :

$$V_{\text{ESR\_STEP}} = \Delta I_{\text{OUT}} \times R_{\text{ESR}}$$

The amplitude of the capacitive sag is a function of the load step, the output capacitor value, the inductor value, the input-to-output voltage differential, and the maximum duty cycle. The maximum duty cycle during a fast transient is a function of the on-time and the minimum off-time since the ACOT™ control scheme will ramp the current using on-times spaced apart with minimum off-times, which is as fast as allowed. Calculate the approximate on-time (neglecting parasitics) and maximum duty cycle for a given input and output voltage as :

$$t_{\text{ON}} = \frac{V_{\text{OUT}}}{V_{\text{IN}} \times f_{\text{SW}}} \quad \text{and} \quad D_{\text{MAX}} = \frac{t_{\text{ON}}}{t_{\text{ON}} + t_{\text{OFF(MIN)}}}$$

The actual on-time will be slightly longer as the IC compensates for voltage drops in the circuit, but we can neglect both of these since the on-time increase compensates for the voltage losses. Calculate the output voltage sag as :

$$V_{\text{SAG}} = \frac{L \times (\Delta I_{\text{OUT}})^2}{2 \times C_{\text{OUT}} \times (V_{\text{IN(MIN)}} \times D_{\text{MAX}} - V_{\text{OUT}})}$$

The amplitude of the capacitive soar is a function of the load step, the output capacitor value, the inductor value and the output voltage :

$$V_{\text{SOAR}} = \frac{L \times (\Delta I_{\text{OUT}})^2}{2 \times C_{\text{OUT}} \times V_{\text{OUT}}}$$

**Feed-forward Capacitor (C<sub>ff</sub>)**

The RT7294C is optimized for ceramic output capacitors and for low duty cycle applications. However for high-output voltages, with high feedback attenuation, the circuit's response becomes over-damped and transient response can be slowed. In high-output voltage circuits (V<sub>OUT</sub> > 3.3V) transient response is improved by adding a small "feed-forward" capacitor (C<sub>ff</sub>) across the upper FB divider resistor (figure 1), to increase the circuit's Q and reduce damping to speed up the transient response without affecting the steady-state stability of the circuit. Choose a suitable capacitor value that following below step.

- ▶ Get the BW the quickest method to do transient response form no load to full load. Confirm the damping frequency. The damping frequency is BW.

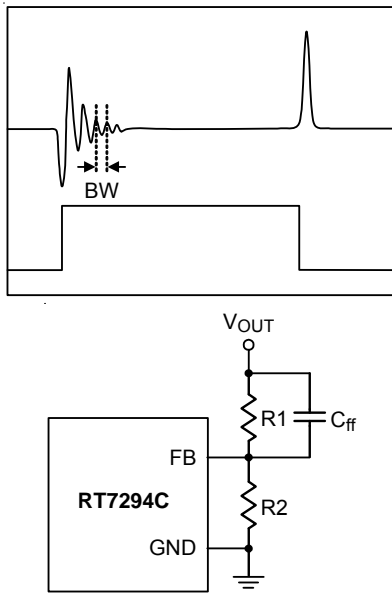

Figure 1. C<sub>ff</sub> Capacitor Setting

- ▶ C<sub>ff</sub> can be calculated base on below equation :

$$C_{ff} = \frac{1}{2 \times 3.1412 \times R1 \times BW \times 0.8}$$

**Internal Soft-Start (SS)**

The RT7294C soft-start uses an internal soft-start time 800μs.

Following below equation to get the minimum capacitance range in order to avoid UV occur.

$$T = \frac{C_{OUT} \times V_{OUT} \times 0.6 \times 1.2}{(I_{LIM} - \text{Load Current}) \times 0.8}$$

$$T \leq 800\mu s$$

**Enable Operation (EN)**

For automatic start-up the EN pin can be connected to V<sub>IN</sub>, through a 100kΩ resistor. Its large hysteresis band makes EN useful for simple delay and timing circuits. EN can be externally pulled to V<sub>IN</sub> by adding a resistor-capacitor delay (R<sub>EN</sub> and C<sub>EN</sub> in Figure 2). Calculate the delay time using EN's internal threshold where switching operation begins (1.4V, typical).

An external MOSFET can be added to implement digital control of EN when no system voltage above 2V is available (Figure 3). In this case, a 100kΩ pull-up resistor, R<sub>EN</sub>, is connected between V<sub>IN</sub> and the EN pin. MOSFET Q1 will be under logic control to pull down the EN pin. To prevent enabling circuit when V<sub>IN</sub> is smaller than the V<sub>OUT</sub> target value or some other desired voltage level, a resistive voltage divider can be placed between the input voltage and ground and connected to EN to create an additional input under voltage lockout threshold (Figure 4).

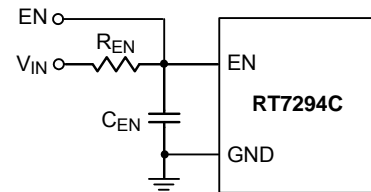

Figure 2. External Timing Control

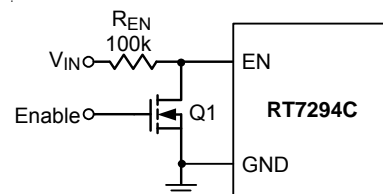

Figure 3. Digital Enable Control Circuit

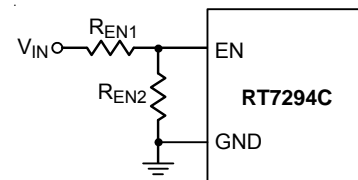

Figure 4. Resistor Divider for Lockout Threshold Setting

### Output Voltage Setting

Set the desired output voltage using a resistive divider from the output to ground with the midpoint connected to FB. The output voltage is set according to the following equation :

$$V_{OUT} = 0.6 \times (1 + R1 / R2)$$

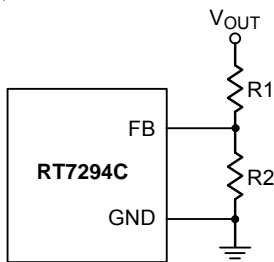

Figure 5. Output Voltage Setting

Place the FB resistors within 5mm of the FB pin. Choose R2 between 10kΩ and 100kΩ to minimize power consumption without excessive noise pick-up and calculate R1 as follows :

$$R1 = \frac{R2 \times (V_{OUT} - 0.6)}{0.6}$$

For output voltage accuracy, use divider resistors with 1% or better tolerance.

### External BOOT Bootstrap Diode

When the input voltage is lower than 5.5V it is recommended to add an external bootstrap diode between VIN (or VINR) and the BOOT pin to improve enhancement of the internal MOSFET switch and improve efficiency. The bootstrap diode can be a low cost one such as 1N4148 or BAT54.

### External BOOT Capacitor Series Resistance

The internal power MOSFET switch gate driver is optimized to turn the switch on fast enough for low power loss and good efficiency, but also slow enough to reduce EMI. Switch turn-on is when most EMI occurs since VSW rises rapidly. During switch turn-off, SW is discharged relatively slowly by the inductor current during the deadtime between high-side and low-side switch on-times. In some cases it is desirable to reduce EMI further, at the expense of some additional power dissipation. The switch

turn-on can be slowed by placing a small (<47Ω) resistance between BOOT and the external bootstrap capacitor. This will slow the high-side switch turn-on and VSW's rise. To remove the resistor from the capacitor charging path (avoiding poor enhancement due to undercharging the BOOT capacitor), use the external diode shown in figure 6 to charge the BOOT capacitor and place the resistance between BOOT and the capacitor/diode connection.

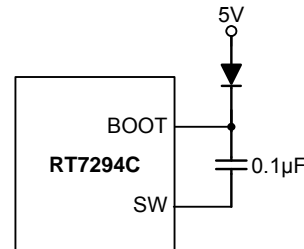

Figure 6. External Bootstrap Diode

### Over-Temperature Protection

The RT7294C features an Over-Temperature Protection (OTP) circuitry to prevent from overheating due to excessive power dissipation. The OTP will shut down switching operation when junction temperature exceeds 160°C. Once the junction temperature cools down by approximately 20°C, the converter will resume operation. To maintain continuous operation, the maximum junction temperature should be lower than 125°C.

### Under-Voltage Protection

#### Hiccup Mode

The RT7294C provides Hiccup Mode Under-Voltage Protection (UVP). When the VFB voltage drops below 0.4V, the UVP function will be triggered to shut down switching operation. If the UVP condition remains for a period, the RT7294C will retry automatically. When the UVP condition is removed, the converter will resume operation. The UVP is disabled during soft-start period.

### Thermal Considerations

For continuous operation, do not exceed absolute maximum junction temperature. The maximum power dissipation depends on the thermal resistance of the IC package, PCB layout, rate of surrounding airflow, and



## Outline Dimension

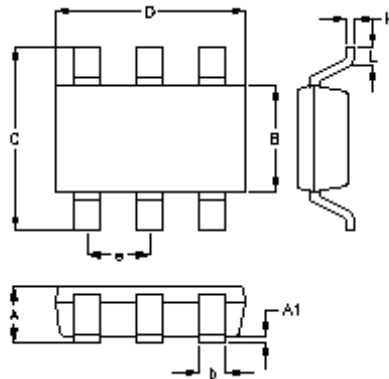

Symbol	Dimensions In Millimeters		Dimensions In Inches	
	Min.	Max.	Min.	Max.
A	0.700	1.000	0.028	0.039
A1	0.000	0.100	0.000	0.004
B	1.397	1.803	0.055	0.071
b	0.300	0.559	0.012	0.022
C	2.591	3.000	0.102	0.118
D	2.692	3.099	0.106	0.122
e	0.950		0.037	
H	0.080	0.254	0.003	0.010
L	0.300	0.610	0.012	0.024

### TSOT-23-6 (FC) Surface Mount Package

## Richtek Technology Corporation

14F, No. 8, Tai Yuen 1<sup>st</sup> Street, Chupei City

Hsinchu, Taiwan, R.O.C.

Tel: (8863)5526789

Richtek products are sold by description only. Richtek reserves the right to change the circuitry and/or specifications without notice at any time. Customers should obtain the latest relevant information and data sheets before placing orders and should verify that such information is current and complete. Richtek cannot assume responsibility for use of any circuitry other than circuitry entirely embodied in a Richtek product. Information furnished by Richtek is believed to be accurate and reliable. However, no responsibility is assumed by Richtek or its subsidiaries for its use; nor for any infringements of patents or other rights of third parties which may result from its use. No license is granted by implication or otherwise under any patent or patent rights of Richtek or its subsidiaries.