

# MAX5700/MAX5701/ MAX5702

# Ultra-Small, Dual-Channel, 8-/10-/12-Bit Buffered Output DACs with Internal Reference and SPI Interface

## General Description

The MAX5700/MAX5701/MAX5702 2-channel, low-power, 8-/10-/12-bit, voltage-output digital-to-analog converters (DACs) include output buffers and an internal reference that is selectable to be 2.048V, 2.500V, or 4.096V. The MAX5700/MAX5701/MAX5702 accept a wide supply voltage range of 2.7V to 5.5V with extremely low power (1.5mW) consumption to accommodate most low-voltage applications. A precision external reference input allows rail-to-rail operation and presents a 100k $\Omega$  (typ) load to an external reference.

The MAX5700/MAX5701/MAX5702 have an a 50MHz 3-wire SPI/QSPI™/MICROWIRE®/DSP-compatible serial interface. The DAC output is buffered and has a low supply current of less than 250 $\mu$ A per channel and a low offset error of  $\pm 0.5$ mV (typ). On power-up, the MAX5700/MAX5701/MAX5702 reset the DAC outputs to zero, providing additional safety for applications that drive valves or other transducers which need to be off on power-up. The internal reference is initially powered down to allow use of an external reference. The MAX5700/MAX5701/MAX5702 allow simultaneous output updates using software LOAD commands.

A clear logic input ( $\overline{\text{CLR}}$ ) allows the contents of the CODE and the DAC registers to be cleared asynchronously and sets the DAC outputs to zero. The MAX5700/MAX5701/MAX5702 are available in a 10-pin  $\mu$ MAX® and an ultra-small, 10-pin TDFN package and are specified over the -40°C to +125°C temperature range.

## Applications

- Programmable Voltage and Current Sources
- Gain and Offset Adjustment
- Automatic Tuning and Optical Control
- Power Amplifier Control and Biasing
- Process Control and Servo Loops
- Portable Instrumentation
- Data Acquisition

**Ordering Information** appears at end of data sheet.

QSPI is a trademark of Motorola, Inc.

MICROWIRE is a registered trademark of National Semiconductor Corporation.

$\mu$ MAX is a registered trademark of Maxim Integrated Products, Inc.

## Benefits and Features

- Two High-Accuracy DAC Channels
  - 12-Bit Accuracy Without Adjustment
  - $\pm 1$  LSB INL Buffered Voltage Output
  - Monotonic Over All Operating Conditions
  - Independent Mode Settings for Each DAC
- Three Precision Selectable Internal References
  - 2.048V, 2.500V, or 4.096V
- Internal Output Buffer
  - Rail-to-Rail Operation with External Reference
  - 4.5 $\mu$ s Settling Time
  - Outputs Directly Drive 2k $\Omega$  Loads
- Small 5mm x 3mm 10-Pin  $\mu$ MAX or Ultra-Small 3mm x 3mm 10-Pin TDFN Package
- Wide 2.7V to 5.5V Supply Range
- Separate 1.8V to 5.5V  $V_{\text{DDIO}}$  Power-Supply Input
- 50MHz 3-Wire SPI/QSPI/MICROWIRE/DSP Compatible Serial Interface
- Power-On-Reset to Zero-Scale DAC Output
- $\overline{\text{CLR}}$  For Asynchronous Control
- Three Software-Selectable Power-Down Output Impedances
  - 1k $\Omega$ , 100k $\Omega$ , or High Impedance
- Low 350 $\mu$ A Supply Current at 3V  $V_{\text{DD}}$

## Functional Diagram

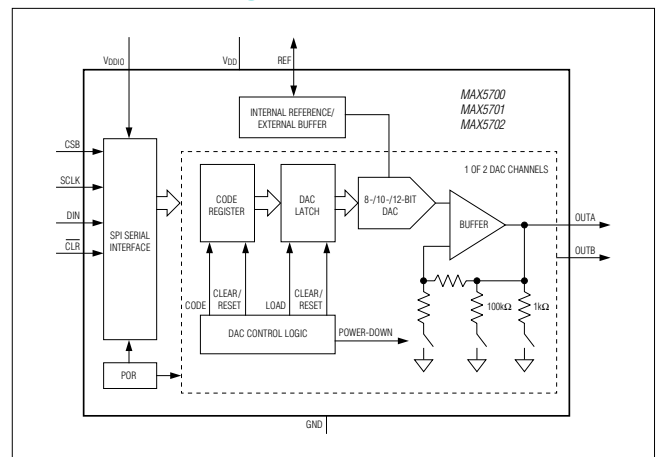

MAX5700/MAX5701/  
MAX5702

Ultra-Small, Dual-Channel, 8-/10-/12-Bit Buffered  
Output DACs with Internal Reference  
and SPI Interface

**Absolute Maximum Ratings**

V <sub>DD</sub> , V <sub>DDIO</sub> to GND .....	-0.3V to +6V	Maximum Continuous Current into Any Pin .....	±50mA
OUT <sub>-</sub> , REF to GND....	-0.3V to the lower of (V <sub>DD</sub> + 0.3V) and +6V	Operating Temperature Range .....	-40°C to +125°C
CSB, SCLK, CLR to GND .....	-0.3V to +6V	Storage Temperature Range.....	-65°C to +150°C
DIN to GND .....	-0.3V to the lower of (V <sub>DDIO</sub> + 0.3V) and +6V	Lead Temperature (soldering, 10s) .....	+300°C
Continuous Power Dissipation (T <sub>A</sub> = +70°C)		Soldering Temperature (reflow) .....	+260°C
μMAX (derate at 8.8mW/°C above 70°C).....	707mW		
TDFN (derate at 24.4mW/°C above 70°C).....	1951mW		

Stresses beyond those listed under "Absolute Maximum Ratings" may cause permanent damage to the device. These are stress ratings only, and functional operation of the device at these or any other conditions beyond those indicated in the operational sections of the specifications is not implied. Exposure to absolute maximum rating conditions for extended periods may affect device reliability.

**Package Thermal Characteristics (Note 1)**

μMAX	Junction-to-Ambient Thermal Resistance (θ <sub>JA</sub> ) .....	113°C/W	TDFN	Junction-to-Ambient Thermal Resistance (θ <sub>JA</sub> ) .....	41°C/W
	Junction-to-Case Thermal Resistance (θ <sub>JC</sub> ).....	42°C/W		Junction-to-Case Thermal Resistance (θ <sub>JC</sub> ) .....	9°C/W

**Note 1:** Package thermal resistances were obtained using the method described in JEDEC specification JESD51-7, using a four-layer board. For detailed information on package thermal considerations, refer to [www.maximintegrated.com/thermal-tutorial](http://www.maximintegrated.com/thermal-tutorial).

**Electrical Characteristics**

(V<sub>DD</sub> = 2.7V to 5.5V, V<sub>DDIO</sub> = 1.8V to 5.5V, V<sub>GND</sub> = 0V, C<sub>L</sub> = 200pF, R<sub>L</sub> = 2kΩ, T<sub>A</sub> = -40°C to +125°C, unless otherwise noted. Typical values are at T<sub>A</sub> = +25°C.) (Note 2)

PARAMETER	SYMBOL	CONDITIONS	MIN	TYP	MAX	UNITS
<b>DC PERFORMANCE (Note 3)</b>						
Resolution and Monotonicity	N	MAX5700	8			Bits
		MAX5701	10			
		MAX5702	12			
Integral Nonlinearity (Note 4)	INL	MAX5700	-0.25	±0.05	+0.25	LSB
		MAX5701	-0.5	±0.25	+0.5	
		MAX5702	-1	±0.5	+1	
Differential Nonlinearity (Note 4)	DNL	MAX5700	-0.25	±0.05	+0.25	LSB
		MAX5701	-0.5	±0.1	+0.5	
		MAX5702	-1	±0.2	+1	
Offset Error (Note 5)	OE		-5	±0.5	+5	mV
Offset Error Drift				±10		μV/°C
Gain Error (Note 5)	GE		-1.0	±0.1	+1.0	%FS
Gain Temperature Coefficient		With respect to V <sub>REF</sub>		±3.0		ppm of FS/°C
Zero-Scale Error			0		10	mV
Full-Scale Error		With respect to V <sub>REF</sub>	-0.5		+0.5	%FS

**Electrical Characteristics (continued)**

( $V_{DD} = 2.7V$  to  $5.5V$ ,  $V_{DDIO} = 1.8V$  to  $5.5V$ ,  $V_{GND} = 0V$ ,  $C_L = 200pF$ ,  $R_L = 2k\Omega$ ,  $T_A = -40^\circ C$  to  $+125^\circ C$ , unless otherwise noted. Typical values are at  $T_A = +25^\circ C$ .) (Note 2)

PARAMETER	SYMBOL	CONDITIONS		MIN	TYP	MAX	UNITS
<b>DAC OUTPUT CHARACTERISTICS</b>							
Output Voltage Range (Note 6)		No load		0		$V_{DD}$	V
		2k $\Omega$ load to GND		0		$V_{DD} - 0.2$	
		2k $\Omega$ load to $V_{DD}$		0.2		$V_{DD}$	
Load Regulation		$V_{OUT} = V_{FS}/2$	$V_{DD} = 3V \pm 10\%$ , $ I_{OUT}  \leq 5mA$		300		$\mu V/mA$
			$V_{DD} = 5V \pm 10\%$ , $ I_{OUT}  \leq 10mA$		300		
DC Output Impedance		$V_{OUT} = V_{FS}/2$	$V_{DD} = 3V \pm 10\%$ , $ I_{OUT}  \leq 5mA$		0.3		$\Omega$
			$V_{DD} = 5V \pm 10\%$ , $ I_{OUT}  \leq 10mA$		0.3		
Maximum Capacitive Load Handling	$C_L$				500		pF
Resistive Load Handling	$R_L$			2			k $\Omega$
Short-Circuit Output Current		$V_{DD} = 5.5V$	Sourcing (output shorted to GND)		30		mA
			Sinking (output shorted to $V_{DD}$ )		50		
DC Power-Supply Rejection		$V_{DD} = 3V \pm 10\%$ or $5V \pm 10\%$			100		$\mu V/V$
<b>DYNAMIC PERFORMANCE</b>							
Voltage-Output Slew Rate	SR	Positive and negative			1.0		V/ $\mu s$
Voltage-Output Settling Time		$1/4$ scale to $3/4$ scale, to $\leq 1$ LSB, MAX5700			2.2		$\mu s$
		$1/4$ scale to $3/4$ scale, to $\leq 1$ LSB, MAX5701			2.6		
		$1/4$ scale to $3/4$ scale, to $\leq 1$ LSB, MAX5702			4.5		
DAC Glitch Impulse		Major code transition			7		nV*s
Channel-to-Channel Feedthrough (Note 7)		External reference			3.5		nV*s
		Internal reference			3.3		
Digital Feedthrough		Code = 0, all digital inputs from 0V to $V_{DDIO}$			0.2		nV*s
Power-Up Time		Startup calibration time (Note 8)			200		$\mu s$
		From power-down			50		$\mu s$

**Electrical Characteristics (continued)**

(V<sub>DD</sub> = 2.7V to 5.5V, V<sub>DDIO</sub> = 1.8V to 5.5V, V<sub>GND</sub> = 0V, C<sub>L</sub> = 200pF, R<sub>L</sub> = 2kΩ, T<sub>A</sub> = -40°C to +125°C, unless otherwise noted. Typical values are at T<sub>A</sub> = +25°C.) (Note 2)

PARAMETER	SYMBOL	CONDITIONS		MIN	TYP	MAX	UNITS
Output Voltage-Noise Density (DAC Output at Midscale)		External reference	f = 1kHz		90		nV/√Hz
			f = 10kHz		82		
		2.048V internal reference	f = 1kHz		112		
			f = 10kHz		102		
		2.5V internal reference	f = 1kHz		125		
			f = 10kHz		110		
		4.096V internal reference	f = 1kHz		160		
			f = 10kHz		145		
Integrated Output Noise (DAC Output at Midscale)		External reference	f = 0.1Hz to 10Hz		12		μV <sub>P-P</sub>
			f = 0.1Hz to 10kHz		76		
			f = 0.1Hz to 300kHz		385		
		2.048V internal reference	f = 0.1Hz to 10Hz		14		
			f = 0.1Hz to 10kHz		91		
			f = 0.1Hz to 300kHz		450		
		2.5V internal reference	f = 0.1Hz to 10Hz		15		
			f = 0.1Hz to 10kHz		99		
			f = 0.1Hz to 300kHz		470		
		4.096V internal reference	f = 0.1Hz to 10Hz		16		
			f = 0.1Hz to 10kHz		124		
			f = 0.1Hz to 300kHz		490		
Output Voltage-Noise Density (DAC Output at Full Scale)		External reference	f = 1kHz		114		nV/√Hz
			f = 10kHz		99		
		2.048V internal reference	f = 1kHz		175		
			f = 10kHz		153		
		2.5V internal reference	f = 1kHz		200		
			f = 10kHz		174		
		4.096V internal reference	f = 1kHz		295		
			f = 10kHz		255		
Integrated Output Noise (DAC Output at Full Scale)		External reference	f = 0.1Hz to 10Hz		13		μV <sub>P-P</sub>
			f = 0.1Hz to 10kHz		94		
			f = 0.1Hz to 300kHz		540		
		2.048V internal reference	f = 0.1Hz to 10Hz		19		
			f = 0.1Hz to 10kHz		143		
			f = 0.1Hz to 300kHz		685		
		2.5V internal reference	f = 0.1Hz to 10Hz		21		
			f = 0.1Hz to 10kHz		159		
			f = 0.1Hz to 300kHz		705		
		4.096V internal reference	f = 0.1Hz to 10Hz		26		
			f = 0.1Hz to 10kHz		213		
			f = 0.1Hz to 300kHz		750		

**Electrical Characteristics (continued)**

( $V_{DD} = 2.7V$  to  $5.5V$ ,  $V_{DDIO} = 1.8V$  to  $5.5V$ ,  $V_{GND} = 0V$ ,  $C_L = 200pF$ ,  $R_L = 2k\Omega$ ,  $T_A = -40^\circ C$  to  $+125^\circ C$ , unless otherwise noted. Typical values are at  $T_A = +25^\circ C$ .) (Note 2)

PARAMETER	SYMBOL	CONDITIONS	MIN	TYP	MAX	UNITS
<b>REFERENCE INPUT</b>						
Reference Input Range	$V_{REF}$		1.24		$V_{DD}$	V
Reference Input Current	$I_{REF}$	$V_{REF} = V_{DD} = 5.5V$		55	74	$\mu A$
Reference Input Impedance	$R_{REF}$		75	100		$k\Omega$
<b>REFERENCE OUTPUT</b>						
Reference Output Voltage	$V_{REF}$	$V_{REF} = 2.048V, T_A = +25^\circ C$	2.043	2.048	2.053	V
		$V_{REF} = 2.5V, T_A = +25^\circ C$	2.494	2.500	2.506	
		$V_{REF} = 4.096V, T_A = +25^\circ C$	4.086	4.096	4.106	
Reference Output Noise Density		$V_{REF} = 2.048V$	f = 1kHz	129		nV/ $\sqrt{Hz}$
			f = 10kHz	122		
		$V_{REF} = 2.500V$	f = 1kHz	158		
			f = 10kHz	151		
		$V_{REF} = 4.096V$	f = 1kHz	254		
			f = 10kHz	237		
Integrated Reference Output Noise		$V_{REF} = 2.048V$	f = 0.1Hz to 10Hz	12		$\mu V_{P-P}$
			f = 0.1Hz to 10kHz	110		
			f = 0.1Hz to 300kHz	390		
		$V_{REF} = 2.500V$	f = 0.1Hz to 10Hz	15		
			f = 0.1Hz to 10kHz	129		
			f = 0.1Hz to 300kHz	430		
		$V_{REF} = 4.096V$	f = 0.1Hz to 10Hz	20		
			f = 0.1Hz to 10kHz	205		
			f = 0.1Hz to 300kHz	525		
Reference Temperature Coefficient (Note 9)		MAX5702A	$\pm 3$	$\pm 10$		ppm/ $^\circ C$
		MAX5700/MAX5701/MAX5702B	$\pm 10$	$\pm 25$		
Reference Drive Capacity		External load		25		$k\Omega$
Reference Capacitive Load				200		pF
Reference Load Regulation		$I_{SOURCE} = 0$ to $500\mu A$		2		mV/mA
Reference Line Regulation				0.05		mV/V
<b>POWER REQUIREMENTS</b>						
Supply Voltage	$V_{DD}$	$V_{REF} = 4.096V$	4.5		5.5	V
		All other options	2.7		5.5	
I/O Supply Voltage	$V_{DDIO}$		1.8		5.5	V

MAX5700/MAX5701/  
MAX5702

Ultra-Small, Dual-Channel, 8-/10-/12-Bit Buffered  
Output DACs with Internal Reference  
and SPI Interface

Electrical Characteristics (continued)

( $V_{DD} = 2.7V$  to  $5.5V$ ,  $V_{DDIO} = 1.8V$  to  $5.5V$ ,  $V_{GND} = 0V$ ,  $C_L = 200pF$ ,  $R_L = 2k\Omega$ ,  $T_A = -40^\circ C$  to  $+125^\circ C$ , unless otherwise noted. Typical values are at  $T_A = +25^\circ C$ .) (Note 2)

PARAMETER	SYMBOL	CONDITIONS	MIN	TYP	MAX	UNITS
Supply Current (Note 10)	$I_{DD}$	Internal reference	$V_{REF} = 2.048V$	0.55	0.75	mA
			$V_{REF} = 2.5V$	0.60	0.80	
			$V_{REF} = 4.096V$	0.65	0.90	
		External reference	$V_{REF} = 3V$	0.40	0.60	
			$V_{REF} = 5V$	0.55	0.75	
Interface Supply Current (Note 10)	$I_{DDIO}$			1	$\mu A$	
Power-Down Mode Supply Current	$I_{PD}$	All DACs off, internal reference ON		140		$\mu A$
		All DACs off, internal reference OFF, $T_A = -40^\circ C$ to $+85^\circ C$		0.5	1	
		All DACs off, internal reference OFF, $T_A = +125^\circ C$		1.2	2.5	
<b>DIGITAL INPUT CHARACTERISTICS (CSB, SCLK, DIN, <math>\overline{CLR}</math>)</b>						
Hysteresis Voltage	$V_H$			0.15		V
Input High Voltage	$V_{IH}$	$2.2V < V_{DDIO} < 5.5V$		$0.7 \times V_{DDIO}$		V
		$1.8V < V_{DDIO} < 2.2V$		$0.8 \times V_{DDIO}$		
Input Low Voltage	$V_{IL}$	$2.2V < V_{DDIO} < 5.5V$			$0.3 \times V_{DDIO}$	V
		$1.8V < V_{DDIO} < 2.2V$			$0.2 \times V_{DDIO}$	
Input Leakage Current	$I_{IN}$	$V_{IN} = 0V$ or $V_{DDIO}$ (Note 10)		$\pm 0.1$	$\pm 1$	$\mu A$
Input Capacitance (Note 10)	$C_{IN}$			3		pF
<b>SPI TIMING CHARACTERISTICS (CSB, SCLK, DIN, <math>\overline{CLR}</math>) (Note 11)</b>						
SCLK Frequency	$f_{SCLK}$	$2.7V < V_{DDIO} < 5.5V$			50	MHz
		$1.8V < V_{DDIO} < 2.7V$			33	
SCLK Period	$t_{SCLK}$	$2.7V < V_{DDIO} < 5.5V$		20		ns
		$1.8V < V_{DDIO} < 2.7V$		30		
SCLK Pulse Width High	$t_{CH}$			8		ns
SCLK Pulse Width Low	$t_{CL}$			8		ns
CSB Fall to SCLK Fall Setup Time	$t_{CSS0}$	To first SCLK falling edge		8		ns
CSB Fall to SCLK Fall Hold Time	$t_{CSH0}$	Applies to inactive SCLK falling edge preceding the first SCLK falling edge		0		ns
CSB Rise to SCLK Fall Hold Time	$t_{CSH1}$	Applies to the 24th SCLK falling edge		0		ns

### Electrical Characteristics (continued)

( $V_{DD} = 2.7V$  to  $5.5V$ ,  $V_{DDIO} = 1.8V$  to  $5.5V$ ,  $V_{GND} = 0V$ ,  $C_L = 200pF$ ,  $R_L = 2k\Omega$ ,  $T_A = -40^\circ C$  to  $+125^\circ C$ , unless otherwise noted. Typical values are at  $T_A = +25^\circ C$ .) (Note 2)

PARAMETER	SYMBOL	CONDITIONS	MIN	TYP	MAX	UNITS
CSB Rise to SCLK Fall	$t_{CSA}$	Applies to the 24th SCLK falling edge, aborted sequence	12			ns
SCLK Fall to CSB Fall	$t_{CSF}$	Applies to 24th SCLK falling edge	100			ns
CSB Pulse Width High	$t_{CSPW}$		20			ns
DIN to SCLK Fall Setup Time	$t_{DS}$		5			ns
DIN to SCLK Fall Hold Time	$t_{DH}$		4.5			ns
$\overline{CLR}$ Pulse Width Low	$t_{CLPW}$		20			ns
$\overline{CLR}$ Rise to CSB Fall	$t_{CSC}$	Required for command to be executed	20			ns

**Note 2:** Electrical specifications are production tested at  $T_A = +25^\circ C$ . Specifications over the entire operating temperature range are guaranteed by design and characterization. Typical specifications are at  $T_A = +25^\circ C$ .

**Note 3:** DC Performance is tested without load.

**Note 4:** Linearity is tested with unloaded outputs to within 20mV of GND and  $V_{DD}$ .

**Note 5:** Offset and gain calculated from measurements made with  $V_{REF} = V_{DD}$  at code 30 and 4065 for MAX5702, code 8 and 1016 for MAX5701, and code 2 and 254 for MAX5700.

**Note 6:** Subject to zero and full-scale error limits and  $V_{REF}$  settings.

**Note 7:** Measured with all other DAC outputs at midscale with one channel transitioning 0 to full scale.

**Note 8:** On power-up, the device initiates an internal 200 $\mu s$  (typ) calibration sequence. All commands issued during this time will be ignored.

**Note 9:** Guaranteed by design.

**Note 10:** All channels active at  $V_{FS}$ , unloaded. Static logic inputs with  $V_{IL} = V_{GND}$  and  $V_{IH} = V_{DDIO}$ .

**Note 11:** All timing tested with  $V_{IL} = V_{GND}$  and  $V_{IH} = V_{DDIO}$ .

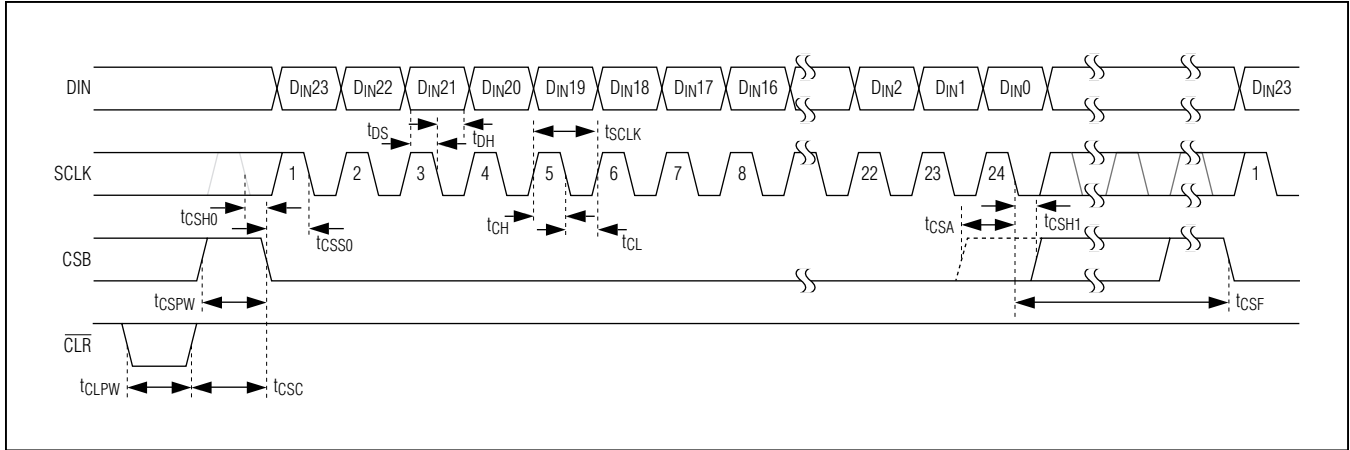
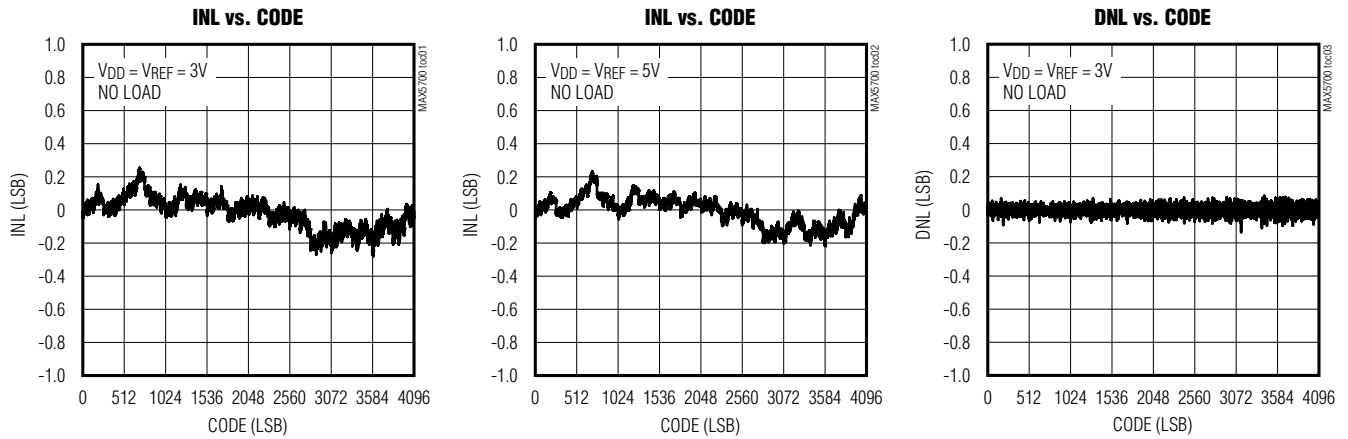

Figure 1. SPI Serial Interface Timing Diagram

## Typical Operating Characteristics

(MAX5702, 12-bit performance, T<sub>A</sub> = +25°C, unless otherwise noted.)





Typical Operating Characteristics (continued)

(MAX5702, 12-bit performance,  $T_A = +25^\circ\text{C}$ , unless otherwise noted.)

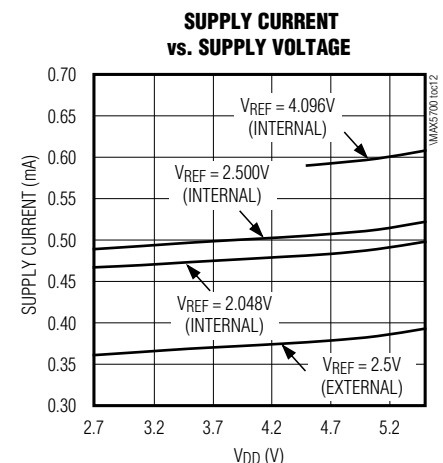
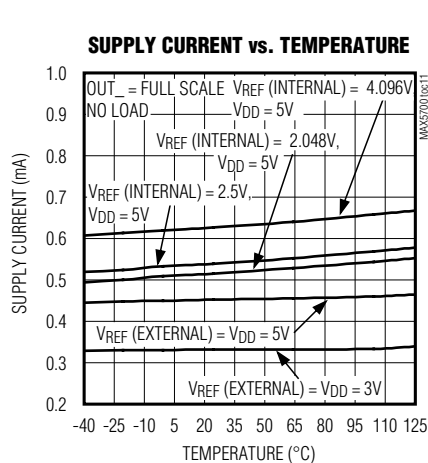
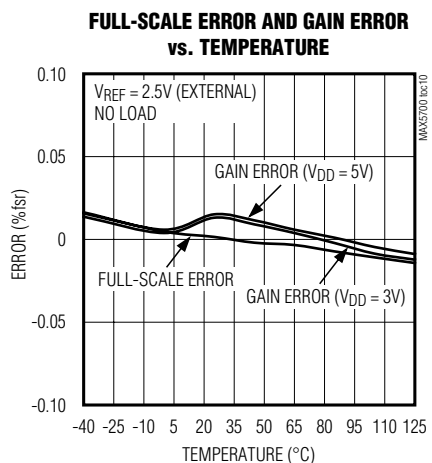
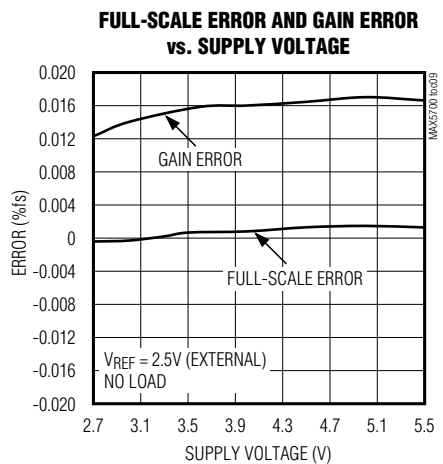
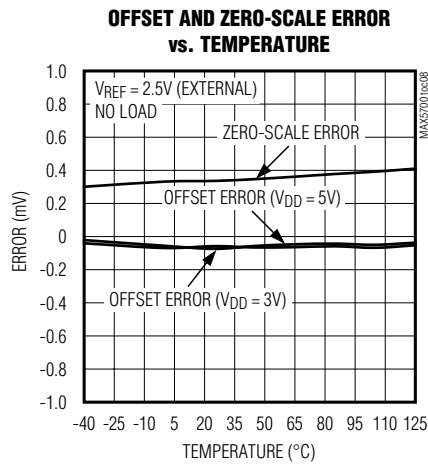
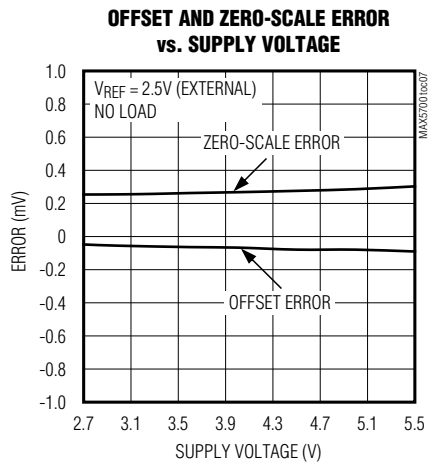
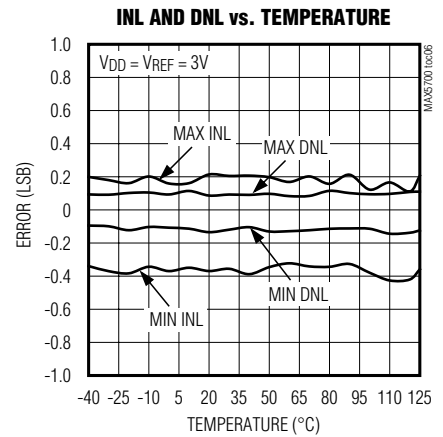
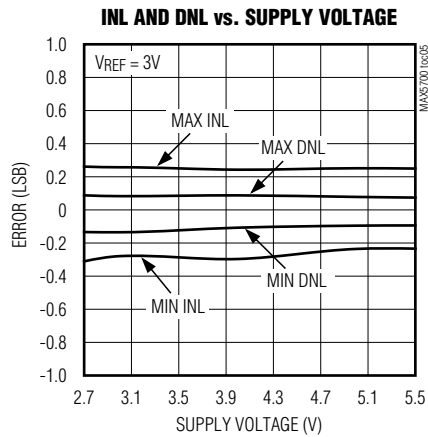
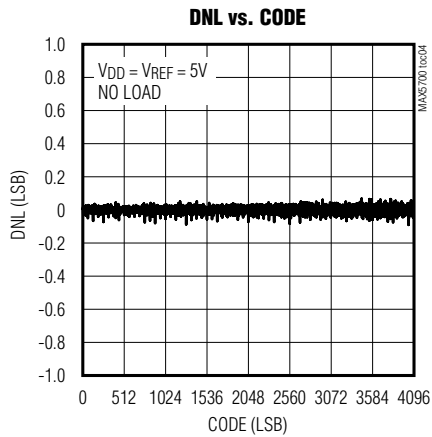

Typical Operating Characteristics (continued)

(MAX5702, 12-bit performance,  $T_A = +25^\circ\text{C}$ , unless otherwise noted.)

POWER-DOWN MODE SUPPLY CURRENT vs. TEMPERATURE

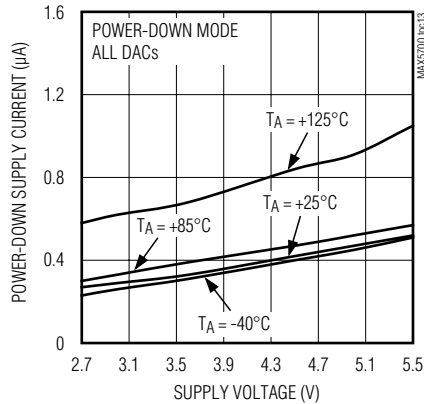

SUPPLY CURRENT vs. CODE

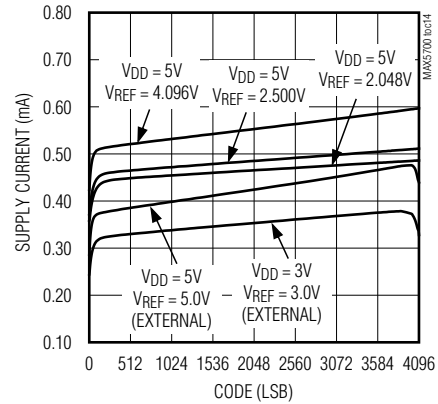

IREF (EXTERNAL) vs. CODE

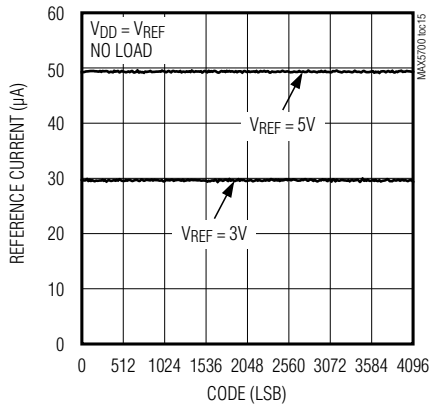

SETTLING TO  $\pm 1$  LSB  
( $V_{DD} = V_{REF} = 5\text{V}$ ,  $R_L = 2\text{k}\Omega$ ,  $C_L = 200\text{pF}$ )

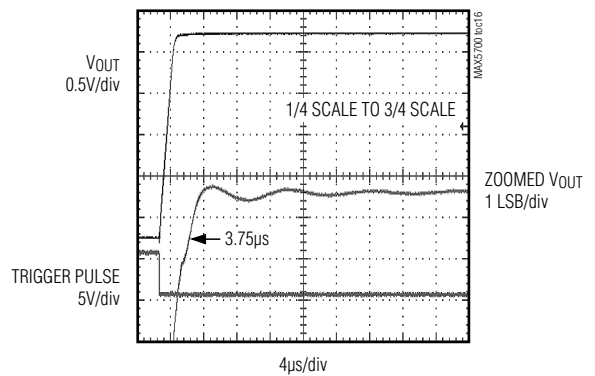

SETTLING TO  $\pm 1$  LSB  
( $V_{DD} = V_{REF} = 5\text{V}$ ,  $R_L = 2\text{k}\Omega$ ,  $C_L = 200\text{pF}$ )

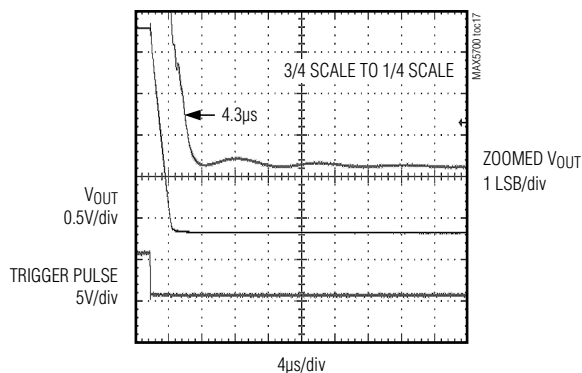

MAJOR CODE TRANSITION GLITCH ENERGY  
( $V_{DD} = V_{REF} = 5\text{V}$ ,  $R_L = 2\text{k}\Omega$ ,  $C_L = 200\text{pF}$ )

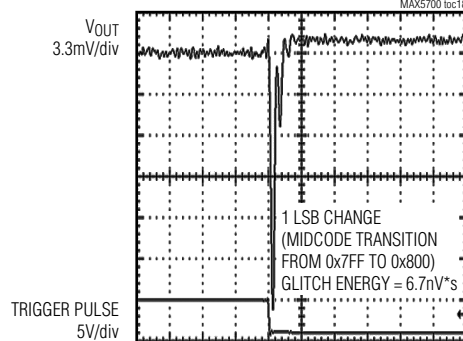

Typical Operating Characteristics (continued)

(MAX5702, 12-bit performance,  $T_A = +25^\circ\text{C}$ , unless otherwise noted.)

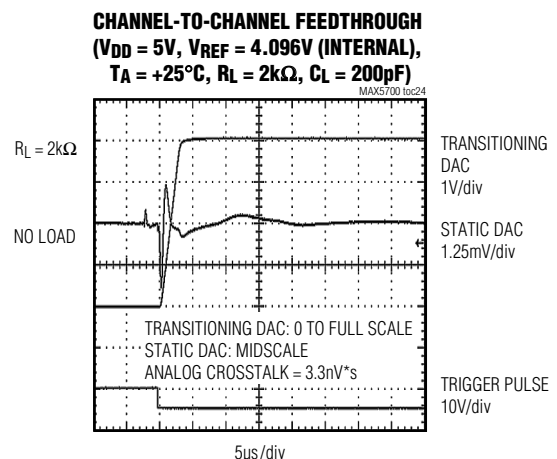
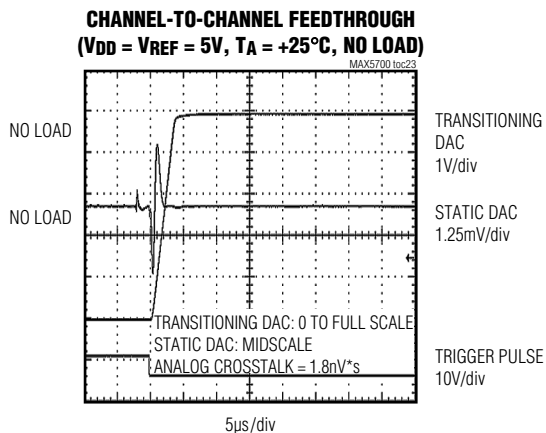
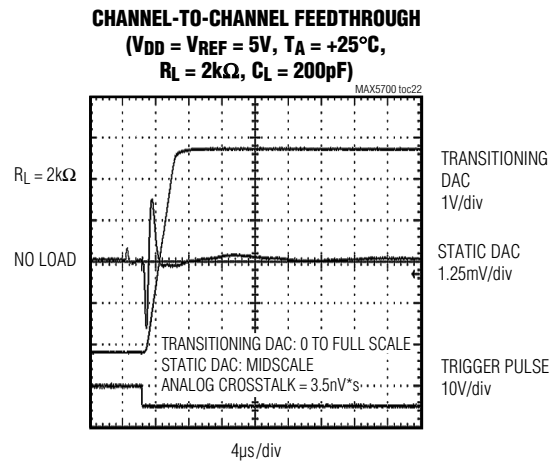
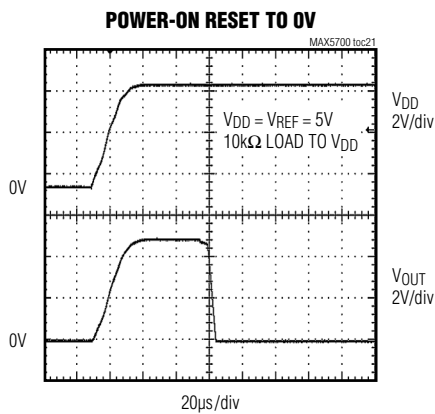
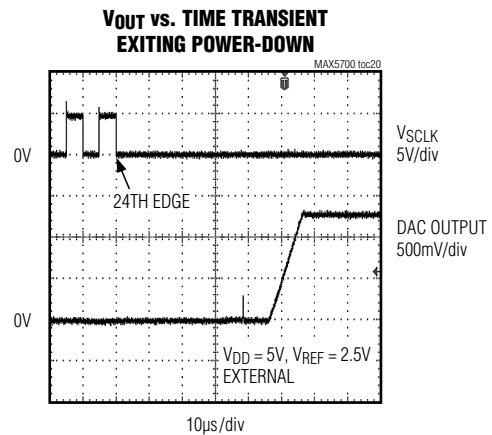
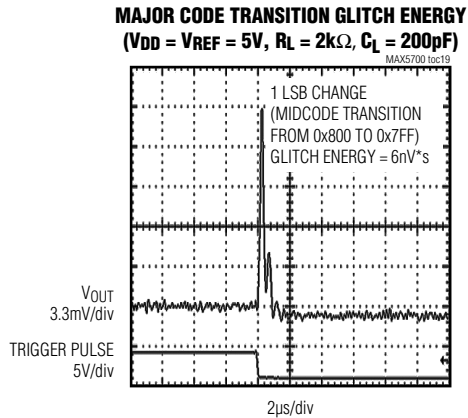

Typical Operating Characteristics (continued)

(MAX5702, 12-bit performance,  $T_A = +25^\circ\text{C}$ , unless otherwise noted.)

**CHANNEL-TO-CHANNEL FEEDTHROUGH**  
( $V_{DD} = 5\text{V}$ ,  $V_{REF} = 4.096\text{V}$  (INTERNAL),  
 $T_A = +25^\circ\text{C}$ , NO LOAD)

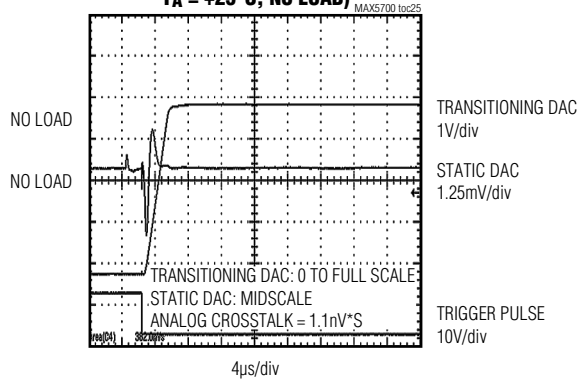

**DIGITAL FEEDTHROUGH**

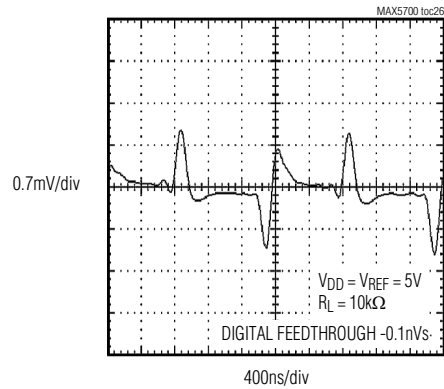

**OUTPUT LOAD REGULATION**

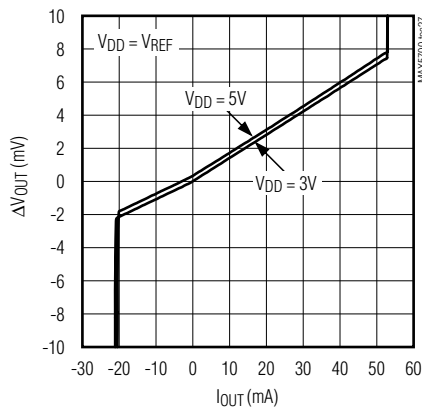

**OUTPUT CURRENT LIMITING**

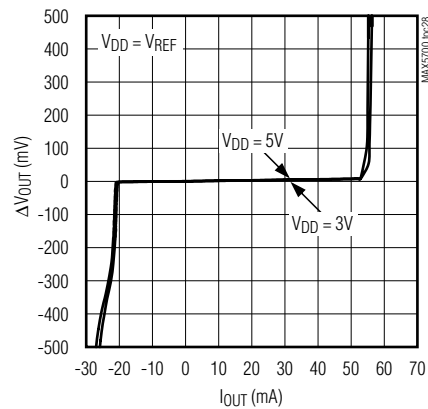

**HEADROOM AT RAILS**  
vs. OUTPUT CURRENT

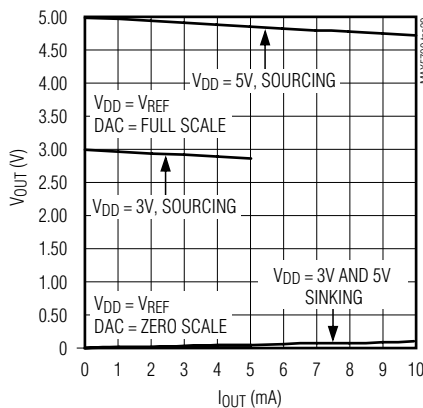

**NOISE-VOLTAGE DENSITY**  
vs. FREQUENCY (DAC AT MIDSCALE)

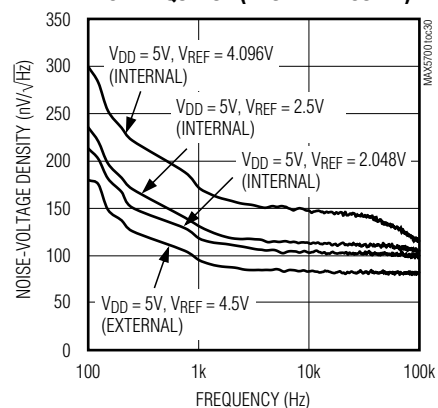

**Typical Operating Characteristics (continued)**

(MAX5702, 12-bit performance,  $T_A = +25^\circ\text{C}$ , unless otherwise noted.)

**0.1Hz TO 10Hz OUTPUT NOISE, EXTERNAL  
REFERENCE ( $V_{DD} = 5\text{V}$ ,  $V_{REF} = 4.5\text{V}$ )**

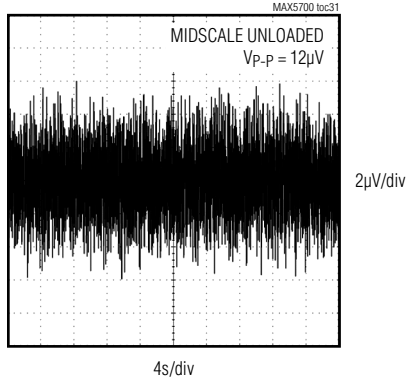

**0.1Hz TO 10Hz OUTPUT NOISE, INTERNAL  
REFERENCE ( $V_{DD} = 5\text{V}$ ,  $V_{REF} = 2.048\text{V}$ )**

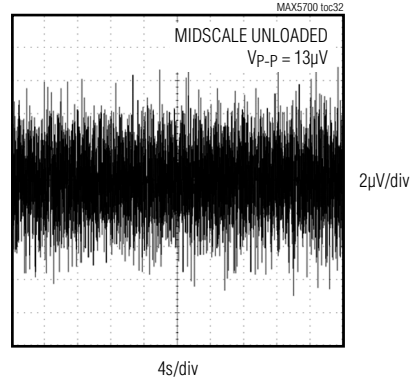

**0.1Hz TO 10Hz OUTPUT NOISE, INTERNAL  
REFERENCE ( $V_{DD} = 5\text{V}$ ,  $V_{REF} = 2.5\text{V}$ )**

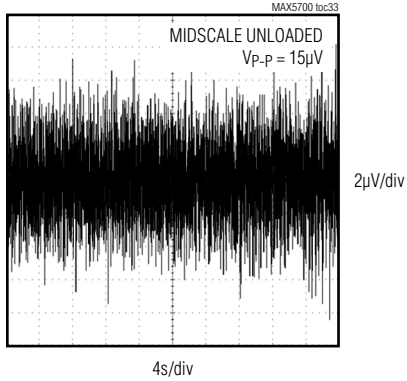

**0.1Hz TO 10Hz OUTPUT NOISE, INTERNAL  
REFERENCE ( $V_{DD} = 5\text{V}$ ,  $V_{REF} = 4.096\text{V}$ )**

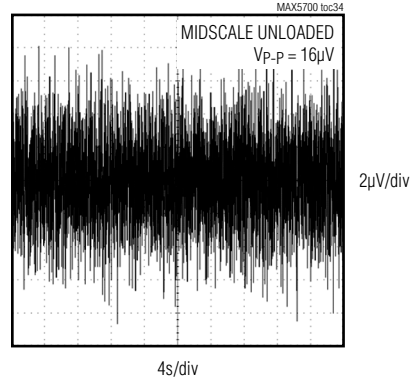

**$V_{REF}$  DRIFT vs. TEMPERATURE**

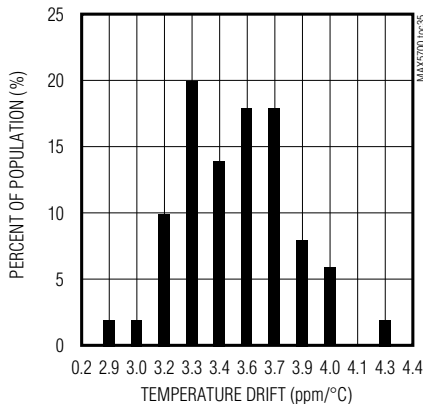

**REFERENCE LOAD REGULATION**

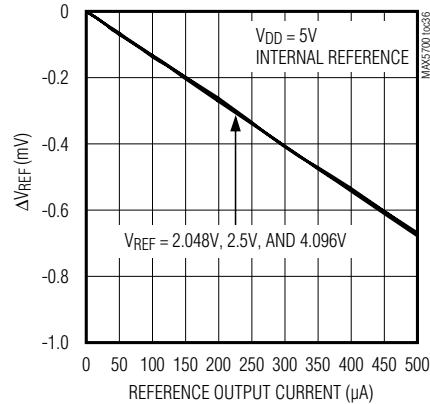

**SUPPLY CURRENT vs. LOGIC VOLTAGE**

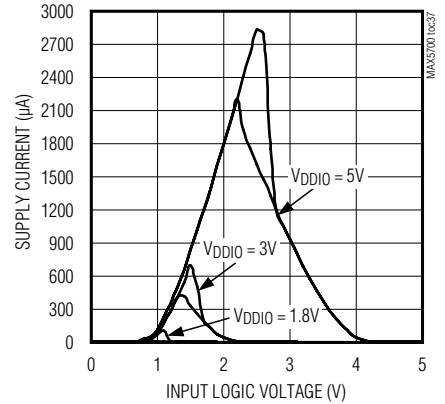

## Pin Configurations

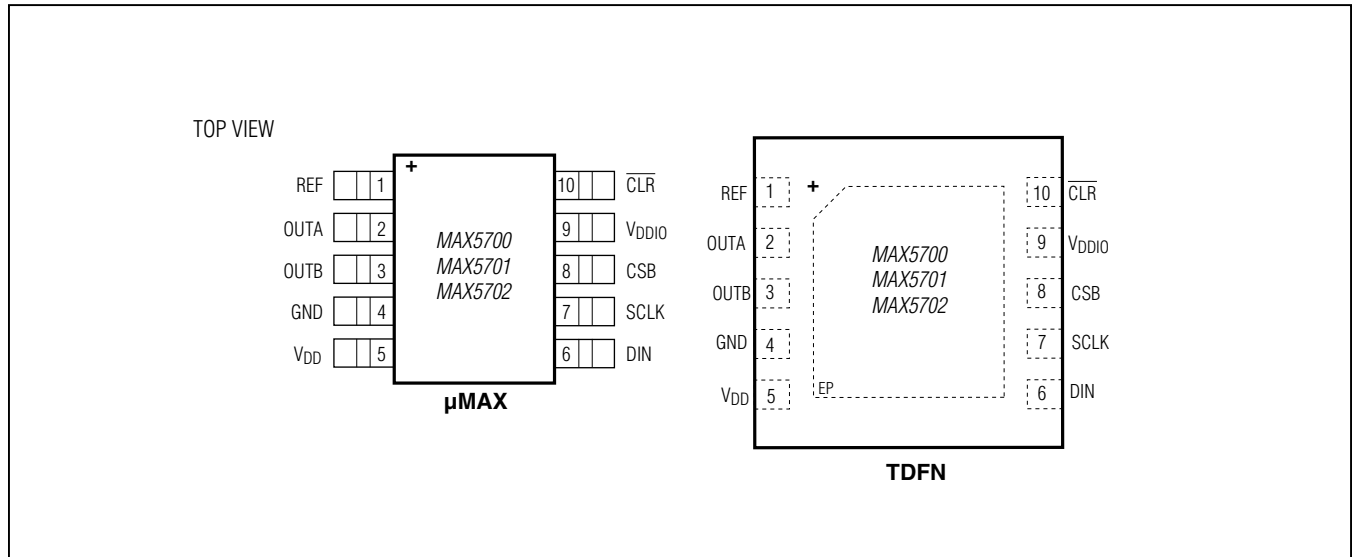

## Pin Description

PIN	NAME	FUNCTION
1	REF	Reference Voltage Input/Output
2	OUTA	Buffered Channel A DAC Output
3	OUTB	Buffered Channel B DAC Output
4	GND	Ground
5	V <sub>DD</sub>	Supply Voltage Input. Bypass V <sub>DD</sub> with at least a 0.1μF capacitor to GND.
6	DIN	SPI Interface Data Input
7	SCLK	SPI Interface Clock Input
8	CSB	SPI Chip-Select Input
9	V <sub>DDIO</sub>	Digital Interface Power-Supply Input
10	$\overline{\text{CLR}}$	Active-Low Clear Input
—	EP	Exposed Pad (TDFN Only). Connect to ground.

## Detailed Description

The MAX5700/MAX5701/MAX5702 are 2-channel, low-power, 8-/10-/12-bit buffered voltage-output DACs. The 2.7V to 5.5V wide supply voltage range and low-power consumption accommodates most low-power and low-voltage applications. The devices present a 100kΩ load to the external reference. The internal output buffers allow rail-to-rail operation. An internal voltage reference is available with software selectable options of 2.048V, 2.5V, or 4.096V. The devices feature a 50MHz, 3-wire SPI/QSPI/MICROWIRE/DSP-compatible serial interface to save board space and reduce the complexity in isolated applications. The MAX5700/MAX5701/MAX5702 include a serial-in/parallel-out shift register, internal CODE and DAC registers, a power-on-reset (POR) circuit to initialize the DAC outputs to code zero, and control logic.  $\overline{\text{CLR}}$  is available to asynchronously clear the device independent of the serial interface.

### DAC Outputs (OUT<sub>1</sub>)

The MAX5700/MAX5701/MAX5702 include internal buffers on all DAC outputs. The internal output buffers provide improved load regulation for the DAC outputs. The output buffers slew at 1V/μs (typ) and drive resistive loads as low as 2kΩ in parallel with as much as 500pF of capacitance. The analog supply voltage (V<sub>DD</sub>) determines the maximum output voltage range of the devices as V<sub>DD</sub> powers the output buffer. Under no-load conditions, the output buffers drive from GND to V<sub>DD</sub>, subject to offset and gain errors. With a 2kΩ load to GND, the output buffers drive from GND to within 200mV of V<sub>DD</sub>. With a 2kΩ load to V<sub>DD</sub>, the output buffers drive from V<sub>DD</sub> to within 200mV of GND.

The DAC ideal output voltage is defined by:

$$V_{\text{OUT}} = V_{\text{REF}} \times \frac{D}{2^N}$$

where D = code loaded into the DAC register, V<sub>REF</sub> = reference voltage, N = resolution.

### Internal Register Structure

The user interface is separated from the DAC logic to minimize digital feedthrough. Within the serial interface is an input shift register, the contents of which can be routed to control registers, individual, or multiple DACs as determined by the user command.

Within each DAC channel there is a CODE register followed by a DAC latch register (see the *Detailed*

*Functional Diagram*). The contents of the CODE register hold pending DAC output settings which can later be loaded into the DAC registers. The CODE register can be updated using both CODE and CODE\_LOAD user commands. The contents of the DAC register hold the current DAC output settings. The DAC register can be updated directly from the serial interface using the CODE\_LOAD commands or can upload the current contents of the CODE register using LOAD commands.

The contents of both CODE and DAC registers are maintained during power-down states, so that when the DACs are powered on, they return to their previously stored output settings. Any CODE or LOAD commands issued during power-down states continue to update the register contents. SW\_CLEAR and SW\_RESET commands reset the contents of all CODE and DAC registers to their zero-scale defaults.

### Internal Reference

The MAX5700/MAX5701/MAX5702 include an internal precision voltage reference that is software selectable to be 2.048V, 2.500V, or 4.096V. When an internal reference is selected, that voltage is available on the REF pin for other external circuitry (see the [Typical Operating Circuits](#)) and can drive a 25kΩ load.

### External Reference

The external reference input has a typical input impedance of 100kΩ and accepts an input voltage from +1.24V to V<sub>DD</sub>. Connect an external voltage supply between REF and GND to apply an external reference. The MAX5700/MAX5701/MAX5702 power up and reset to external reference mode. Visit [www.maximintegrated.com/products/references](http://www.maximintegrated.com/products/references) for a list of available external voltage-reference devices.

### Clear Input ( $\overline{\text{CLR}}$ )

The MAX5700/MAX5701/MAX5702 feature an asynchronous active-low  $\overline{\text{CLR}}$  logic input that simultaneously sets both DAC outputs to zero. Driving CLR low clears the contents of both the CODE and DAC registers and also aborts the on-going SPI command. To allow a new SPI command, drive  $\overline{\text{CLR}}$  high, satisfying the t<sub>CSC</sub> timing requirement.

### Interface Power Supply (V<sub>DDIO</sub>)

The MAX5700/MAX5701/MAX5702 feature a separate supply pin (V<sub>DDIO</sub>) for the digital interface (1.8V to 5.5V). Connect V<sub>DDIO</sub> to the I/O supply of the host processor.



**SPI Serial Interface**

The MAX5700/MAX5701/MAX5702 3-wire serial interface is compatible with MICROWIRE, SPI, QSPI, and DSPs. The interface provides three inputs, SCLK, CSB, and DIN. The chip-select input (CSB, active low) frames the data loaded through the serial data input (DIN). Following a CSB input high-to-low transition, the data is shifted in synchronously and latched into the input register on each falling edge of the serial clock input (SCLK). Each serial operation word is 24-bits long. The DAC data is left justified as shown in Table 1. The serial input register transfers its contents to the destination registers after loading 24 bits of data on the 24th SCLK falling edge. To initiate a new SPI operation, drive CSB high and then low to begin the next operation sequence, being sure to meet all relevant timing requirements. During CSB high periods, SCLK is ignored, allowing communication to other devices on the same bus. SPI operations consisting of more than 24 SCLK cycles are executed on the 24th SCLK falling edge, using the first three bytes of data available. SPI operations consisting of less than 24 SCLK cycles will not be executed. The content of the SPI operation consists of a command byte followed by a two byte data word.

Figure 1 shows the timing diagram for the complete 3-wire serial interface transmission. The DAC code settings (D) for the MAX5700/MAX5701/MAX5702 are accepted in an offset binary format (see Table 1). Otherwise, the expected data format for each command is listed in Table 2. See Figure 2 for an example of a typical SPI circuit application.

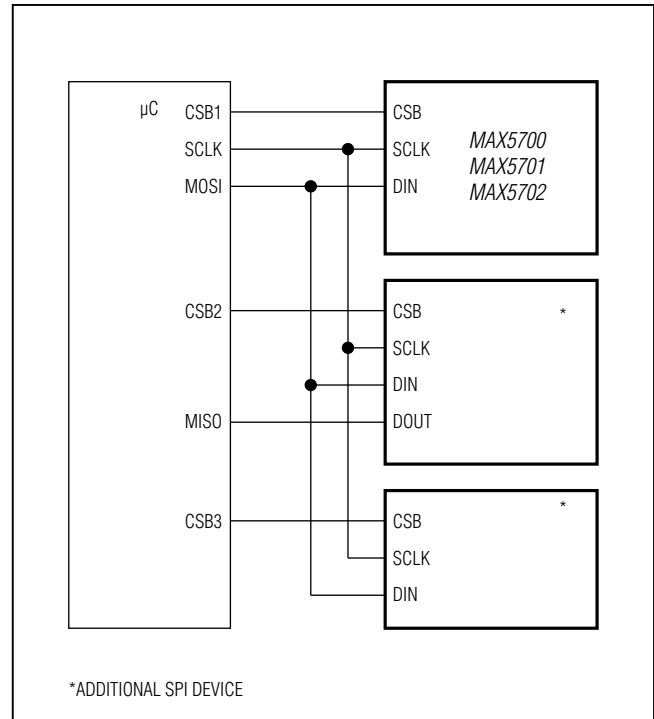

Figure 2. Typical SPI Application Circuit

**SPI User-Command Register Map**

This section lists the user accessible commands and registers for the MAX5700/MAX5701/MAX5702.

Table 2 provides detailed information about the Command Registers.

**Table 1. Format DAC Data Bit Positions**

PART	B15	B14	B13	B12	B11	B10	B9	B8	B7	B6	B5	B4	B3	B2	B1	B0
MAX5700	D7	D6	D5	D4	D3	D2	D1	D0	x	x	x	x	x	x	x	x
MAX5701	D9	D8	D7	D6	D5	D4	D3	D2	D1	D0	x	x	x	x	x	x
MAX5702	D11	D10	D9	D8	D7	D6	D5	D4	D3	D2	D1	D0	x	x	x	x





Table 2. SPI Commands Summary (continued)

COMMAND	B23	B22	B21	B20	B19	B18	B17	B16	B15	B14	B13	B12	B11	B10	B9	B8	B7	B6	B5	B4	B3	B2	B1	B0	DESCRIPTION
CONFIG	0	1	1	0	0	0	0	LD_EN	X	X	X	X	X	X	DAC B	DAC A	X	X	X	X	X	X	X	X	Sets the DAC Latch Mode of the selected DACs. Only DACs with a 1 in the selection bit are updated by the command. LD_EN = 0: DAC latch is operational (LOAD controlled) LD_EN = 1: DAC latch is transparent
REF	0	1	1	1	0	0	0	REF Mode 0 = EXT 01 = 2.5V 10 = 2.0V 11 = 4.1V	X	X	X	X	X	X	X	X	X	X	X	X	X	X	X	X	Sets the reference operating mode. REF Power (B18): 0 = Internal reference is only powered if at least one DAC is powered 1 = Internal reference is always powered
<b>ALL DAC COMMANDS</b>																									
CODE_ALL	1	0	0	0	0	0	0	0		CODE REGISTER DATA[11:4]						CODE REGISTER DATA[3:0]			Writes data to all CODE registers						
LOAD_ALL	1	0	0	0	0	0	1	1	X	X	X	X	X	X	X	X	X	X	X	X	X	X	X	X	Updates all DAC latches with current CODE register data
CODE_ALL_LOAD_ALL	1	0	0	0	0	0	1	X		CODE REGISTER DATA[11:4]						CODE REGISTER DATA[3:0]			Simultaneously writes data to all CODE registers while updating all DAC registers						
<b>NO OPERATION COMMANDS</b>																									
No Operation	1	0	0	1	X	X	X	X	X	X	X	X	X	X	X	X	X	X	X	X	X	X	X	X	These commands will have no effect on the device
Reserved Commands: Any commands not specifically listed above are reserved for Maxim internal use only.																									

**CODEn Command**

The CODEn command (B[23:20] = 0000) updates the CODE register contents for the selected DAC(s). Changes to the CODE register content based on this command will not affect DAC outputs directly unless the DAC latch has been configured to be transparent. Issuing the CODEn command with DAC SELECTION = ALL DACs is equivalent to CODE\_ALL (B[23:16] = 10000000). See [Table 2](#) and [Table 3](#).

**LOADn Command**

The LOADn command (B[23:20] = 0001) updates the DAC register content for the selected DAC(s) by uploading the current contents of the CODE register. The LOADn command can be used with DAC SELECTION = ALL DACs to issue a software load for all DACs, which is equivalent to the LOAD\_ALL (B[23:16] = 10000001) command. See [Table 2](#) and [Table 3](#).

**CODEn\_LOAD\_ALL Command**

The CODEn\_LOAD\_ALL command (B[23:20] = 0010) updates the CODE register contents for the selected DAC(s) as well as the DAC register content of all DACs. Channels for which the CODE register content has not been modified since the last load to DAC register operation will not be updated to reduce digital crosstalk. Issuing this command with DAC\_ADDRESS = ALL is equivalent to the CODE\_ALL\_LOAD\_ALL (B[23:16] = 1000001x) command. The CODEn\_LOAD\_ALL command by definition

will modify at least one CODE register. To avoid this, use the LOADn command with DAC SELECTION = ALL DACs or use the LOAD\_ALL command. See [Table 2](#) and [Table 3](#).

**CODEn\_LOADn Command**

The CODEn\_LOADn command (B[23:20] = 0011) updates the CODE register contents for the selected DAC(s) as well as the DAC register content of the selected DAC(s). Channels for which the CODE register content has not been modified since the last load to DAC register operation will not be updated to reduce digital crosstalk. Issuing this command with DAC SELECTION = ALL DACs is equivalent to the CODE\_ALL\_LOAD\_ALL command. See [Table 2](#) and [Table 3](#).

**CODE\_ALL Command**

The CODE\_ALL command (B[23:16] = 10000000) updates the CODE register contents for all DACs. See [Table 2](#).

**LOAD\_ALL Command**

The LOAD\_ALL command (B[23:16] = 10000001) updates the DAC register content for all DACs by uploading the current contents of the CODE registers. See [Table 2](#).

**CODE\_ALL\_LOAD\_ALL Command**

The CODE\_ALL\_LOAD\_ALL command (B[23:16] = 1000001x) updates the CODE register contents for all DACs as well as the DAC register content of all DACs. See [Table 2](#).

**Table 3. DAC Selection**

B19	B18	B17	B16	DAC SELECTED
0	0	0	0	DAC A
0	0	0	1	DAC B
0	0	1	X	No effect
X	1	X	X	ALL DACs
1	X	X	X	ALL DACs

**POWER Command**

The MAX5700/MAX5701/MAX5702 feature a software-controlled power-mode (POWER) command (B[23:18] = 010000). The POWER command updates the power-mode settings of the selected DACs while the power settings of the rest of the DACs remain unchanged. The new power setting is determined by bits B[17:16] while the affected DAC(s) are selected by bits B[9:8]. If all DACs are powered down, the device enters a STANDBY mode.

In power-down, the DAC output is disconnected from the buffer and is grounded with either one of the two selectable internal resistors or set to high impedance. See Table 5 for the selectable internal resistor values in power-down mode. In power-down mode, the DAC register retains its value so that the output is restored when the device powers up. The serial interface remains active in power-down mode.

In STANDBY mode, the internal reference can be powered down or it can be set to remain powered-on for external use. Also, in STANDBY mode, devices using the external reference do not load the REF pin. See Table 4.

**SW\_RESET and SW\_CLEAR Command**

The SW\_RESET (B[23:16] = 01010001) and SW\_CLEAR (B[23:16] = 01010000) commands provide a means of issuing a software reset or software clear operation. Use SW\_CLEAR to issue a software clear operation to return all CODE and DAC registers to the zero-scale value. Use SW\_RESET to reset all CODE, DAC, and configuration registers to their default values.

**Table 4. POWER Command Format**

B23	B22	B21	B20	B19	B18	B17	B16	B15	B14	B13	B12	B11	B10	B9	B8	B7	B6	B5	B4	B3	B2	B1	B0	
0	1	0	0	0	0	PD1	PD0	X	X	X	X	X	X	B	A	X	X	X	X	X	X	X	X	
POWER Command						Power Mode: 00 = Normal 01 = 1kΩ 10 = 100kΩ 11 = Hi-Z	Don't Care						Multiple DAC Selection: 1 = DAC Selected 0 = DAC Not Selected	Don't Care										
Default Values (all DACs) →						0	0	X	X	X	X	X	X	1	1	X	X	X	X	X	X	X	X	X

**Table 5. Selectable DAC Output Impedance in Power-Down Mode**

PD1 (B17)	PD0 (B16)	OPERATING MODE
0	0	Normal operation
0	1	Power-down with internal 1kΩ pulldown resistor to GND.
1	0	Power-down with internal 100kΩ pulldown resistor to GND.
1	1	Power-down with high-impedance output.

**CONFIG Command**

The CONFIG command (B[23:17] = 0110000) updates the LOAD functions of selected DACs. Issue the command with B16 = 0 to allow the DAC latches to operate normally or with B16 = 1 to disable the DAC latches, making them perpetually transparent. Mode settings of the selected DACs are updated while the mode settings of the rest of the DACs remain unchanged; DAC(s) are selected by bits B[9:8]. See [Table 6](#).

**REF Command**

The REF command updates the global reference setting used for all DAC channels. Set B[17:16] = 00 to use an external reference for the DACs or set B[17:16] to 01, 10, or 11 to select either the 2.5V, 2.048V, or 4.096V internal reference, respectively.

If RF2 (B18) is set to zero (default) in the REF command, the reference will be powered down any time all DAC channels are powered down (in STANDBY mode). If RF2 (B18 = 1) is set to one, the reference will remain powered even if all DAC channels are powered down, allowing continued operation of external circuitry. In this mode, the 1µA shutdown state is not available. See [Table 7](#).

**Table 6. CONFIG Command Format**

B23	B22	B21	B20	B19	B18	B17	B16	B15	B14	B13	B12	B11	B10	B9	B8	B7	B6	B5	B4	B3	B2	B1	B0		
0	1	1	0	0	0	0	LDB	X	X	X	X	X	X	B	A	X	X	X	X	X	X	X	X		
CONFIG Command							0 = Normal 1 = Transparent	Don't Care						Multiple DAC Selection: 1 = DAC Selected 0 = DAC Not Selected	Don't Care										
Default Values (all DACs) →							0	X	X	X	X	X	X	X	1	1	X	X	X	X	X	X	X	X	X

**Table 7. REF Command Format**

B23	B22	B21	B20	B19	B18	B17	B16	B15	B14	B13	B12	B11	B10	B9	B8	B7	B6	B5	B4	B3	B2	B1	B0
0	1	1	1	0	RF2	RF1	RF0	X	X	X	X	X	X	X	X	X	X	X	X	X	X	X	X
REF Command					0 = Off in Standby 1 = On in Standby	REF Mode: 00 = EXT 01 = 2.5V 10 = 2.0V 11 = 4.0V		Don't Care						Don't Care									
Default Values →					0	0	0	X	X	X	X	X	X	X	X	X	X	X	X	X	X	X	X

## Applications Information

### Power-On Reset (POR)

When power is applied to  $V_{DD}$  and  $V_{DDIO}$ , the DAC output is set to zero scale. To optimize DAC linearity, wait until the supplies have settled and the internal setup and calibration sequence completes (200 $\mu$ s, typ).

### Power Supplies and Bypassing Considerations

Bypass  $V_{DD}$  and  $V_{DDIO}$  with high-quality ceramic capacitors to a low-impedance ground as close as possible to the device. Minimize lead lengths to reduce lead inductance. Connect the GND to the analog ground plane.

### Layout Considerations

Digital and AC transient signals on GND can create noise at the output. Connect GND to form the star ground for the DAC system. Refer remote DAC loads to this system ground for the best possible performance. Use proper grounding techniques, such as a multilayer board with a low-inductance ground plane, or star connect all ground return paths back to the MAX5700/MAX5701/MAX5702 GND. Carefully layout the traces between channels to reduce AC cross-coupling. Do not use wire-wrapped boards and sockets. Use shielding to minimize noise immunity. Do not run analog and digital signals parallel to one another, especially clock signals. Avoid routing digital lines underneath the MAX5700/MAX5701/MAX5702 package.

## Definitions

### Integral Nonlinearity (INL)

INL is the deviation of the measured transfer function from a straight line drawn between two codes once offset and gain errors have been nullified.

### Differential Nonlinearity (DNL)

DNL is the difference between an actual step height and the ideal value of 1 LSB. If the magnitude of the DNL  $\leq$  1 LSB, the DAC guarantees no missing codes and is monotonic. If the magnitude of the DNL  $\geq$  1 LSB, the DAC output may still be monotonic.

### Offset Error

Offset error indicates how well the actual transfer function matches the ideal transfer function. The offset error is calculated from two measurements near zero code and near maximum code.

### Gain Error

Gain error is the difference between the ideal and the actual full-scale output voltage on the transfer curve, after nullifying the offset error. This error alters the slope of the transfer function and corresponds to the same percentage error in each step.

### Zero-Scale Error

Zero-scale error is the difference between the DAC output voltage when set to code zero and ground. This includes offset and other die level nonidealities.

### Full-Scale Error

Full-scale error is the difference between the DAC output voltage when set to full scale and the reference voltage. This includes offset, gain error, and other die level nonidealities.

### Settling Time

The settling time is the amount of time required from the start of a transition, until the DAC output settles to the new output value within the converter's specified accuracy.

### Digital Feedthrough

Digital feedthrough is the amount of noise that appears on the DAC output when the DAC digital control lines are toggled.

### Digital-to-Analog Glitch Impulse

A major carry transition occurs at the midscale point where the MSB changes from low to high and all other bits change from high to low, or where the MSB changes from high to low and all other bits change from low to high. The duration of the magnitude of the switching glitch during a major carry transition is referred to as the digital-to-analog glitch impulse.

The digital-to-analog power-up glitch is the duration of the magnitude of the switching glitch that occurs as the device exits power-down mode.

Detailed Functional Diagram

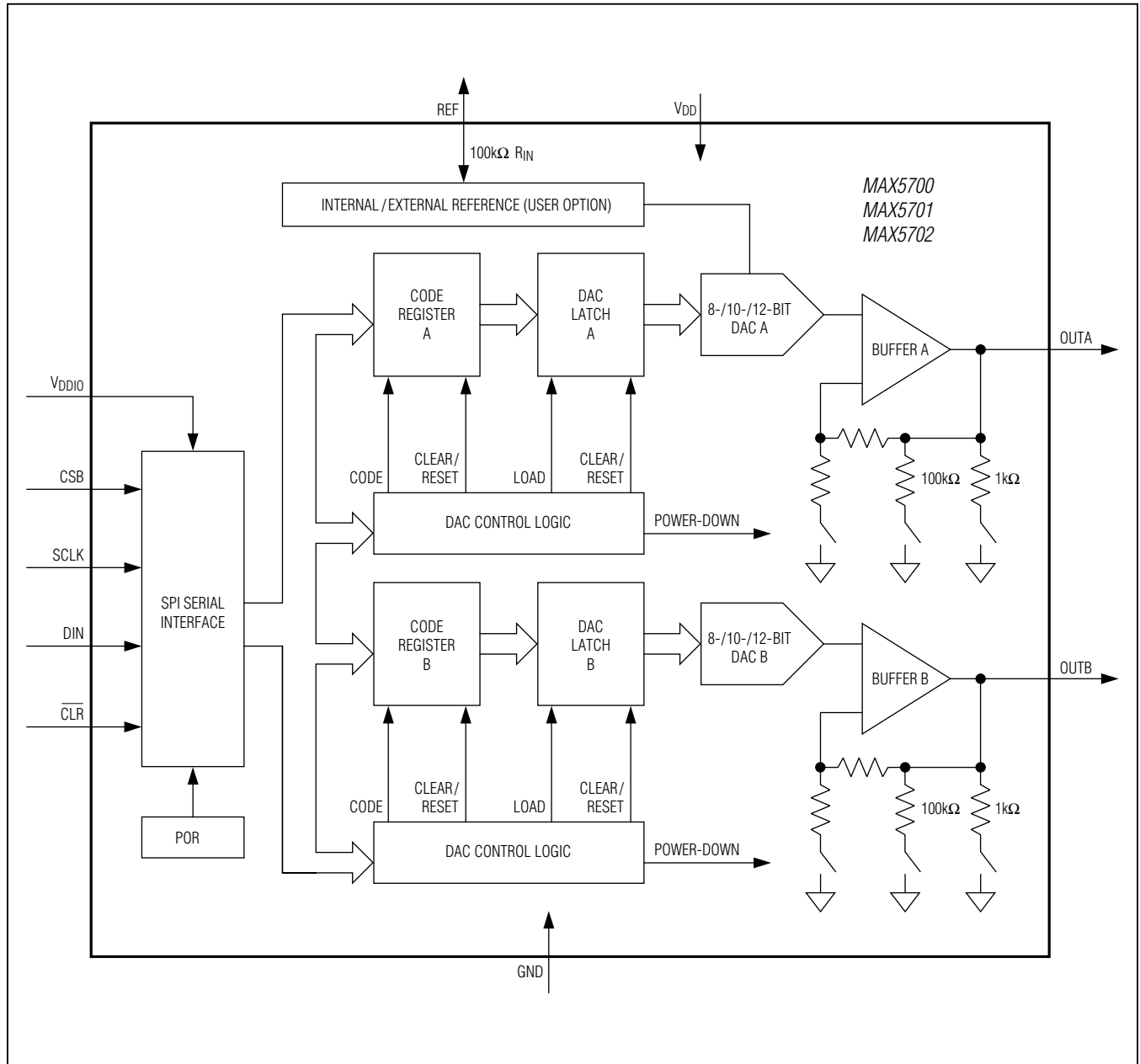

Typical Operating Circuits

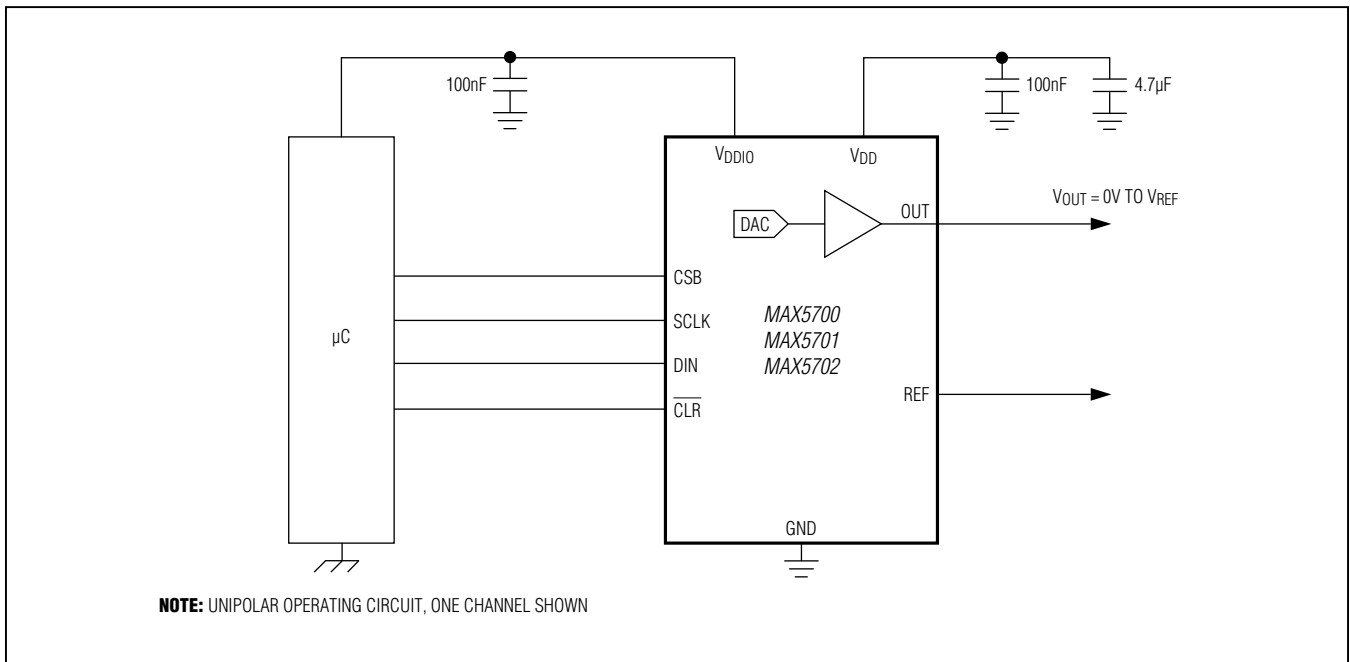
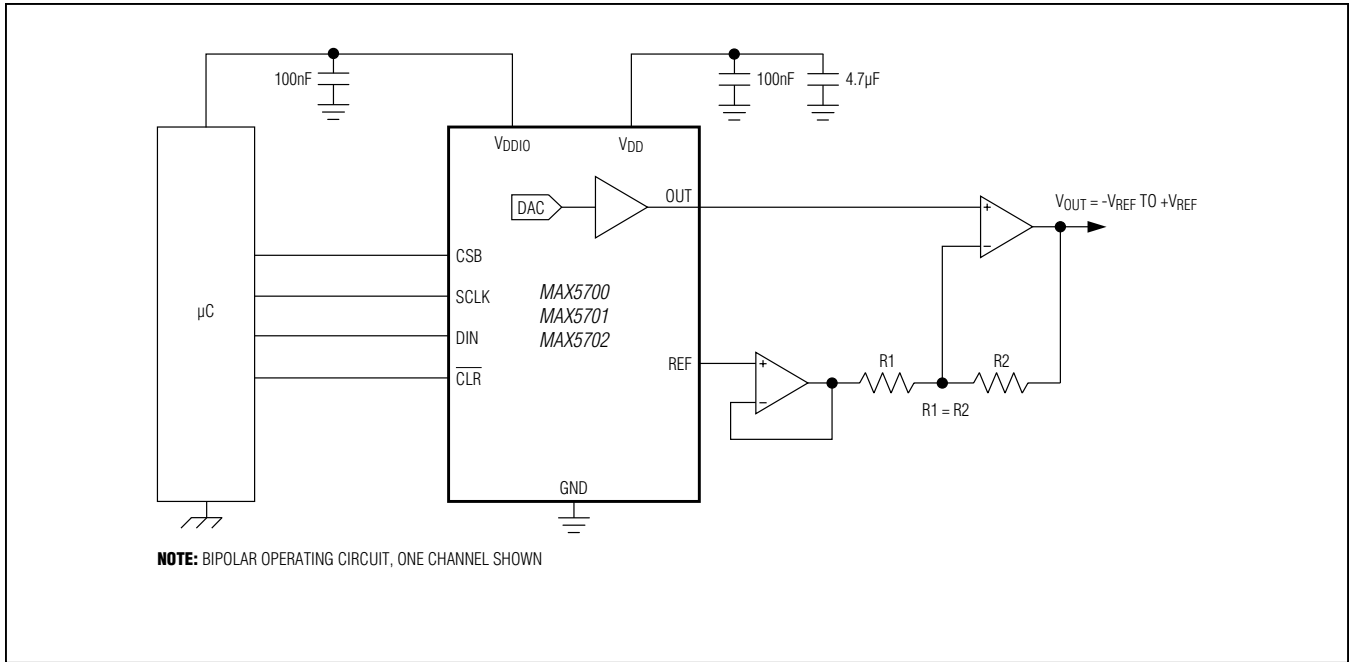



MAX5700/MAX5701/  
MAX5702

Ultra-Small, Dual-Channel, 8-/10-/12-Bit Buffered  
Output DACs with Internal Reference  
and SPI Interface

## Ordering Information

PART	PIN-PACKAGE	RESOLUTION (BIT)	INTERNAL REFERENCE TEMPCO (ppm/°C)
<b>MAX5700</b> ATB+T	10 TDFN-EP*	8	10 (typ), 25 (max)
MAX5700AUB+	10 $\mu$ MAX	8	10 (typ), 25 (max)
<b>MAX5701</b> ATB+T	10 TDFN-EP*	10	10 (typ), 25 (max)
MAX5701AUB+	10 $\mu$ MAX	10	10 (typ), 25 (max)
<b>MAX5702</b> AAUB+	10 $\mu$ MAX	12	3 (typ), 10 (max)
MAX5702BATB+T	10 TDFN-EP*	12	10 (typ), 25 (max)
MAX5702BAUB+	10 $\mu$ MAX	12	10 (typ), 25 (max)

**Note:** All devices are specified over the -40°C to +125°C temperature range.

+Denotes a lead(Pb)-free/RoHS-compliant package.

T = Tape and reel.

\*EP = Exposed pad.

## Chip Information

PROCESS: BiCMOS

## Package Information

For the latest package outline information and land patterns (footprints), go to [www.maximintegrated.com/packages](http://www.maximintegrated.com/packages). Note that a "+", "#", or "-" in the package code indicates RoHS status only. Package drawings may show a different suffix character, but the drawing pertains to the package regardless of RoHS status.

PACKAGE TYPE	PACKAGE CODE	OUTLINE NO.	LAND PATTERN NO.
10 $\mu$ MAX	U10+2	<a href="#">21-0061</a>	<a href="#">90-0330</a>
10 TDFN-EP	T1033+1	<a href="#">21-0137</a>	<a href="#">90-0003</a>

## Revision History

REVISION NUMBER	REVISION DATE	DESCRIPTION	PAGES CHANGED
0	9/12	Initial release	—
1	12/12	Updated <i>Electrical Characteristics</i> and <i>Ordering Information</i>	7, 25
2	8/13	Removed future product asterisks for $\mu$ MAX and TDFN products in the <i>Ordering Information</i> . Updated Input Capacitance in the <i>Electrical Characteristics</i> .	6, 25

Maxim Integrated cannot assume responsibility for use of any circuitry other than circuitry entirely embodied in a Maxim Integrated product. No circuit patent licenses are implied. Maxim Integrated reserves the right to change the circuitry and specifications without notice at any time. The parametric values (min and max limits) shown in the *Electrical Characteristics* table are guaranteed. Other parametric values quoted in this data sheet are provided for guidance.