

Features

- Designed for soft commutation only
- Maximum junction temperature: $T_J = 175\text{ }^\circ\text{C}$
- Minimized tail current
- $V_{CE(sat)} = 2.0\text{ V (typ.) @ } I_C = 25\text{ A}$
- Tight parameters distribution
- Safe paralleling
- Low V_F soft recovery co-packaged diode
- Low thermal resistance
- Lead free package

Applications

- Induction heating
- Microwave oven
- Resonant converters

Description

These IGBTs are developed using an advanced proprietary trench gate field-stop structure and performance is optimized in both conduction and switching losses. A freewheeling diode with a low drop forward voltage is co-packaged. The result is a product specifically designed to maximize efficiency for any resonant and soft-switching application.

Figure 1. Internal schematic diagram

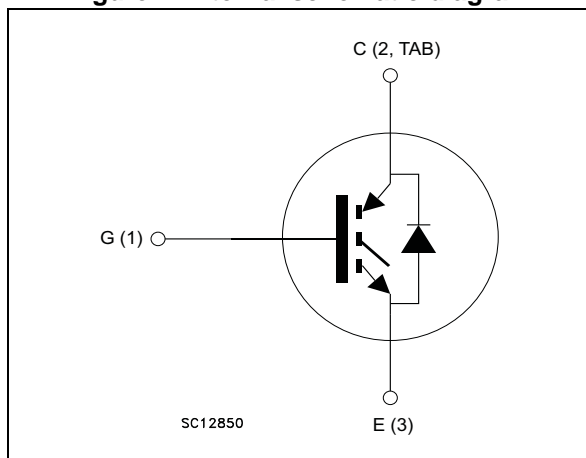

Table 1. Device summary

Order code	Marking	Package	Packaging
STGW28IH125DF	G28IH125DF	TO-247	Tube
STGWT28IH125DF	G28IH125DF	TO-3P	Tube

Contents

1	Electrical ratings	3
2	Electrical characteristics	4
	2.1 Electrical characteristics (curves)	6
3	Test circuits	11
4	Package mechanical data	12
5	Revision history	16

1 Electrical ratings

Table 2. Absolute maximum ratings

Symbol	Parameter	Value	Unit
V_{CES}	Collector-emitter voltage ($V_{GE} = 0$)	1250	V
I_C	Continuous collector current at $T_C = 25\text{ °C}$	60	A
I_C	Continuous collector current at $T_C = 100\text{ °C}$	30	A
$I_{CP}^{(1)}$	Pulsed collector current	120	A
V_{GE}	Gate-emitter voltage	± 20	V
I_F	Continuous forward current at $T_C = 25\text{ °C}$	60	A
I_F	Continuous forward current at $T_C = 100\text{ °C}$	30	A
$I_{FP(1)}$	Pulsed forward current	120	A
P_{TOT}	Total dissipation at $T_C = 25\text{ °C}$	375	W
T_{STG}	Storage temperature range	- 55 to 150	°C
T_J	Operating junction temperature	- 55 to 175	°C

1. Pulse width limited by maximum junction temperature.

Table 3. Thermal data

Symbol	Parameter	Value	Unit
R_{thJC}	Thermal resistance junction-case IGBT	0.4	°C/W
R_{thJC}	Thermal resistance junction-case diode	1.47	°C/W
R_{thJA}	Thermal resistance junction-ambient	50	°C/W

2 Electrical characteristics

T_J = 25 °C unless otherwise specified.

Table 4. Static characteristics

Symbol	Parameter	Test conditions	Min.	Typ.	Max.	Unit
V _{(BR)CES}	Collector-emitter breakdown voltage (V _{GE} = 0)	I _C = 2 mA	1250			V
V _{CE(sat)}	Collector-emitter saturation voltage	V _{GE} = 15 V, I _C = 25 A		2	2.5	V
		V _{GE} = 15 V, I _C = 25 A T _J = 125 °C		2.2		
		V _{GE} = 15 V, I _C = 25 A T _J = 175 °C		2.3		
		V _{GE} = 15 V, I _C = 50 A		2.65		
V _F	Forward on-voltage	I _F = 25 A		1.2	1.6	V
		I _F = 50 A		1.45		
		I _F = 25 A T _J = 125 °C		1.2		
		I _F = 25 A T _J = 175 °C		1.2		
V _{GE(th)}	Gate threshold voltage	V _{CE} = V _{GE} , I _C = 1 mA	5	6	7	V
I _{CES}	Collector cut-off current (V _{GE} = 0)	V _{CE} = 1250 V			25	μA
I _{GES}	Gate-emitter leakage current (V _{CE} = 0)	V _{GE} = ± 20 V			250	nA

Table 5. Dynamic characteristics

Symbol	Parameter	Test conditions	Min.	Typ.	Max.	Unit
C _{ies}	Input capacitance	V _{CE} = 25 V, f = 1 MHz, V _{GE} = 0	-	2035	-	pF
C _{oes}	Output capacitance		-	139	-	pF
C _{res}	Reverse transfer capacitance		-	52	-	pF
Q _g	Total gate charge	V _{CC} = 960 V, I _C = 25 A, V _{GE} = 15 V, see Figure 25	-	114	-	nC
Q _{ge}	Gate-emitter charge		-	11	-	nC
Q _{gc}	Gate-collector charge		-	69	-	nC

Table 6. IGBT switching characteristics (inductive load)

Symbol	Parameter	Test conditions	Min.	Typ.	Max.	Unit
$t_{d(off)}$	Turn-off delay time	$V_{CE} = 600\text{ V}$, $I_C = 25\text{ A}$, $R_G = 10\ \Omega$, $V_{GE} = 15\text{ V}$, see Figure 23	-	128	-	ns
t_f	Current fall time		-	82	-	ns
$E_{off}^{(1)}$	Turn-off switching losses		-	0.72	-	mJ
$t_{d(off)}$	Turn-off delay time	$V_{CE} = 600\text{ V}$, $I_C = 25\text{ A}$, $R_G = 10\ \Omega$, $V_{GE} = 15\text{ V}$, $T_J = 175\text{ }^\circ\text{C}$, see Figure 23	-	132	-	ns
t_f	Current fall time		-	190	-	ns
$E_{off}^{(1)}$	Turn-off switching losses		-	1.53	-	mJ

1. Turn-off losses include also the tail of the collector current.

Table 7. IGBT switching characteristics (capacitive load)

Symbol	Parameter	Test conditions	Min.	Typ.	Max.	Unit
$E_{off}^{(1)}$	Turn-off switching losses	$V_{CC} = 900\text{ V}$, $R_G = 10\ \Omega$, $I_C = 50\text{ A}$, $L = 500\ \mu\text{H}$, $C_{snub} = 330\text{ nF}$, see Figure 24	-	230	-	μJ
		$V_{CC} = 900\text{ V}$, $R_G = 10\ \Omega$, $I_C = 50\text{ A}$, $L = 500\ \mu\text{H}$, $C_{snub} = 330\text{ nF}$, $T_J = 175\text{ }^\circ\text{C}$, see Figure 24	-	520	-	

1. Turn-off losses include also the tail of the collector current.

2.1 Electrical characteristics (curves)

Figure 2. Power dissipation vs. case temperature

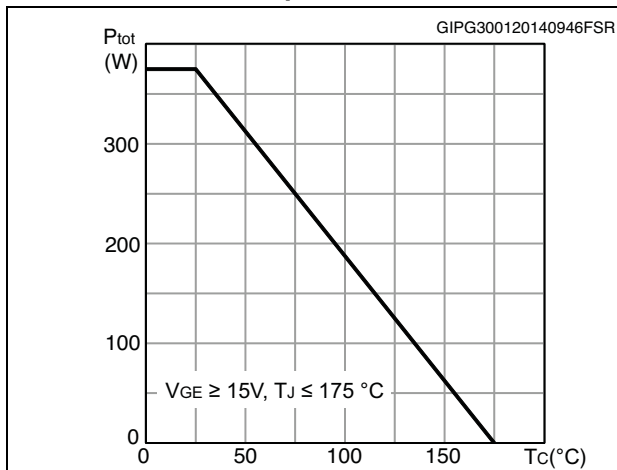

Figure 3. Collector current vs. case temperature

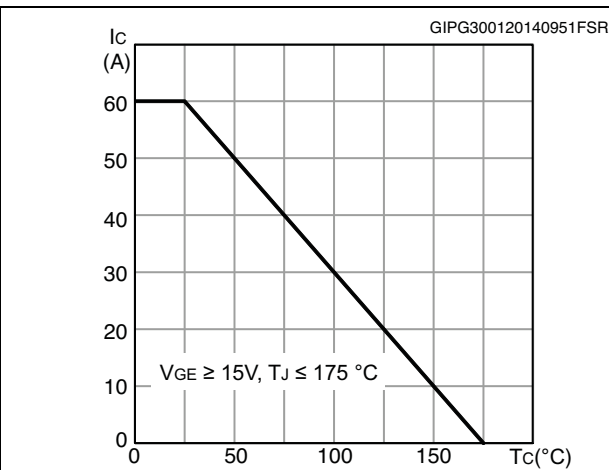

Figure 4. Output characteristics (T_J = 25°C)

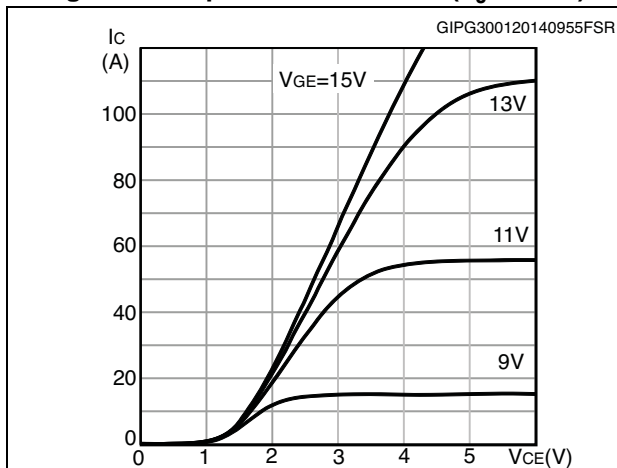

Figure 5. Output characteristics (T_J = 175°C)

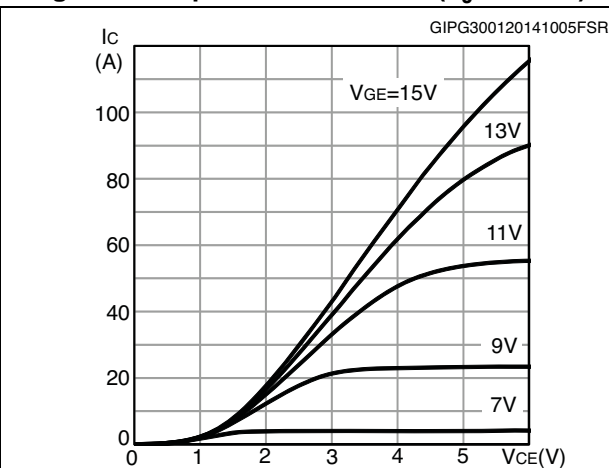

Figure 6. V_{CE(sat)} vs. junction temperature

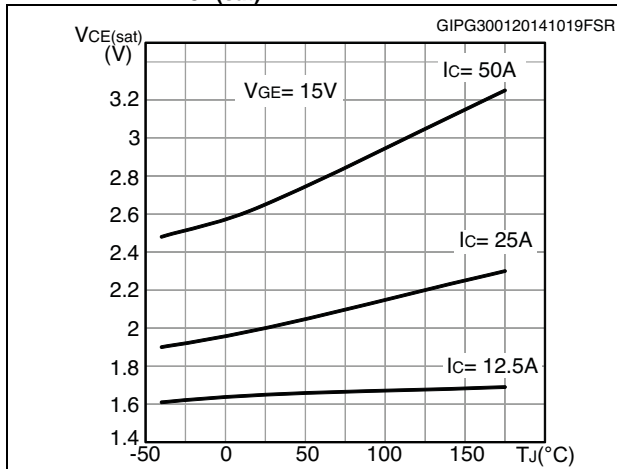

Figure 7. V_{CE(sat)} vs. collector current

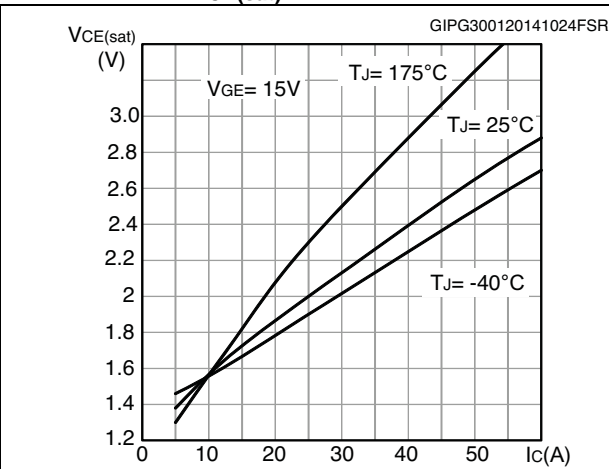

Figure 8. Forward bias safe operating area

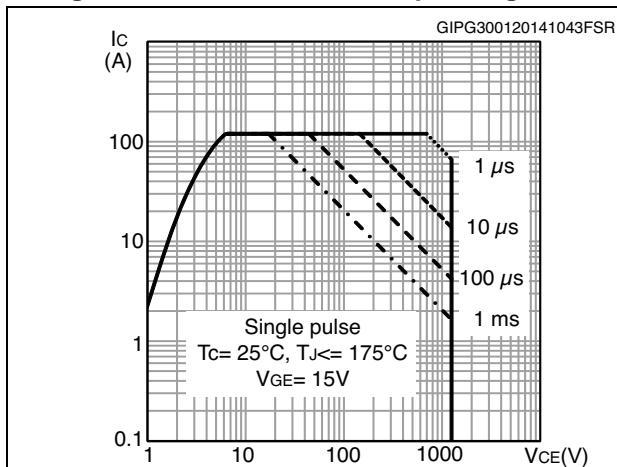

Figure 9. Transfer characteristics

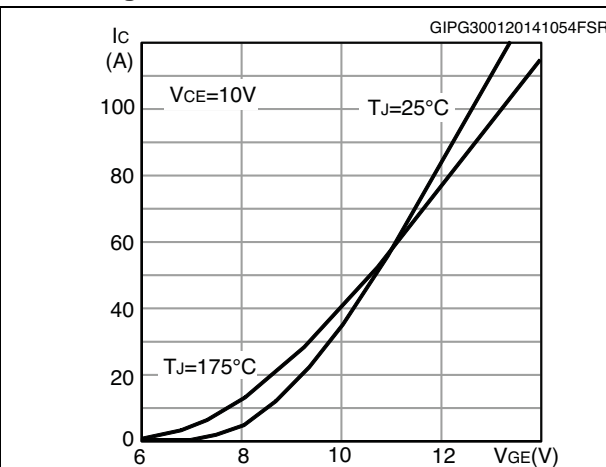

Figure 10. Diode VF vs. forward current

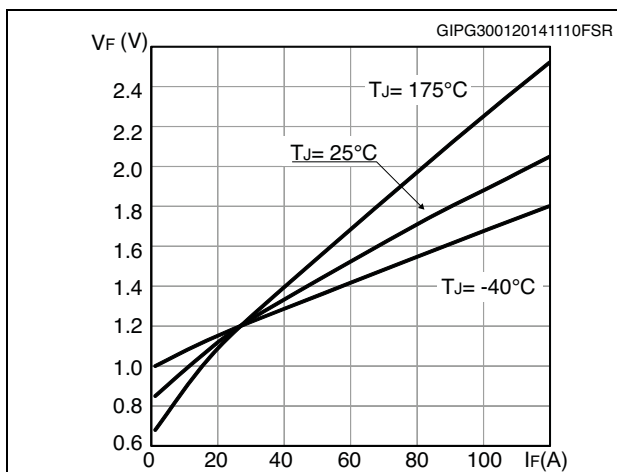

Figure 11. Normalized VGE(th) vs junction temperature

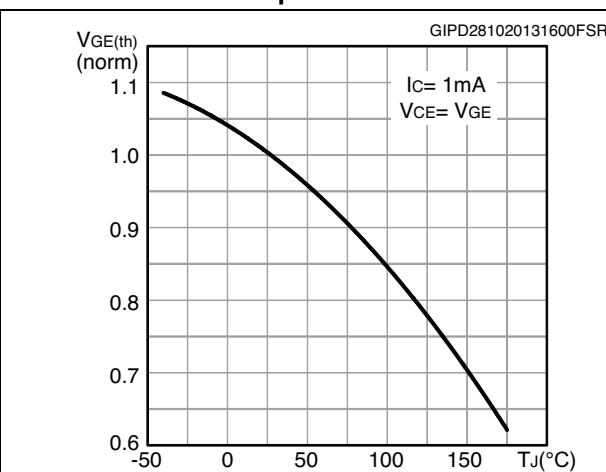

Figure 12. Normalized V(BR)CES vs. junction temperature

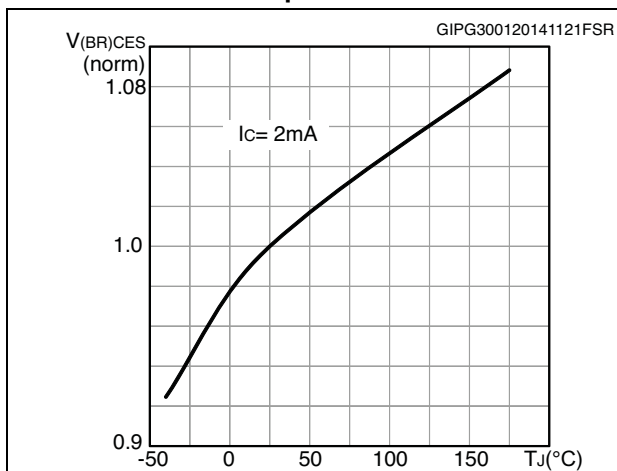

Figure 13. Capacitance variation

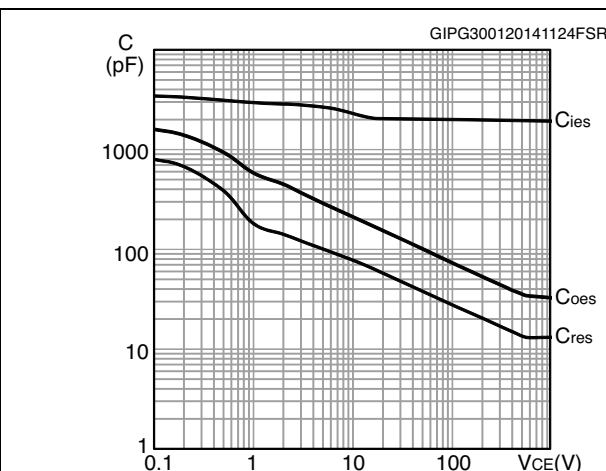

Figure 14. Gate charge vs. gate-emitter voltage

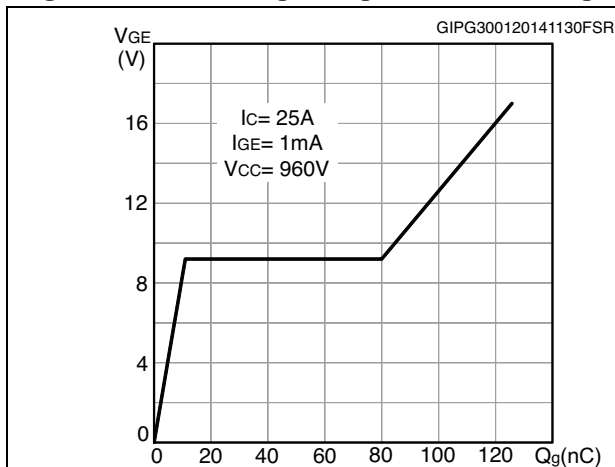

Figure 15. Switching loss vs collector current

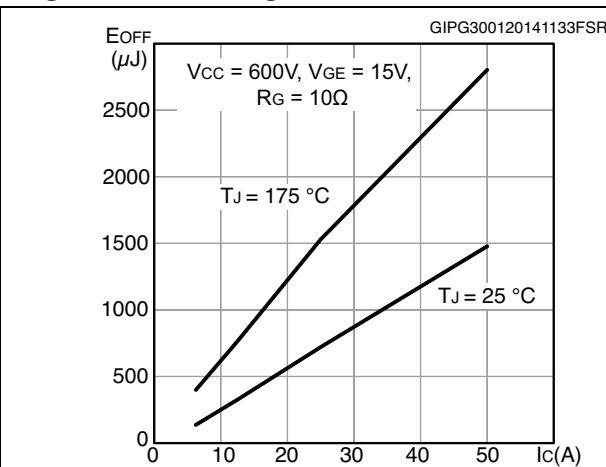

Figure 16. Switching loss vs gate resistance

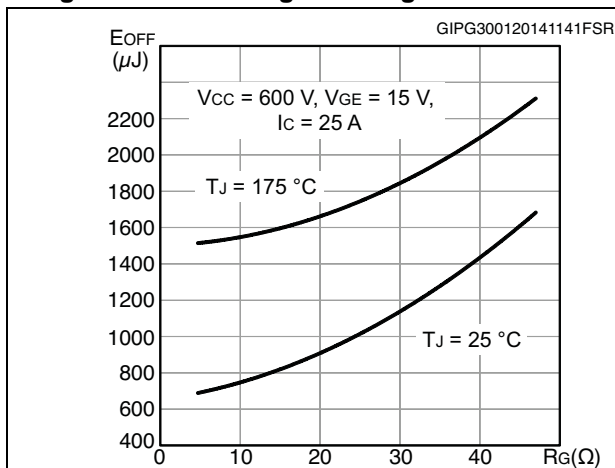

Figure 17. Switching loss vs temperature

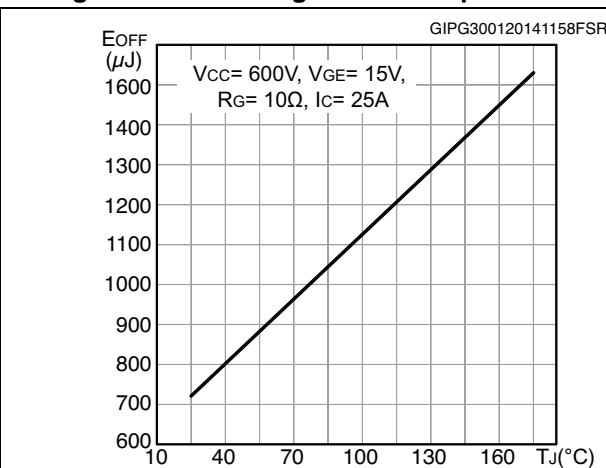

Figure 18. Switching loss vs collector-emitter voltage

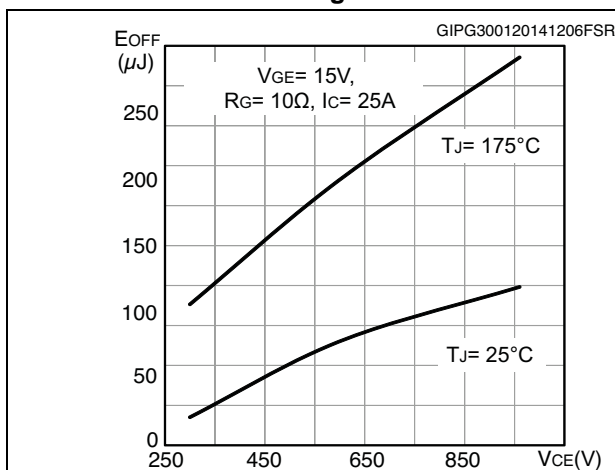

Figure 19. Switching times vs. collector current

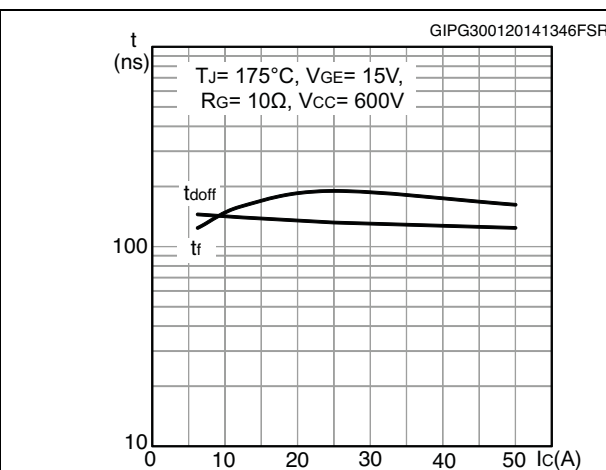

Figure 20. Switching times vs. gate resistance

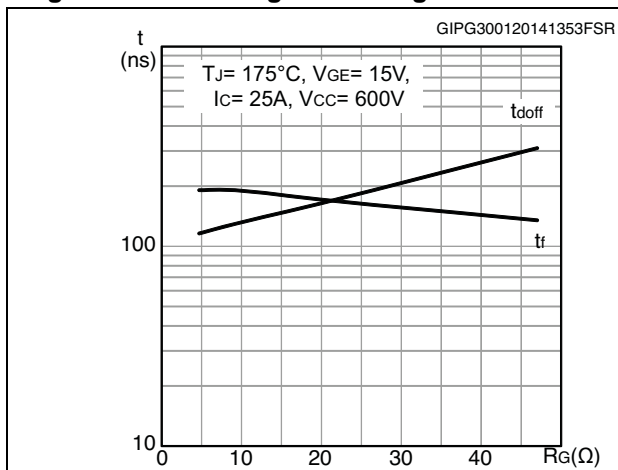

Figure 21. Thermal impedance for IGBT

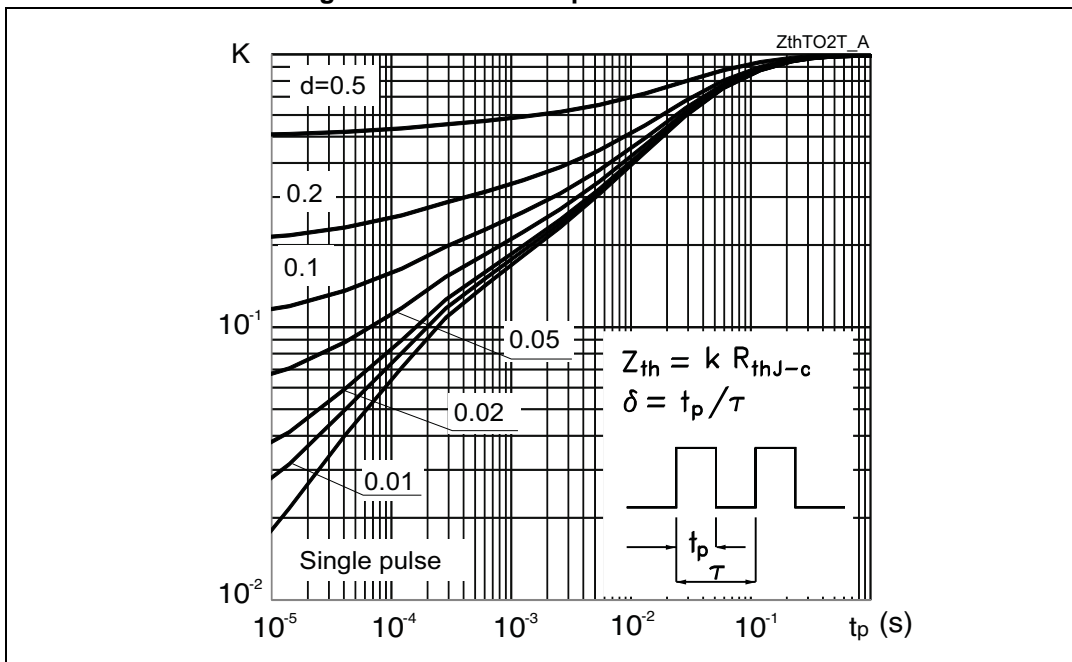
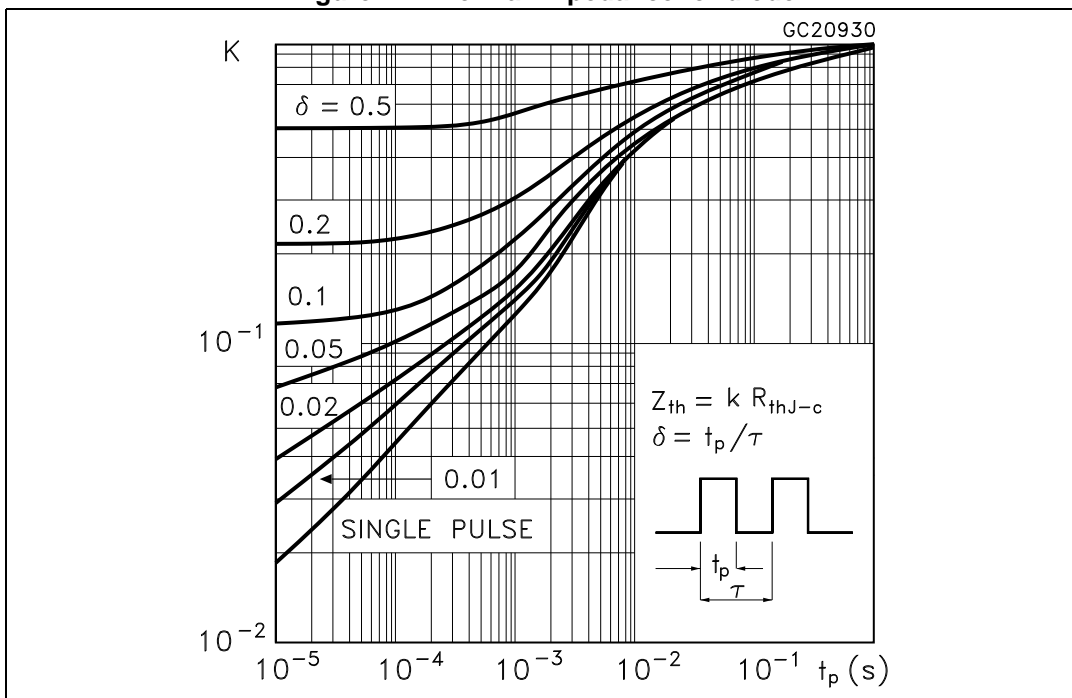

Figure 22. Thermal impedance for diode



3 Test circuits

Figure 23. Test circuit for inductive load switching



Figure 24. Test circuit for capacitive load switching

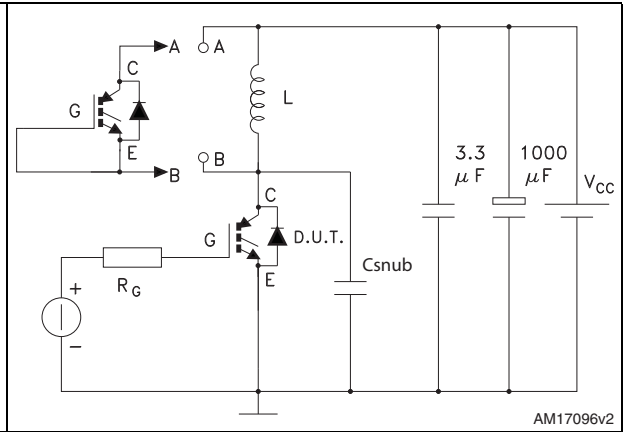

Figure 25. Gate charge test circuit

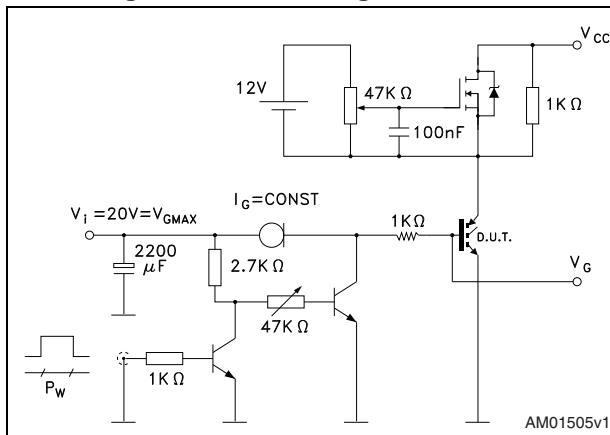
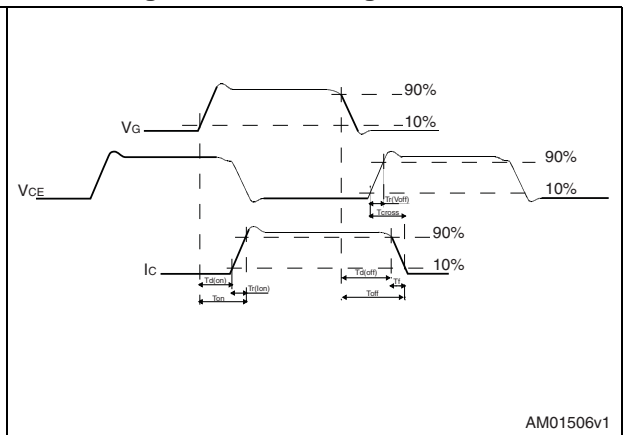

Figure 26. Switching waveform



4 Package mechanical data

In order to meet environmental requirements, ST offers these devices in different grades of ECOPACK® packages, depending on their level of environmental compliance. ECOPACK® specifications, grade definitions and product status are available at: www.st.com. ECOPACK is an ST trademark.

Figure 27. TO-247 drawing

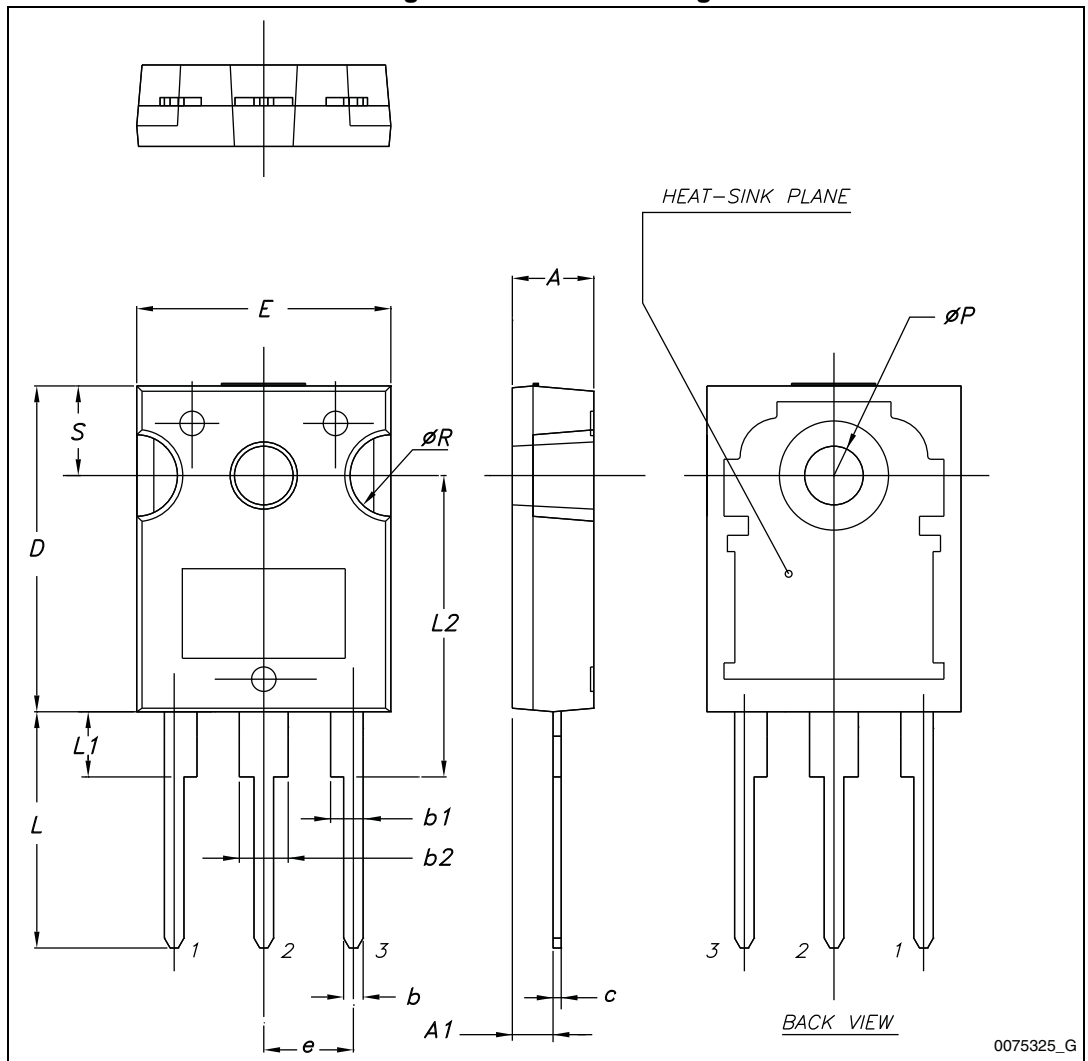

0075325_G

Table 8. TO-247 mechanical data

Dim.	mm.		
	Min.	Typ.	Max.
A	4.85		5.15
A1	2.20		2.60
b	1.0		1.40
b1	2.0		2.40
b2	3.0		3.40
c	0.40		0.80
D	19.85		20.15
E	15.45		15.75
e	5.30	5.45	5.60
L	14.20		14.80
L1	3.70		4.30
L2		18.50	
ØP	3.55		3.65
ØR	4.50		5.50
S	5.30	5.50	5.70

Figure 28. TO-3P drawing

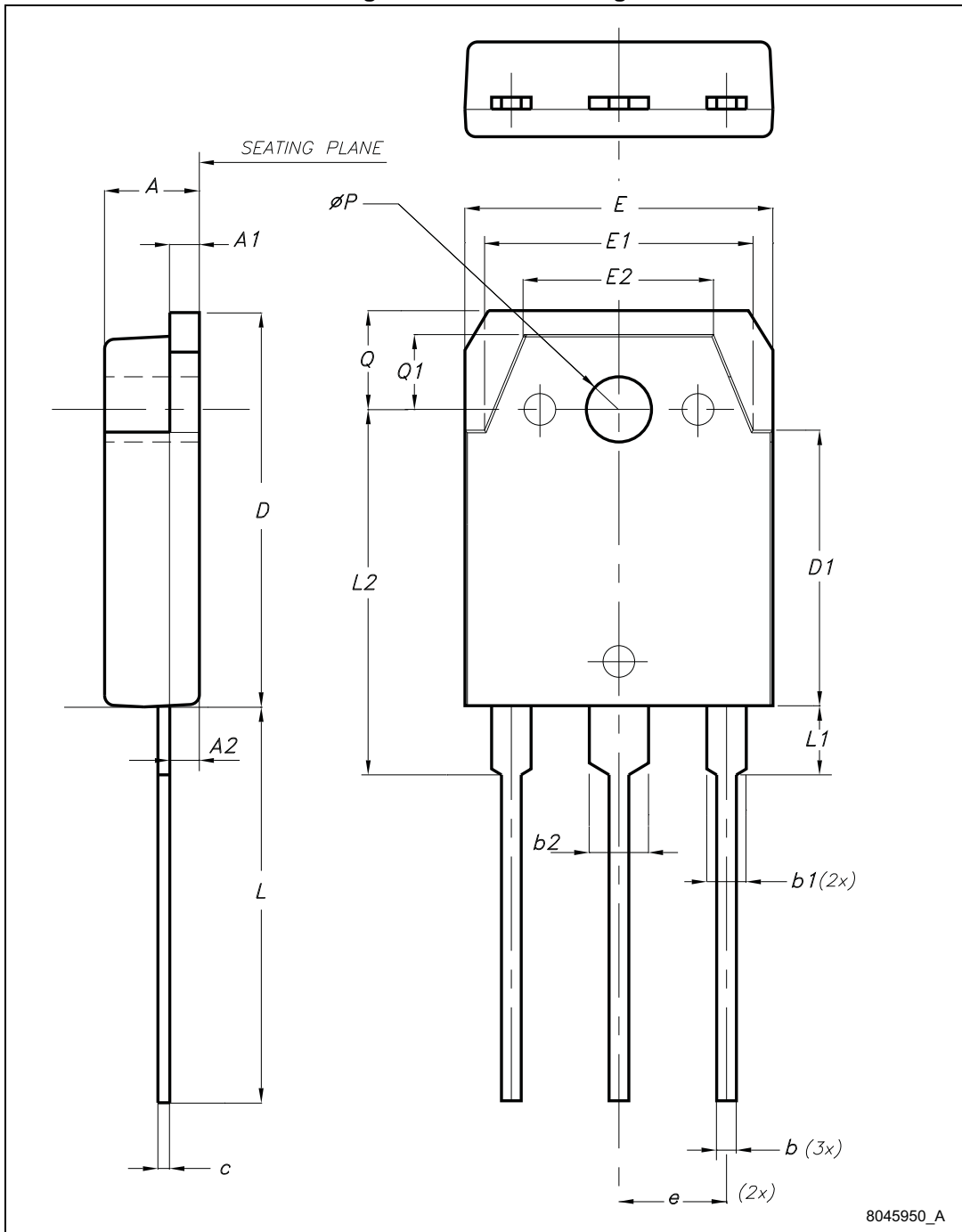

Table 9. TO-3P mechanical data

Dim.	mm		
	Min.	Typ.	Max.
A	4.60		5
A1	1.45	1.50	1.65
A2	1.20	1.40	1.60
b	0.80	1	1.20
b1	1.80		2.20
b2	2.80		3.20
c	0.55	0.60	0.75
D	19.70	19.90	20.10
D1		13.90	
E	15.40		15.80
E1		13.60	
E2		9.60	
e	5.15	5.45	5.75
L	19.50	20	20.50
L1		3.50	
L2	18.20	18.40	18.60
øP	3.10		3.30
Q		5	
Q1		3.80	

5 Revision history

Table 10. Document revision history

Date	Revision	Changes
20-Jan-2014	1	Initial release.
03-Feb-2014	2	Document status promoted from preliminary to production data. Updated <i>Table 2: Absolute maximum ratings</i> , <i>Table 4: Static characteristics</i> , <i>Table 5: Dynamic characteristics</i> , <i>Table 6: IGBT switching characteristics (inductive load)</i> and <i>Table 7: IGBT switching characteristics (capacitive load)</i> . Inserted <i>Section 2.1: Electrical characteristics (curves)</i> . Minor text changes.

Please Read Carefully:

Information in this document is provided solely in connection with ST products. STMicroelectronics NV and its subsidiaries ("ST") reserve the right to make changes, corrections, modifications or improvements, to this document, and the products and services described herein at any time, without notice.

All ST products are sold pursuant to ST's terms and conditions of sale.

Purchasers are solely responsible for the choice, selection and use of the ST products and services described herein, and ST assumes no liability whatsoever relating to the choice, selection or use of the ST products and services described herein.

No license, express or implied, by estoppel or otherwise, to any intellectual property rights is granted under this document. If any part of this document refers to any third party products or services it shall not be deemed a license grant by ST for the use of such third party products or services, or any intellectual property contained therein or considered as a warranty covering the use in any manner whatsoever of such third party products or services or any intellectual property contained therein.

UNLESS OTHERWISE SET FORTH IN ST'S TERMS AND CONDITIONS OF SALE ST DISCLAIMS ANY EXPRESS OR IMPLIED WARRANTY WITH RESPECT TO THE USE AND/OR SALE OF ST PRODUCTS INCLUDING WITHOUT LIMITATION IMPLIED WARRANTIES OF MERCHANTABILITY, FITNESS FOR A PARTICULAR PURPOSE (AND THEIR EQUIVALENTS UNDER THE LAWS OF ANY JURISDICTION), OR INFRINGEMENT OF ANY PATENT, COPYRIGHT OR OTHER INTELLECTUAL PROPERTY RIGHT.

ST PRODUCTS ARE NOT DESIGNED OR AUTHORIZED FOR USE IN: (A) SAFETY CRITICAL APPLICATIONS SUCH AS LIFE SUPPORTING, ACTIVE IMPLANTED DEVICES OR SYSTEMS WITH PRODUCT FUNCTIONAL SAFETY REQUIREMENTS; (B) AERONAUTIC APPLICATIONS; (C) AUTOMOTIVE APPLICATIONS OR ENVIRONMENTS, AND/OR (D) AEROSPACE APPLICATIONS OR ENVIRONMENTS. WHERE ST PRODUCTS ARE NOT DESIGNED FOR SUCH USE, THE PURCHASER SHALL USE PRODUCTS AT PURCHASER'S SOLE RISK, EVEN IF ST HAS BEEN INFORMED IN WRITING OF SUCH USAGE, UNLESS A PRODUCT IS EXPRESSLY DESIGNATED BY ST AS BEING INTENDED FOR "AUTOMOTIVE, AUTOMOTIVE SAFETY OR MEDICAL" INDUSTRY DOMAINS ACCORDING TO ST PRODUCT DESIGN SPECIFICATIONS. PRODUCTS FORMALLY ESCC, QML OR JAN QUALIFIED ARE DEEMED SUITABLE FOR USE IN AEROSPACE BY THE CORRESPONDING GOVERNMENTAL AGENCY.

Resale of ST products with provisions different from the statements and/or technical features set forth in this document shall immediately void any warranty granted by ST for the ST product or service described herein and shall not create or extend in any manner whatsoever, any liability of ST.

ST and the ST logo are trademarks or registered trademarks of ST in various countries.

Information in this document supersedes and replaces all information previously supplied.

The ST logo is a registered trademark of STMicroelectronics. All other names are the property of their respective owners.

© 2014 STMicroelectronics - All rights reserved

STMicroelectronics group of companies

Australia - Belgium - Brazil - Canada - China - Czech Republic - Finland - France - Germany - Hong Kong - India - Israel - Italy - Japan - Malaysia - Malta - Morocco - Philippines - Singapore - Spain - Sweden - Switzerland - United Kingdom - United States of America

www.st.com

