



## Features

- (1) Wide band, High attenuation by 2-stage choke coil
- (2) Block terminal with cover  
Simple wire connection  
High safety by cover.

## Safety standard

- UL1283, CSA Std. C22. 2 No.8
- VDE0565 Teil. 3, Teil 3A2
- (VDE0565 will transfer to EN133200 on and after July 23, 2003.)

## Specifications

Item	Model	MXB-1206-33	MXB-1210-33	MXB-1220-33	MXB-1230-33
1	Rated voltage (AC, DC)	250V			
2	Rated current (AC, DC)	6A (Note 1)	10A (Note 1)	20A (Note 2)	30A (Note 2)
3	Test voltage (terminal to case, AC 1 minute)	2500V (25°C, 70% RH)			
4	Isolation resistance (terminal to case, 500VDC)	100MΩ min. (25°C, 70% RH)			
5	Leakage current	125V, 60Hz	0.5mA max.		
		250V, 60Hz	1mA max.		
6	DC resistance	0.3Ω max.	0.1Ω max.	0.02Ω max.	0.01Ω max.
7	Temperature rise	35°C max.		40°C max	
8	Operating temperature range	-25 ~ +85°C			
9	Operating humidity	30% ~ 90% RH (No dewdrop)			
10	Storage temperature	-30 ~ +85°C			
11	Storage humidity	10% ~ 95% RH (No dewdrop)			
12	Vibration	Sweep: 10 ~ 55 ~ 10Hz (for 1 minute), Amplitude: 1.5mm X, Y and Z axes for 2 hours			
13	Safety standard	Approved by UL1283, CSA C22.2 No. 8 (C-UL) and VDE0565 Teil3, Teil3A2			
14	Weight (typ)	220g	310g	530g	660g

(Note 1) : Value at Ta ≤ 50°C. Refer to the derating curve shown below at Ta > 50°C.  
(Note 2) : Value at Ta ≤ 45°C. Refer to the derating curve shown below at Ta > 45°C.

## Circuit

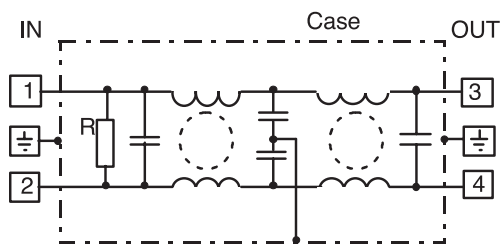

## Derating

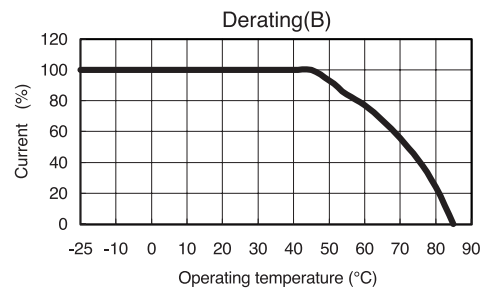
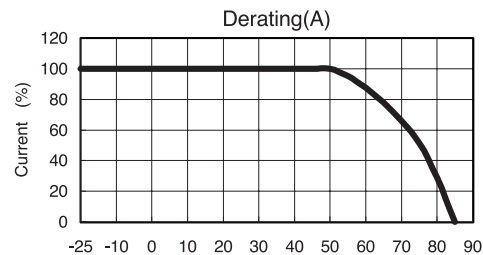

- Request customer specification for further details of specifications, outline, characteristics, etc.  
Read the instruction manual before usage.
- Contact us about delivery before ordering.

# MXB-SERIES

■ **MXB-1206-33**

■ **MXB-1210-33**

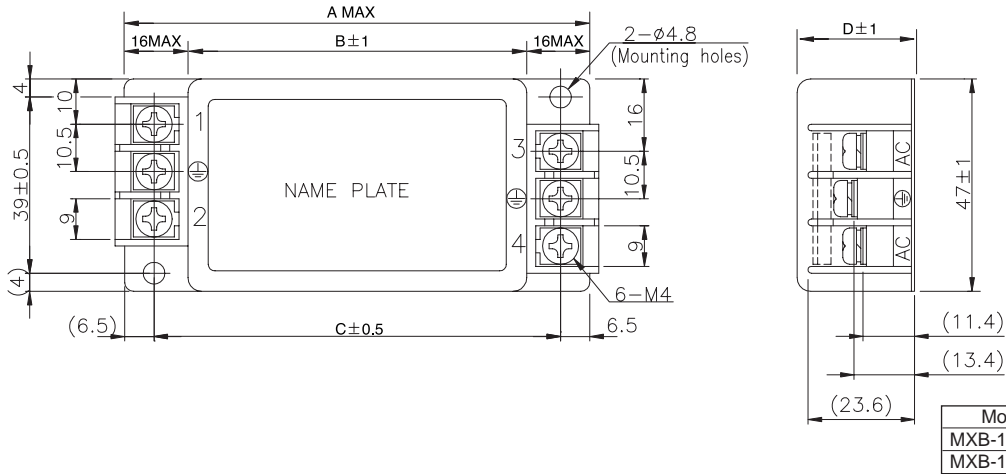

■ **MXB-1220-33**

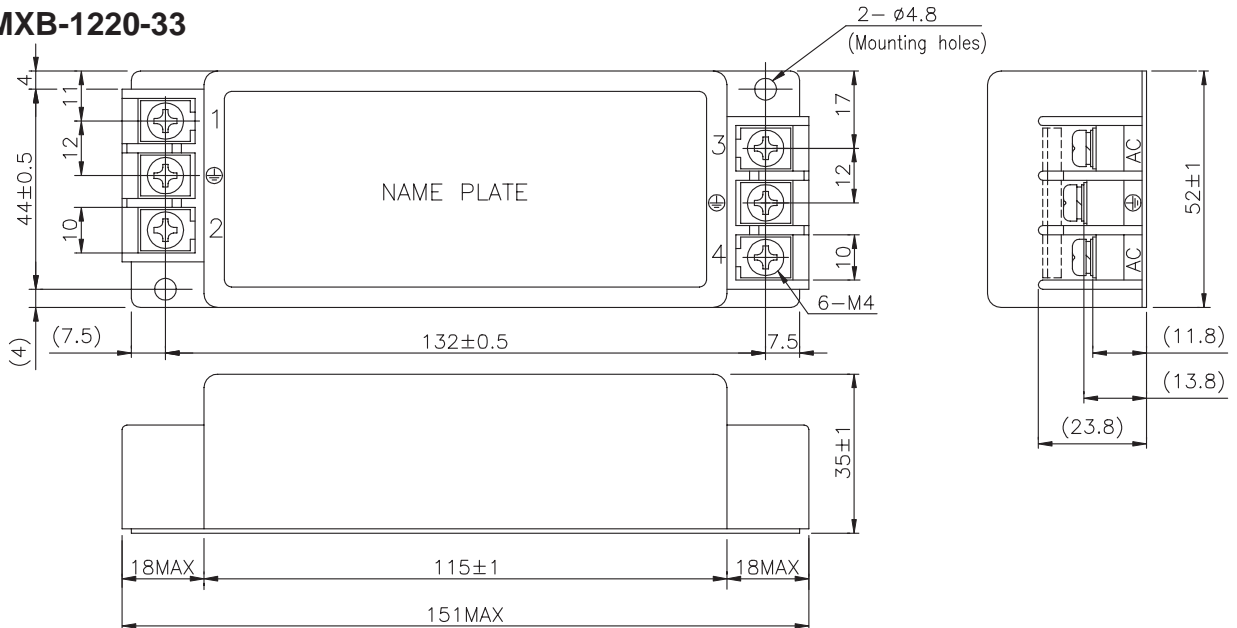

■ **MXB-1230-33**

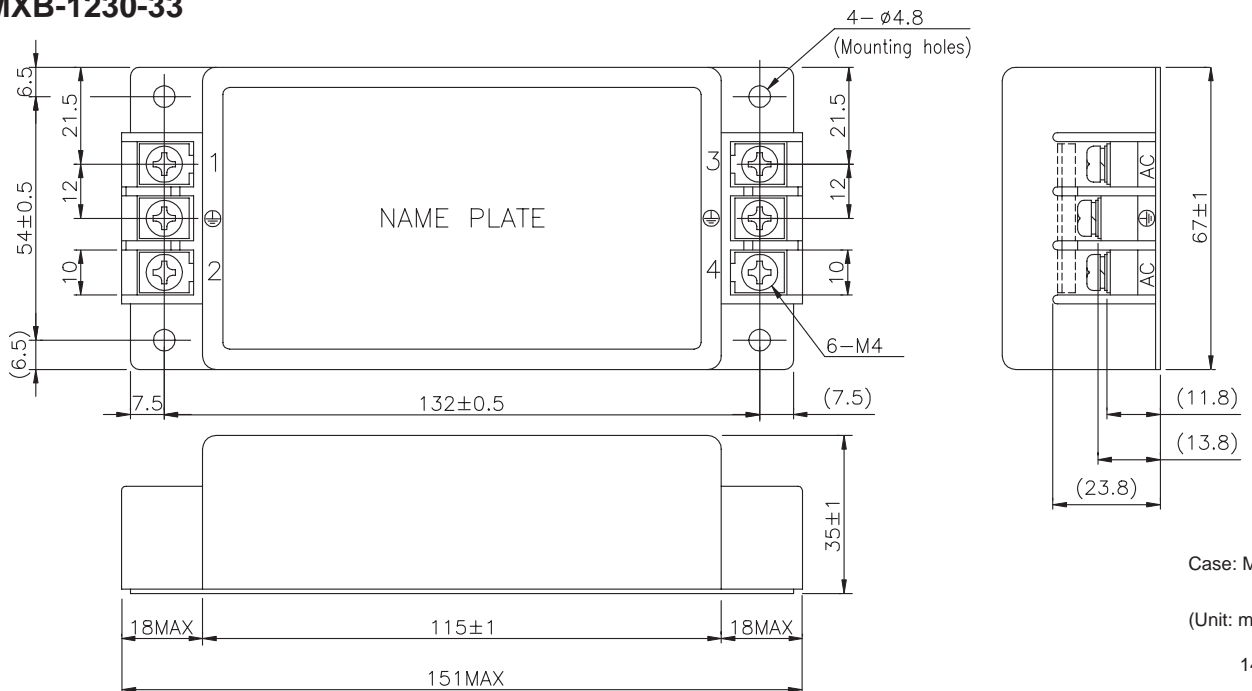

Case: Metal

(Unit: mm)

## CHARACTERISTICS

■ Typical Insertion Loss

(1) Asymmetrical

### MXB-1206-33

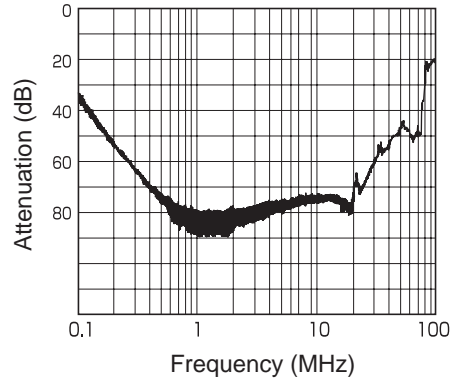
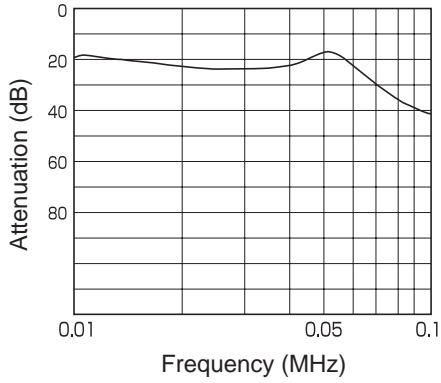

### MXB-1210-33

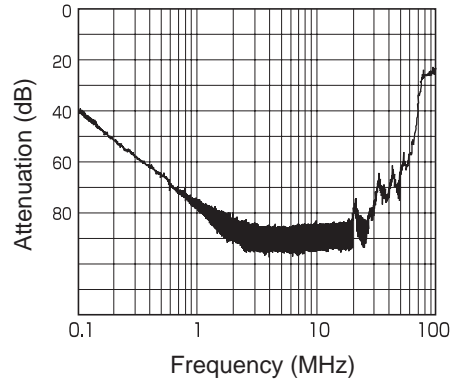
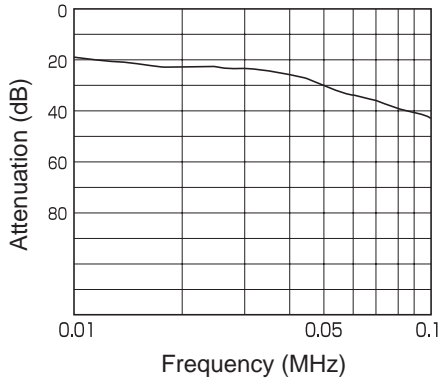

### MXB-1220-33

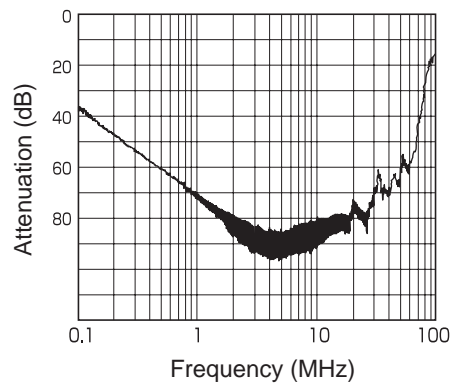
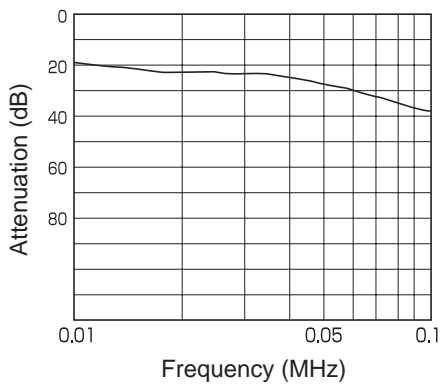

### MXB-1230-33

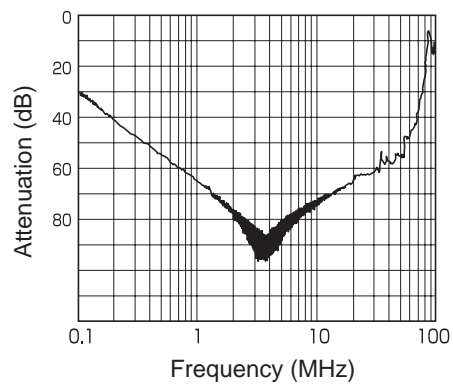
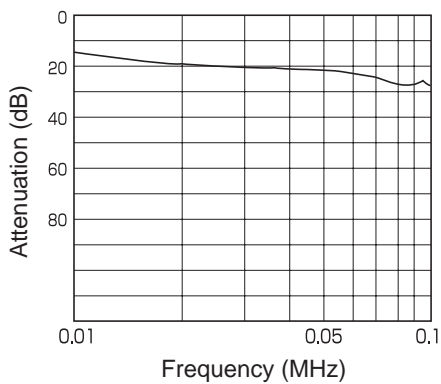

Noise Filter

## CHARACTERISTICS

■ Typical Insertion Loss

(2) Symmetrical

### MXB-1206-33

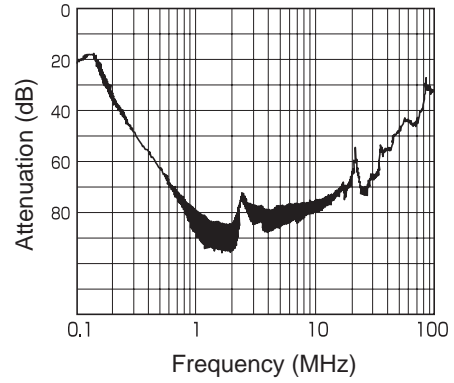
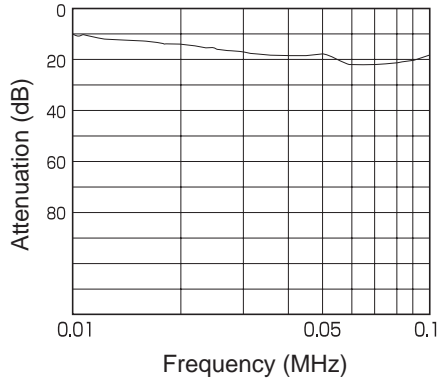

### MXB-1210-33

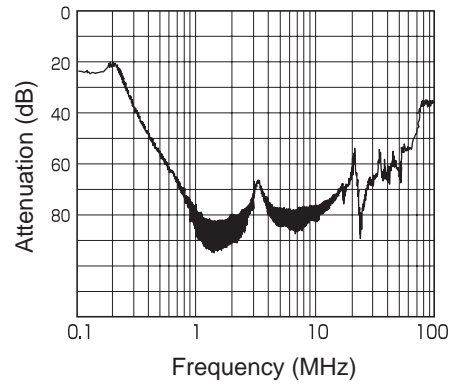
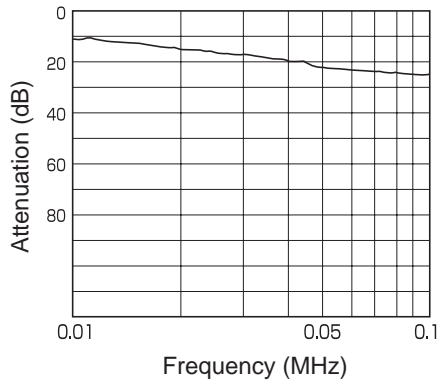

### MXB-1220-33

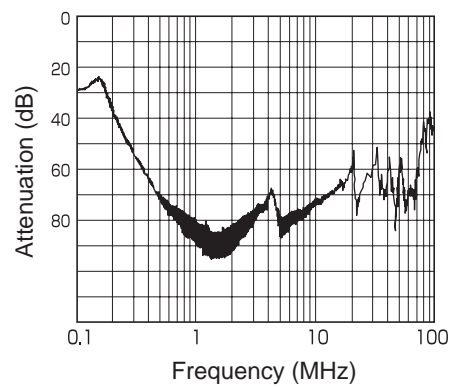
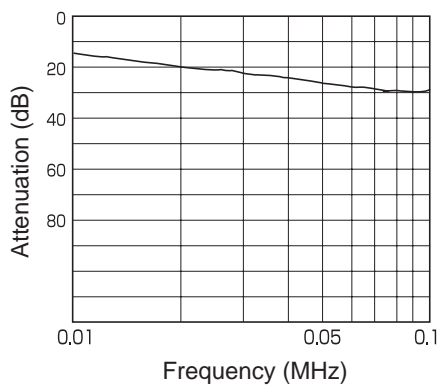

### MXB-1230-33

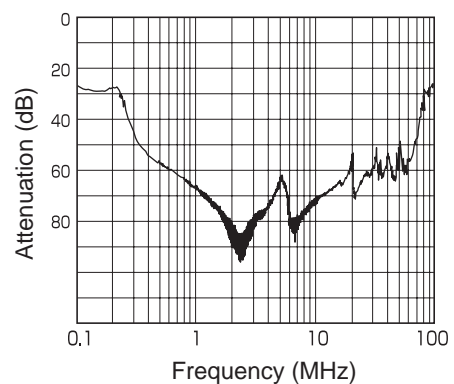
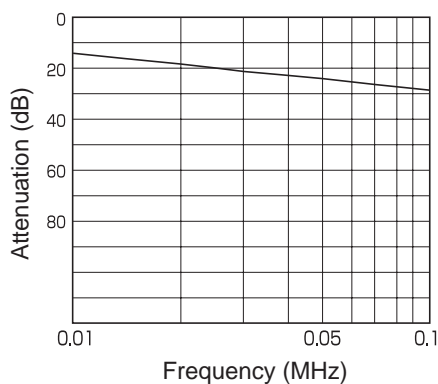

Noise Filter